

ZWS240BP

EVALUATION DATA

型式データ

DWG No. A253-53-01		
APPD	CHK	DWG
<i>m.</i> <i>Watanabe</i> 27. Jun. '12	<i>G.</i> <i>Sasaki</i> 26. Jun. '12	<i>a. Sakamoto</i> 26. Jun. '12

INDEX

1. 測定方法	Evaluation Method	PAGE	
1.1	測定回路	Circuit used for determination	
	測定回路1	Circuit 1 used for determination	T-1
	静特性	Steady state data	
	過電流保護特性	Over current protection (OCP) characteristics	
	過電圧保護特性	Over voltage protection (OVP) characteristics	
	出力立ち上がり特性	Output rise characteristics	
	出力立ち下がり特性	Output fall characteristics	
	出力保持時間特性	Hold up time characteristics	
	測定回路2	Circuit 2 used for determination	T-1
	ON/OFFコントロール時出力立ち上がり、立ち下がり特性	Output rise, fall characteristics with ON/OFF Control	
	測定回路3	Circuit 3 used for determination	T-2
	過渡応答（負荷急変）特性	Dynamic load response characteristics	
	測定回路4	Circuit 4 used for determination	T-2
	入力サージ電流（突入電流）波形	Inrush current waveform	
	測定回路5	Circuit 5 used for determination	T-2
	リーク電流特性	Leakage current characteristics	
	測定回路6	Circuit 6 used for determination	T-3
	出力リップル、ノイズ波形	Output ripple and noise waveform	
	測定構成	Configuration used for determination	T-3
	EMI特性	Electro-Magnetic Interference characteristics	
	(a) 雑音端子電圧（帰還ノイズ）	Conducted Emission	
	(b) 雑音電界強度（放射ノイズ）	Radiated Emission	
1.2	使用測定機器	List of equipment used	T-4
1.3	評価負荷条件	Load condition	T-4

2. 特性データ Characteristics

2.1 静特性 Steady state data

(1) 入力・負荷・温度変動／出力起動・低下電圧

Regulation - line and load, Temperature drift

/ Start up voltage and Drop out voltage T-5

(2) 効率対出力電流 Efficiency vs. Output current T-6

(3) 入力電流対出力電流 Input current vs. Output current T-7

(4) 入力電力対出力電流 Input power vs. Output current T-8

2.2 過電流保護特性 Over current protection (OCP) characteristics T-9

2.3 過電圧保護特性 Over voltage protection (OVP) characteristics T-9

2.4 出力立ち上がり特性 Output rise characteristics T-10~11

2.5 出力立ち下がり特性 Output fall characteristics T-12

2.6 ON/OFFコントロール時出力立ち上がり、立ち下がり特性

Output rise, fall characteristics with ON/OFF Control T-13

標準品 ZWS240BP-*/R にて対応

For option model ZWS240BP-*/R

2.7 出力保持時間特性 Hold up time characteristics T-14

2.8 過渡応答（負荷急変）特性 Dynamic load response characteristics T-15~16

2.9 入力電圧瞬停特性 Response to brown out characteristics T-17~18

2.10 入力サージ電流（突入電流）波形 Inrush current waveform T-19

2.11 高調波成分 Input current harmonics T-20

2.12 入力電流波形 Input current waveform T-20

2.13 リーク電流特性 Leakage current characteristics T-21

2.14 出力リップル、ノイズ波形 Output ripple and noise waveform T-22

2.15 EMI 特性 Electro-Magnetic Interference characteristics T-23~26

使用記号 Terminology used

	定義	Definition
V_{in} 入力電圧	Input voltage
V_{out} 出力電圧	Output voltage
I_{in} 入力電流	Input current
I_{out} 出力電流	Output current
T_a 周囲温度	Ambient temperature
f 周波数	Frequency

1. 測定方法 Evaluation Method

1.1. 測定回路 Circuit used for determination

測定回路1 Circuit 1 used for determination

- 静特性 Steady state data
- 過電流保護特性 Over current protection (OCP) characteristics
- 過電圧保護特性 Over voltage protection (OVP) characteristics
- 出力立ち上がり特性 Output rise characteristics
- 出力立ち下がり特性 Output fall characteristics
- 出力保持時間特性 Hold up time characteristics

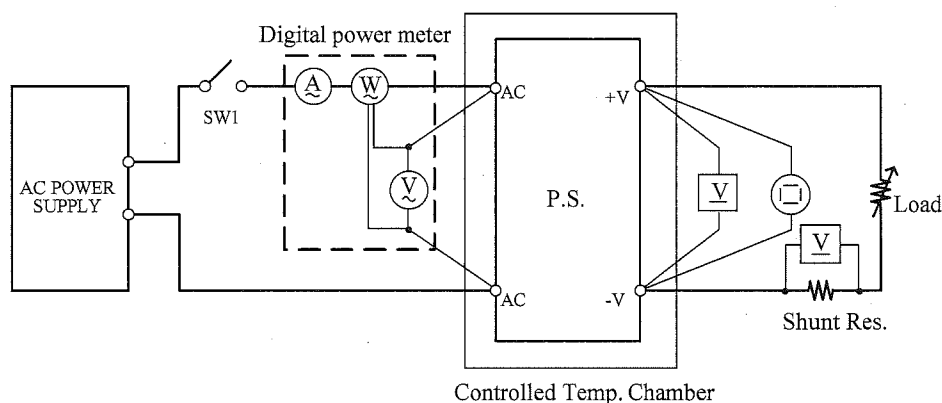

測定回路2 Circuit 2 used for determination

- ON/OFFコントロール時出力立ち上がり、立ち下がり特性
Output rise, fall characteristics with ON/OFF Control
- 準標準品 ZWS240BP-*/R にて対応
For option model ZWS240BP-*/R

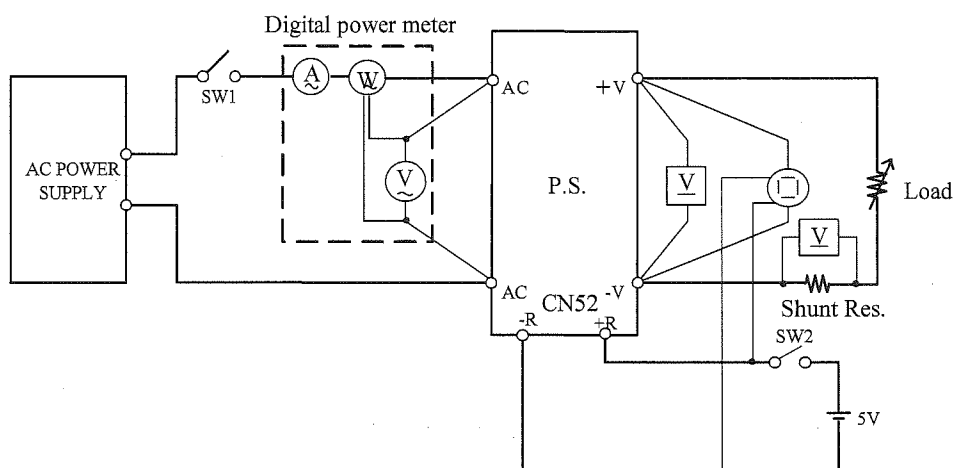

測定回路3 Circuit 3 used for determination

・過渡応答 (負荷急変) 特性 Dynamic load response characteristics

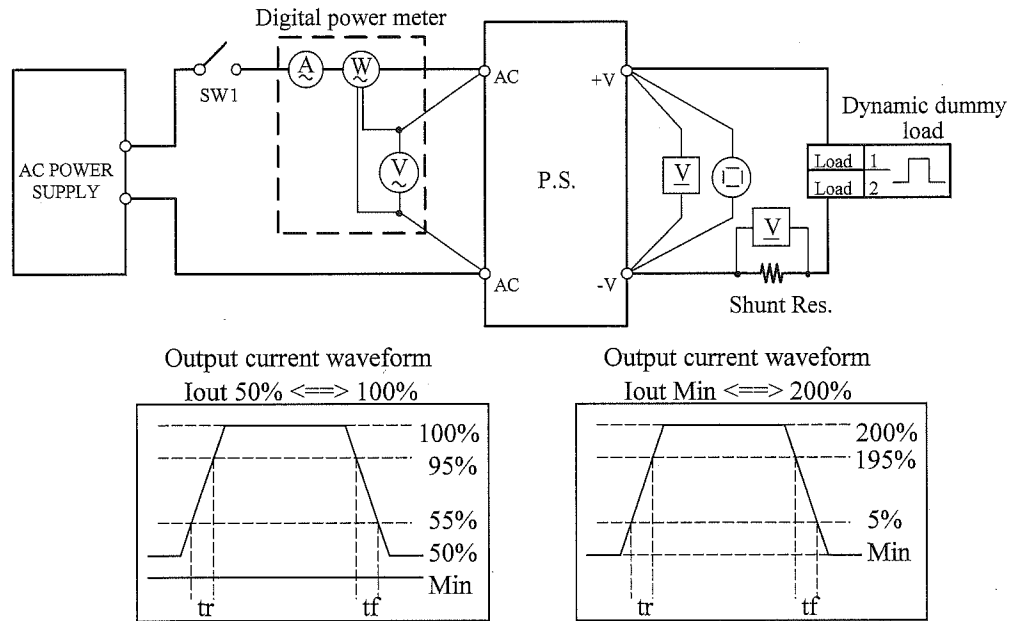

測定回路4 Circuit 4 used for determination

・入力サージ電流 (突入電流) 波形 Inrush current waveform

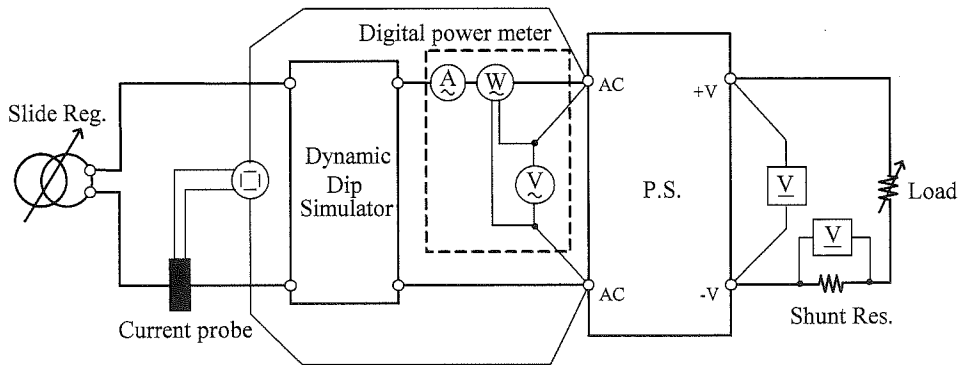

測定回路5 Circuit 5 used for determination

・リーク電流特性 Leakage current characteristics

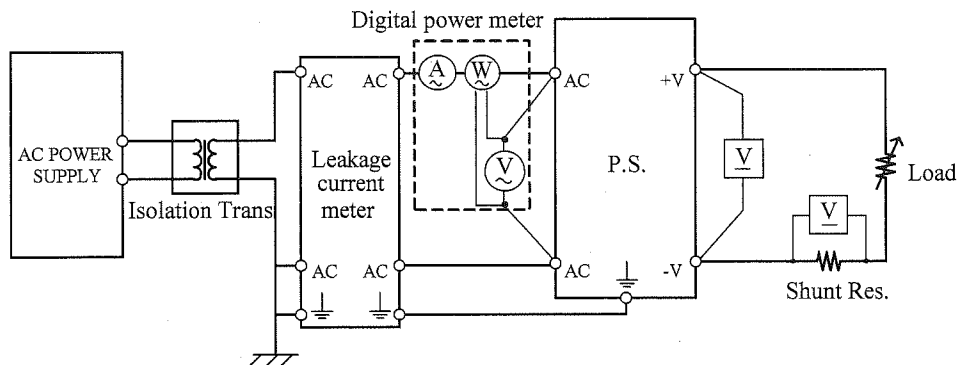

測定回路6 Circuit 6 used for determination

・出力リップル、ノイズ波形 Output ripple and noise waveform

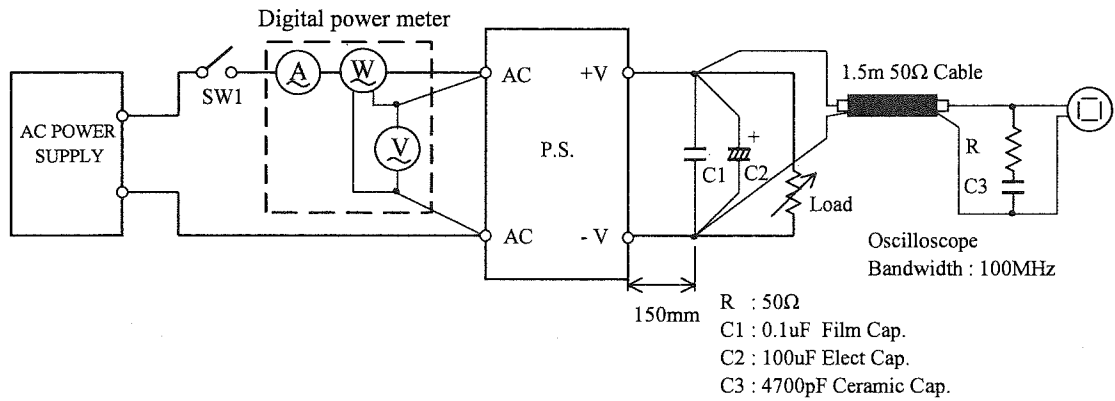

測定構成 Configuration used for determination

・EMI特性 Electro-Magnetic Interference characteristics

(a) 雑音端子電圧 (帰還ノイズ)

Conducted Emission

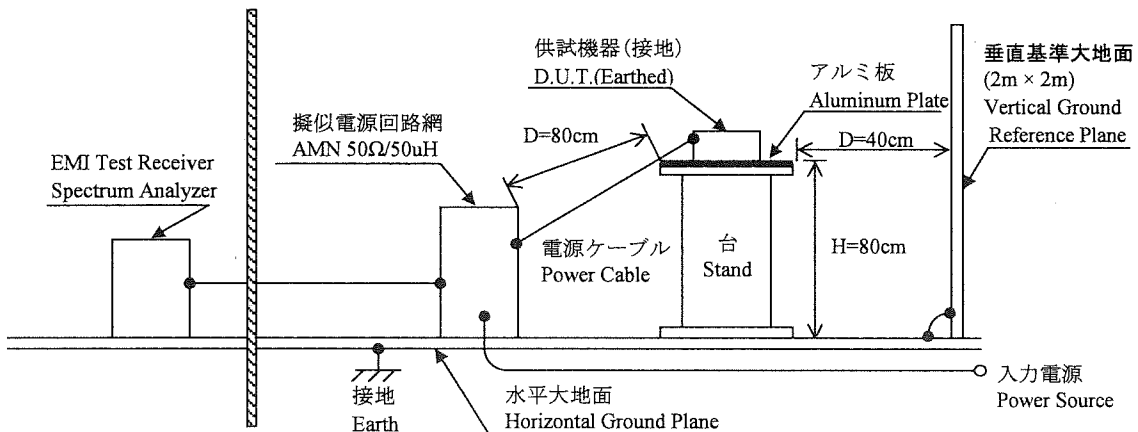

(b) 雑音電界強度 (放射ノイズ)

Radiated Emission

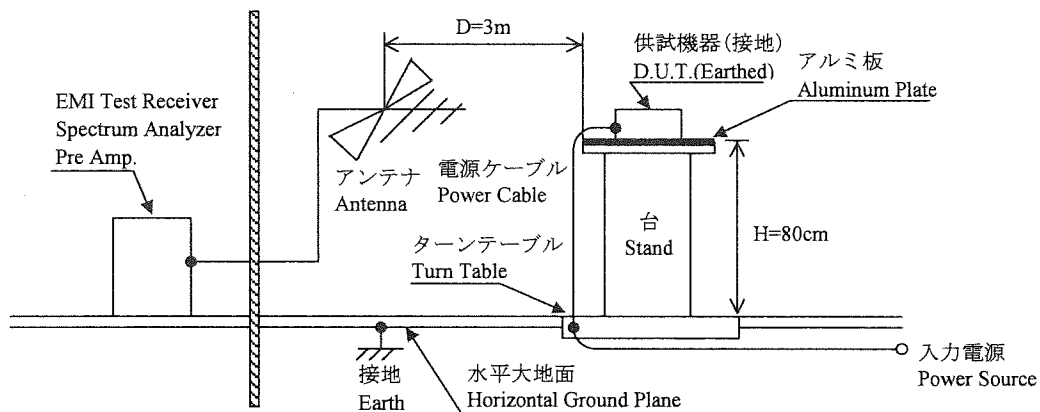

1.2 使用測定機器 List of equipment used

	EQUIPMENT USED	MANUFACTURER	MODEL NO.
1	DIGITAL STORAGE OSCILLOSCOPE	TEKTRONIX	TDS3012
2	DIGITAL STORAGE OSCILLOSCOPE	YOKOGAWA ELECT.	DL9040L
3	DIGITAL MULTIMETER	AGILENT	34970A
4	DIGITAL POWER METER	YOKOGAWA ELECT.	WT210
5	CURRENT PROBE	YOKOGAWA ELECT.	701928 / 701930
6	DYNAMIC DUMMY LOAD	TAKASAGO	FK-600L / FK-1000L
7	DUMMY LOAD	PCN	RHF250 SIRIES
8	SLIDE REGULATOR	MATSUNAGA	S3-24100
9	ISOLATION TRANS	MATSUNAGA	3WTC-50K
10	CVCF	TAKASAGO	AA2000XG
11	CVCF	NF	ES10000S
12	LEAKAGE CURRENT METER	HIOKI	3156
13	DYNAMIC DIP SIMULATOR	TAKAMISAWA	PSA-210
14	CONTROLLED TEMP. CHAMBER	ESPEC	SU-641 / SH-241
15	EMI TEST RECEIVER / SPECTRUM ANALYZER	ROHDE & SCHWARZ	ESCI
16	PRE AMP.	SONOMA	310N
17	AMN	SCHWARZBECK	NNLK8121
18	ANTENNA	SCHWARZBECK	CBL6111D
19	HARMONIC / FLICKER ANALYZER	KIKUSUI	KHA1000
20	SINGLE-PHASE MASTER	NF	4420
21	REFERENCE IMPEDANCE NETWORK 20A	NF	4150
22	MULTI OUTLET UNIT	KIKUSUI	OT01-KHA

1.3 評価負荷条件 Load condition

Output	Load conditions		
	24V	36V	48V
	Io(A)		
100%	10	6.7	5
200%	20	13.4	10

2.1 静特性 Steady state data

(1) 入力・負荷・温度変動／出力起動・低下電圧

Regulation - line and load, Temperature drift / Start up voltage and Drop out voltage

24V

1. Regulation - line and load

Condition Ta : 25 °C

Iout \ Vin	90VAC	100VAC	200VAC	265VAC	line regulation	
0%	24.009V	24.009V	24.010V	24.010V	1mV	0.004%
50%	24.011V	24.009V	24.010V	24.010V	2mV	0.008%
100%	24.013V	24.013V	24.013V	24.014V	1mV	0.004%
load regulation	4mV	4mV	3mV	4mV		
	0.017%	0.017%	0.013%	0.017%		

2. Temperature drift

Conditions Vin : 100 VAC
Iout : 100 %

Ta	-10°C	+25°C	+50°C	temperature stability	
Vout	23.943V	24.013V	24.028V	85mV	0.354%

3. Start up voltage and Drop out voltage

Conditions Ta : 25 °C
Iout : 100 %

Start up voltage (Vin)	71VAC
Drop out voltage (Vin)	39VAC

36V

1. Regulation - line and load

Condition Ta : 25 °C

Iout \ Vin	90VAC	100VAC	200VAC	265VAC	line regulation	
0%	36.004V	36.004V	36.004V	36.004V	0mV	0.000%
50%	36.004V	36.004V	36.004V	36.004V	0mV	0.000%
100%	36.005V	36.005V	36.005V	36.005V	0mV	0.000%
load regulation	1mV	1mV	1mV	1mV		
	0.003%	0.003%	0.003%	0.003%		

2. Temperature drift

Conditions Vin : 100 VAC
Iout : 100 %

Ta	-10°C	+25°C	+50°C	temperature stability	
Vout	35.979V	36.004V	36.037V	58mV	0.161%

3. Start up voltage and Drop out voltage

Conditions Ta : 25 °C
Iout : 100 %

Start up voltage (Vin)	72VAC
Drop out voltage (Vin)	39VAC

48V

1. Regulation - line and load

Condition Ta : 25 °C

Iout \ Vin	90VAC	100VAC	200VAC	265VAC	line regulation	
0%	48.011V	48.011V	48.011V	48.010V	1mV	0.002%
50%	48.011V	48.011V	48.012V	48.012V	1mV	0.002%
100%	48.010V	48.010V	48.010V	48.011V	1mV	0.002%
load regulation	1mV	1mV	2mV	2mV		
	0.002%	0.002%	0.004%	0.004%		

2. Temperature drift

Conditions Vin : 100 VAC
Iout : 100 %

Ta	-10°C	+25°C	+50°C	temperature stability	
Vout	47.954V	48.011V	48.027V	73mV	0.152%

3. Start up voltage and Drop out voltage

Conditions Ta : 25 °C
Iout : 100 %

Start up voltage (Vin)	72VAC
Drop out voltage (Vin)	41VAC

(2) 効率が出力電流

Efficiency vs. Output current

Conditions Vin : 90 VAC -----
 : 100 VAC - - - - -
 : 200 VAC ————
 : 265 VAC - - - - -
 Ta : 25 °C

24V

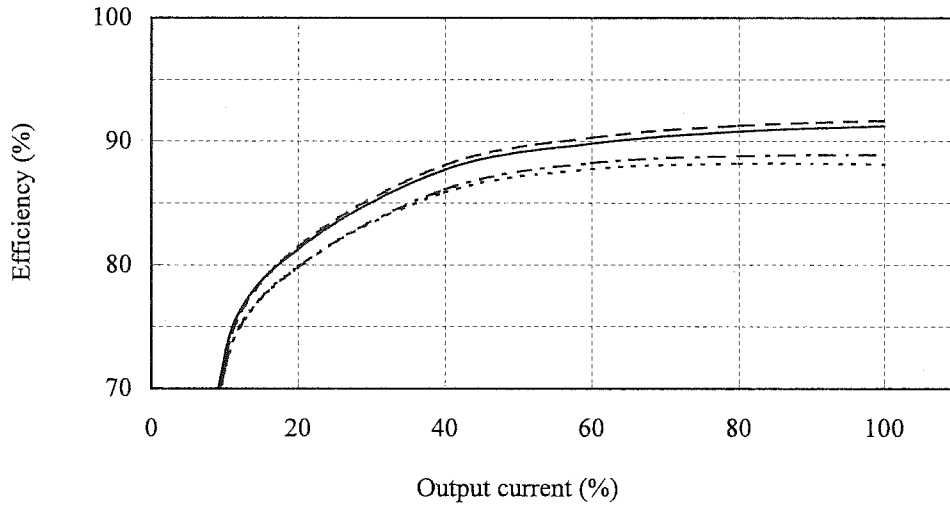

36V

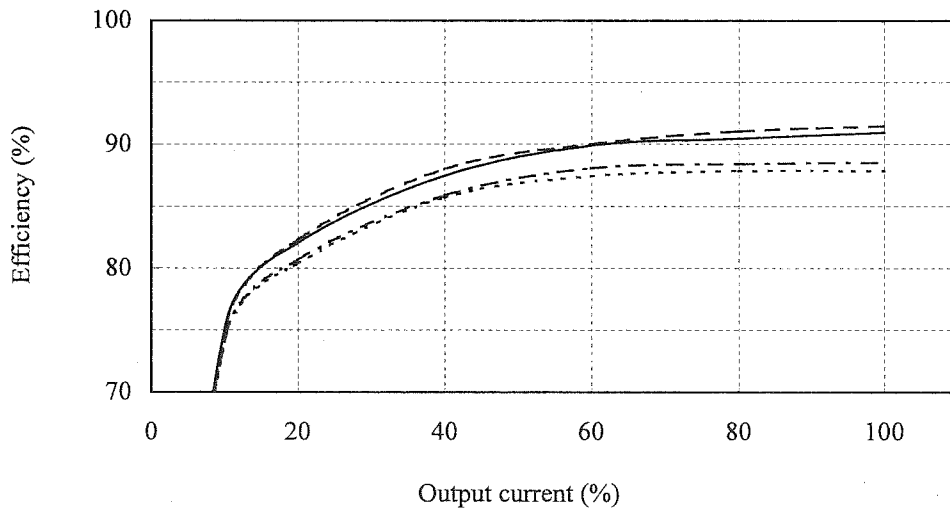

48V

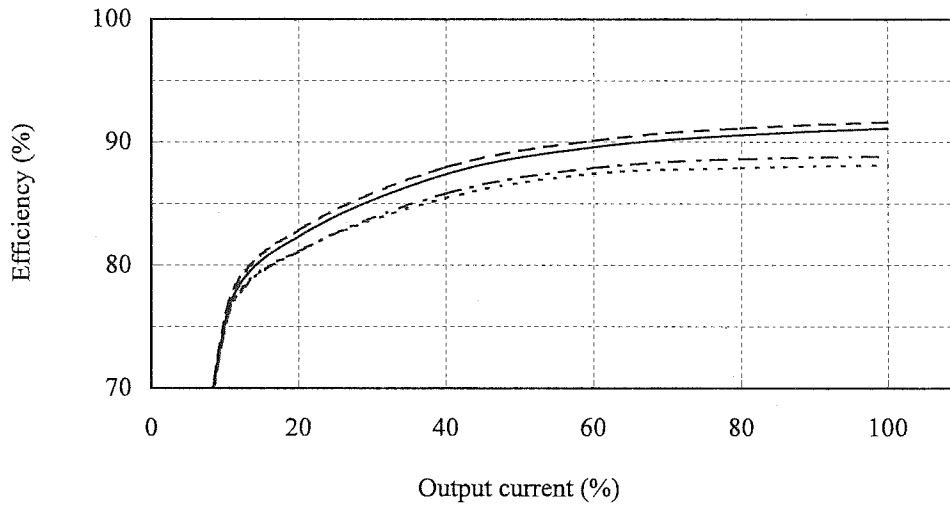

ZWS240BP

(3) 入力電流対出力電流

Input current vs. Output current

Conditions Vin : 90 VAC -----
 : 100 VAC - - - -
 : 200 VAC ————
 : 265 VAC - - - -
 Ta : 25 °C

24V

Vin	Input current	
	Iout : 0%	Control OFF*
90VAC	0.04A	0.02A
100VAC	0.04A	0.02A
200VAC	0.05A	0.05A
265VAC	0.06A	0.06A

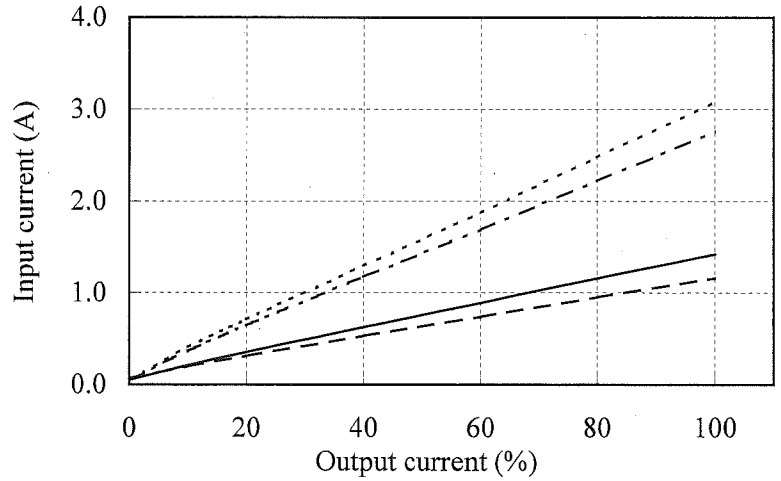

36V

Vin	Input current	
	Iout : 0%	Control OFF*
90VAC	0.04A	0.02A
100VAC	0.05A	0.02A
200VAC	0.05A	0.05A
265VAC	0.06A	0.06A

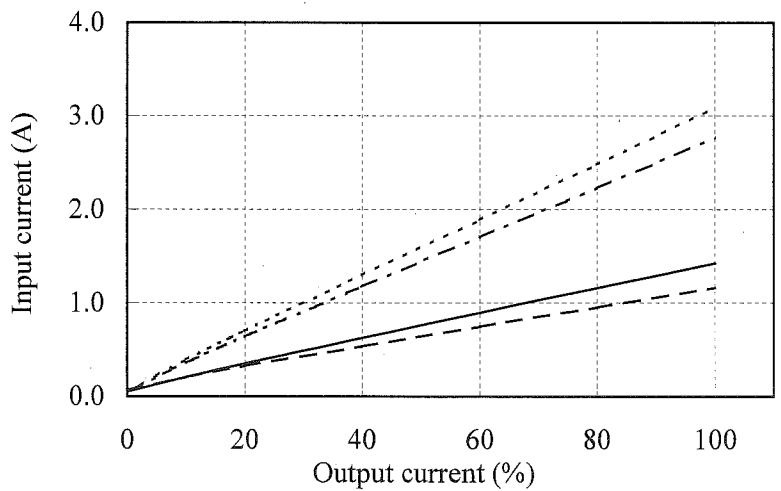

48V

Vin	Input current	
	Iout : 0%	Control OFF*
90VAC	0.04A	0.02A
100VAC	0.04A	0.02A
200VAC	0.05A	0.05A
265VAC	0.06A	0.06A

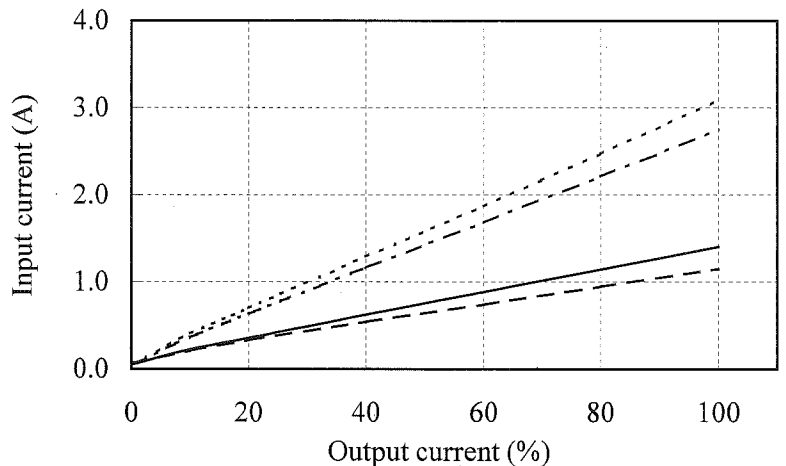

* 準標準品 ZWS240BP-*/R にて対応
 For option model ZWS240BP-*/R

(4) 入力電力対出力電流

Input power vs. Output current

Conditions Vin : 90 VAC -----
 : 100 VAC - - - - -
 : 200 VAC ————
 : 265 VAC - - - - -
 Ta : 25 °C

24V

Vin	Input power	
	Iout : 0%	Control OFF*
90VAC	2.1W	0.1W
100VAC	2.1W	0.1W
200VAC	2.2W	0.5W
265VAC	2.6W	0.8W

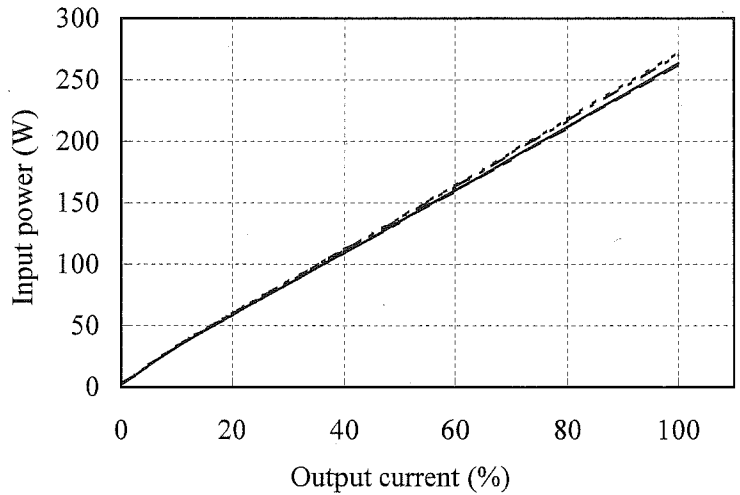

36V

Vin	Input power	
	Iout : 0%	Control OFF*
90VAC	2.0W	0.1W
100VAC	2.0W	0.1W
200VAC	2.0W	0.5W
265VAC	2.6W	0.8W

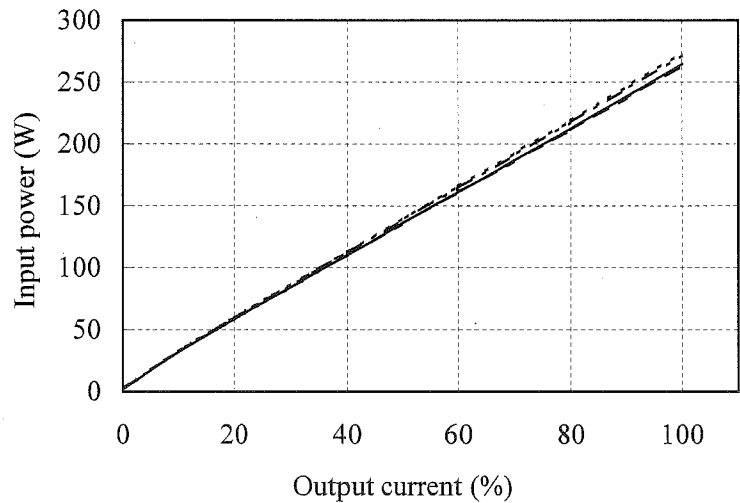

48V

Vin	Input power	
	Iout : 0%	Control OFF*
90VAC	2.1W	0.1W
100VAC	2.1W	0.1W
200VAC	2.2W	0.5W
265VAC	2.5W	0.8W

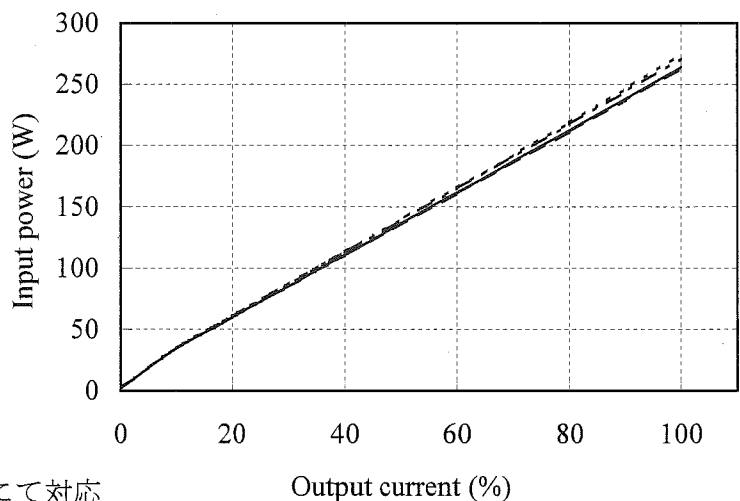

* 準標準品 ZWS240BP-*/R にて対応
 For option model ZWS240BP-*/R

2.2 過電流保護特性

Over current protection (OCP) characteristics

2.3 過電圧保護特性

Over voltage protection (OVP) characteristics

Conditions Vin : 100 VAC
 Ta : -10 °C -----
 25 °C - - - - -
 50 °C _____

Conditions Vin : 100 VAC
 Iout : 0 %
 Ta : 25 °C

24V

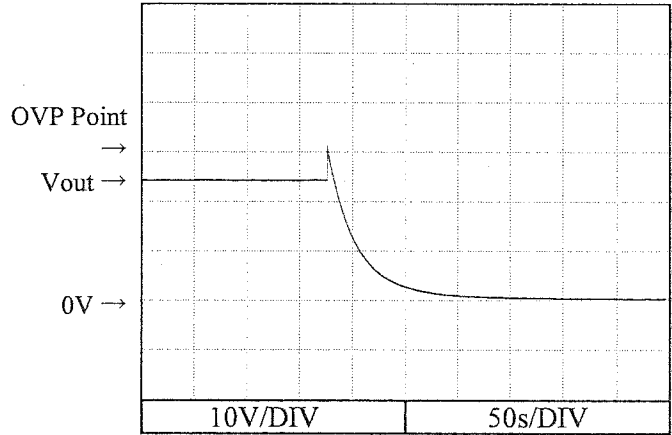
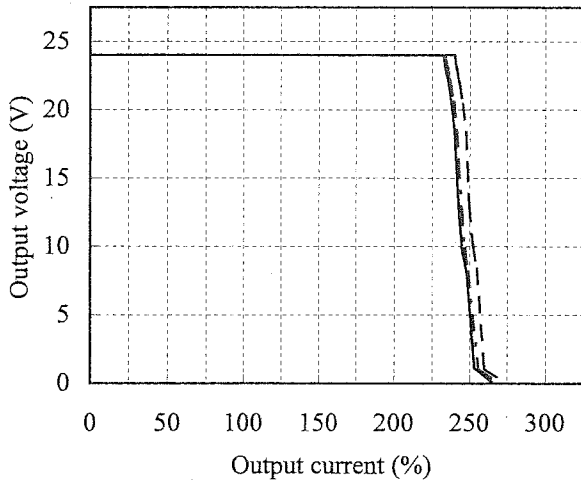

36V

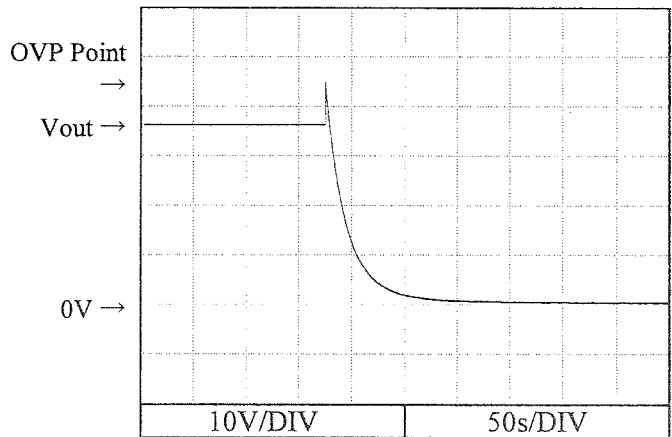
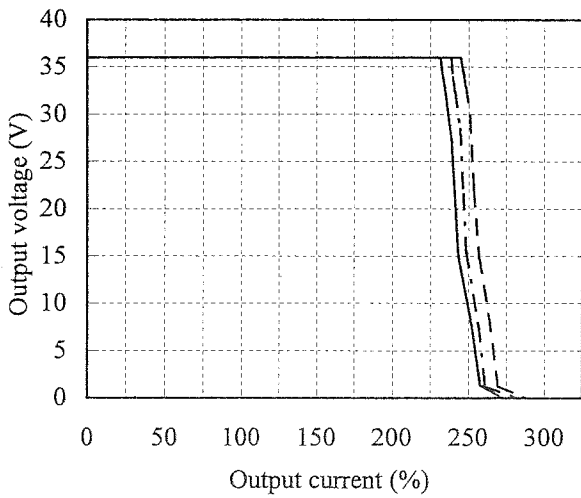

48V

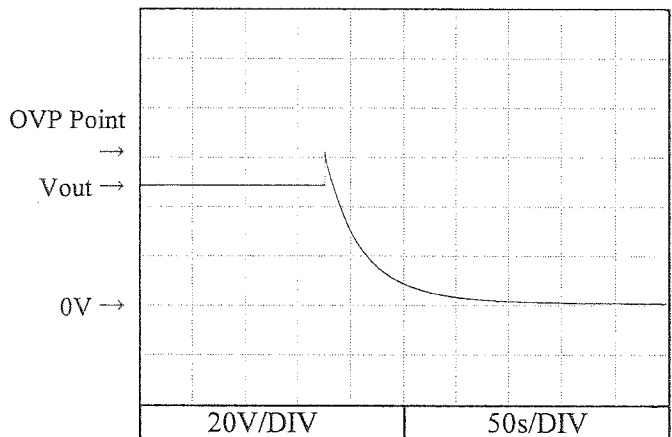
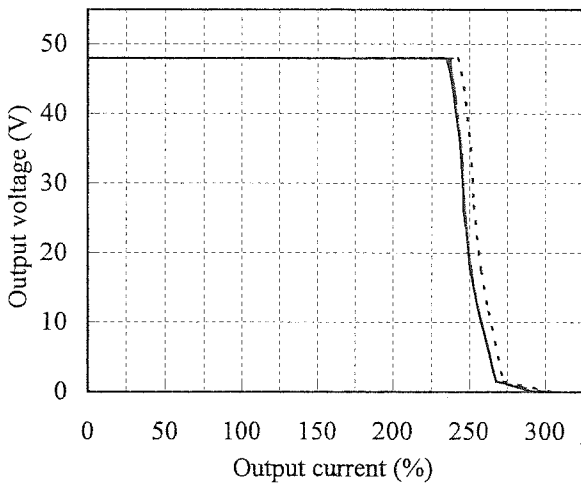

2.4 出力立ち上がり特性

Output rise characteristics

Conditions Vin : 90 VAC (A)
 100 VAC (B)
 200 VAC (C)
 265 VAC (D)
 Ta : 25 °C

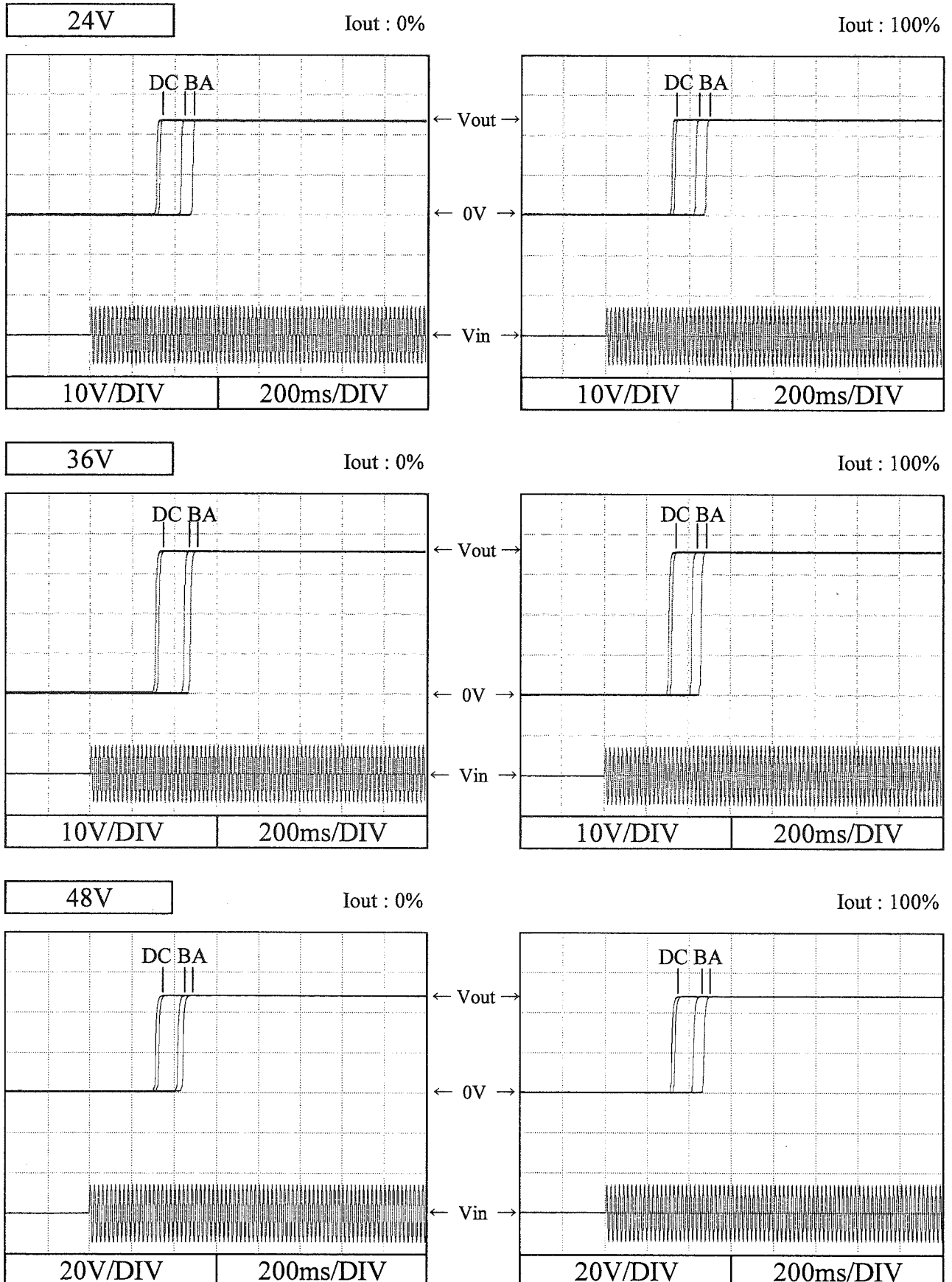

2.4 出力立ち上がり特性 Output rise characteristics

Conditions Vin : 90 VAC (A)
 100 VAC (B)
 200 VAC (C)
 265 VAC (D)
 Ta : 25 °C

24V

Iout : 200%

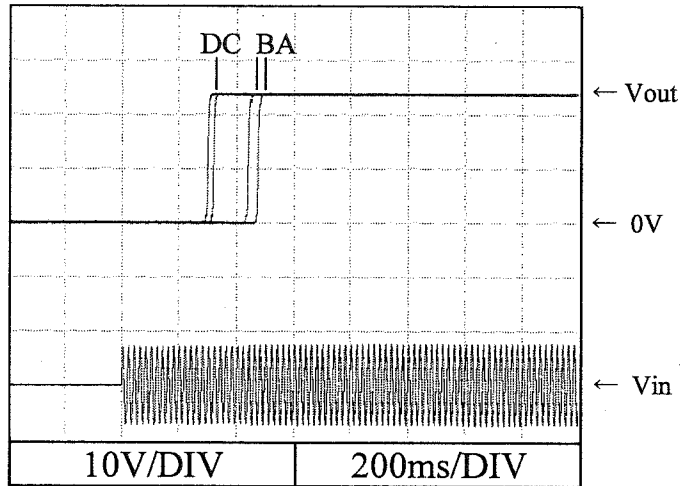

36V

Iout : 200%

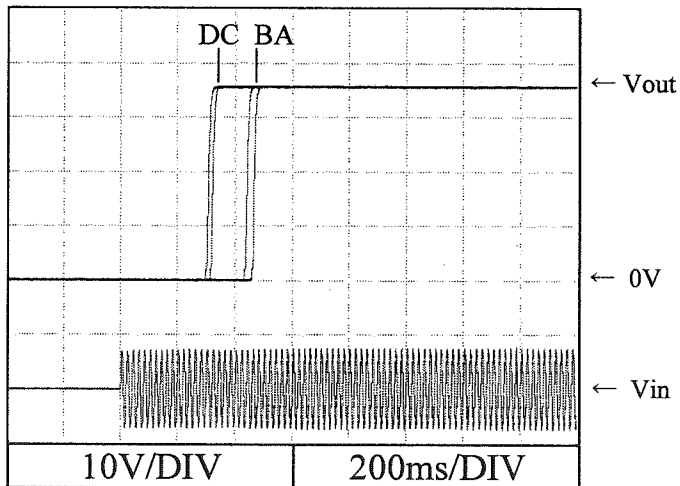

48V

Iout : 200%

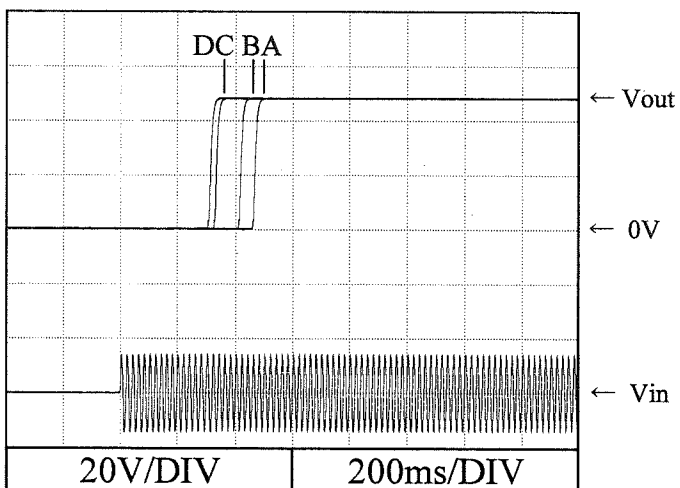

2.5 出力立ち下がり特性

Output fall characteristics

Conditions Vin : 90 VAC (A)
 100 VAC (B)
 200 VAC (C)
 265 VAC (D)
 Ta : 25 °C

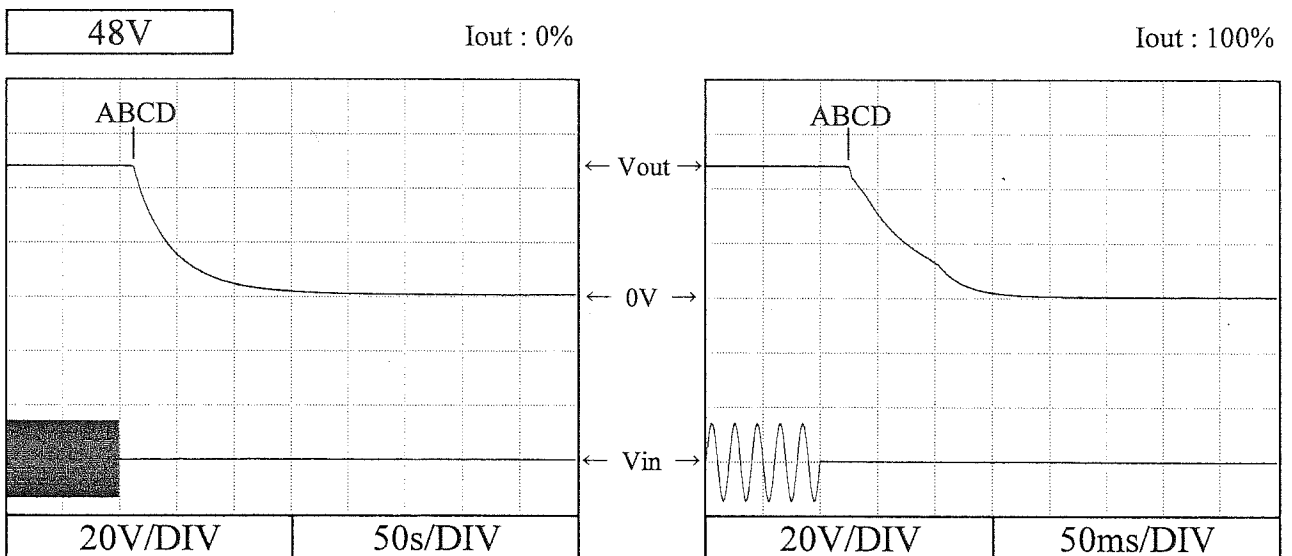
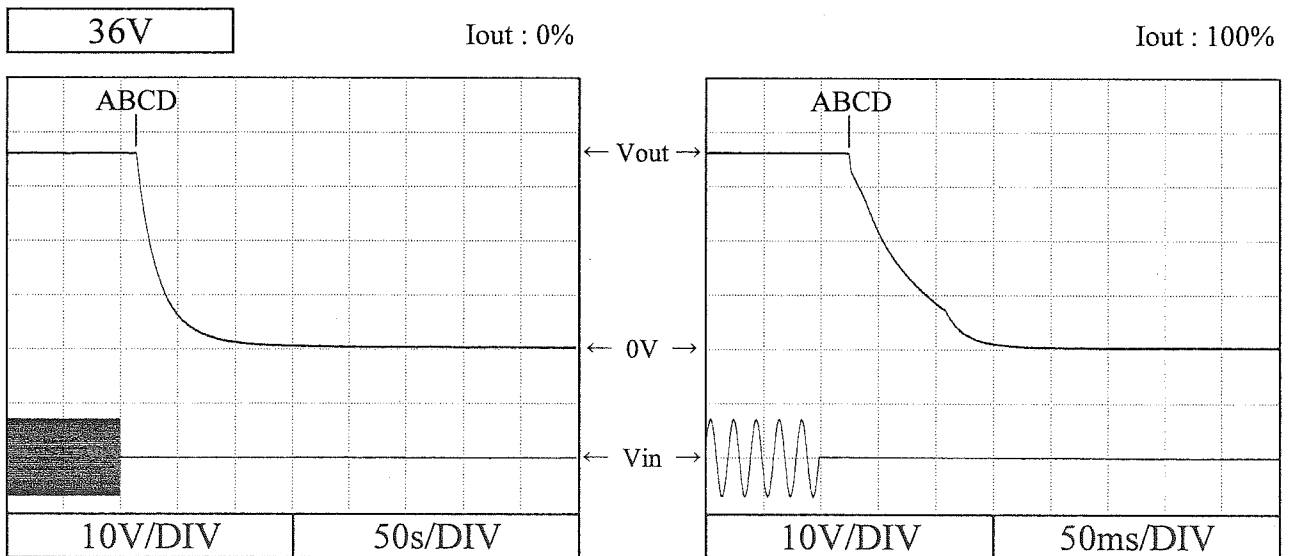
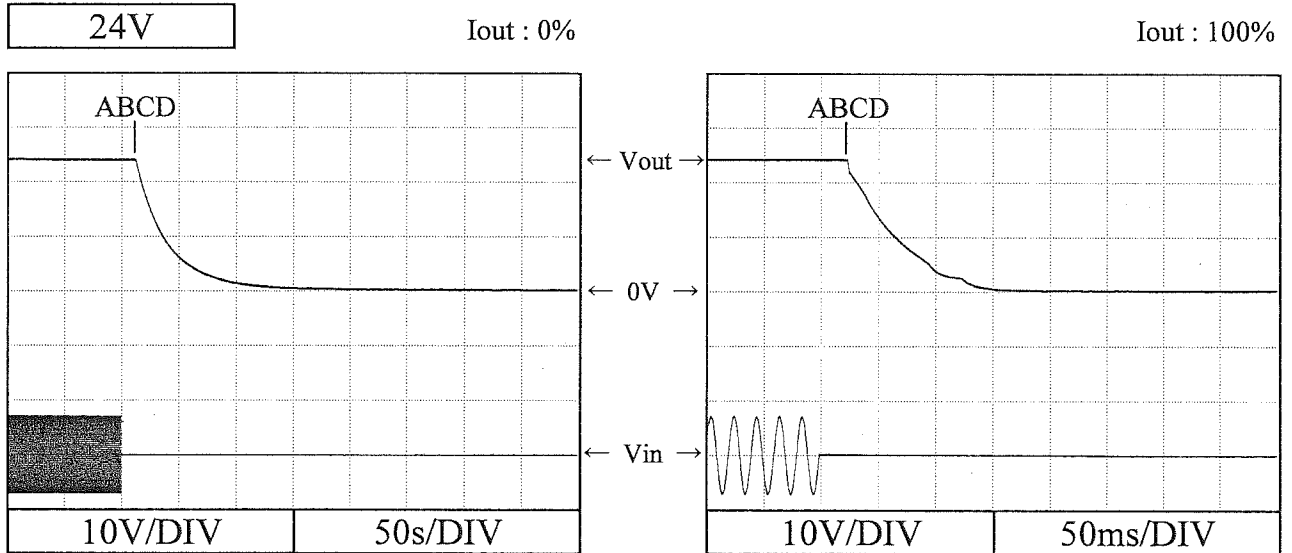

2.6 ON/OFFコントロール時出力立ち上がり、立ち下がり特性

Output rise, fall characteristics with ON/OFF Control

Conditions V_{in} : 100 VAC

I_{out} : 100 %

T_a : 25 °C

準標準品 ZWS240BP-*/R にて対応

For option model ZWS240BP-*/R

24V

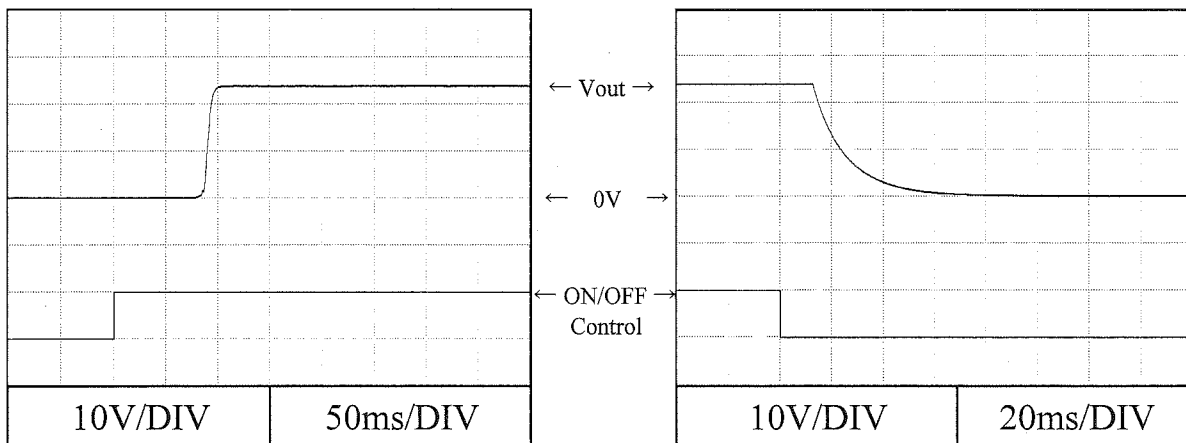

36V

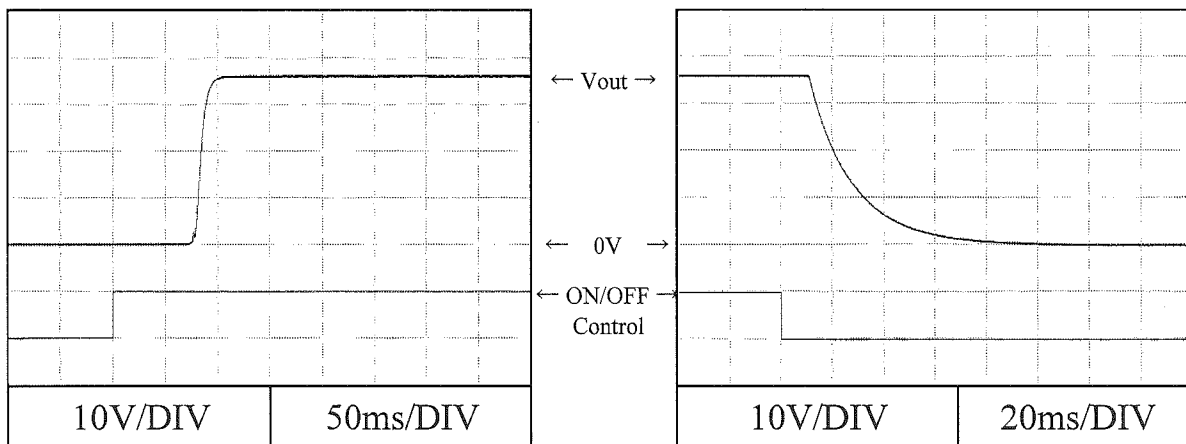

48V

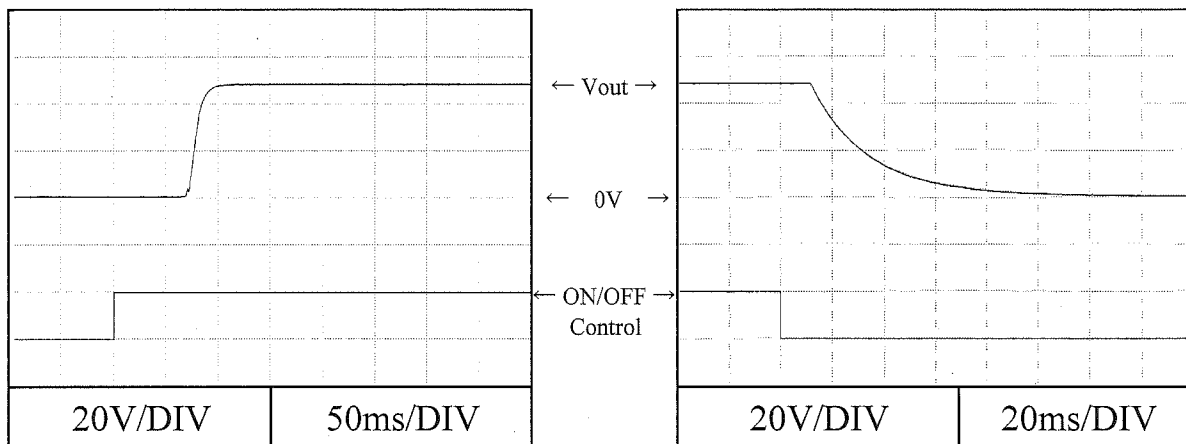

2.7 出力保持時間特性

Hold up time characteristics

Conditions V_{in} : 100 VAC -----
 200 VAC ————
 T_a : 25 °C

24V

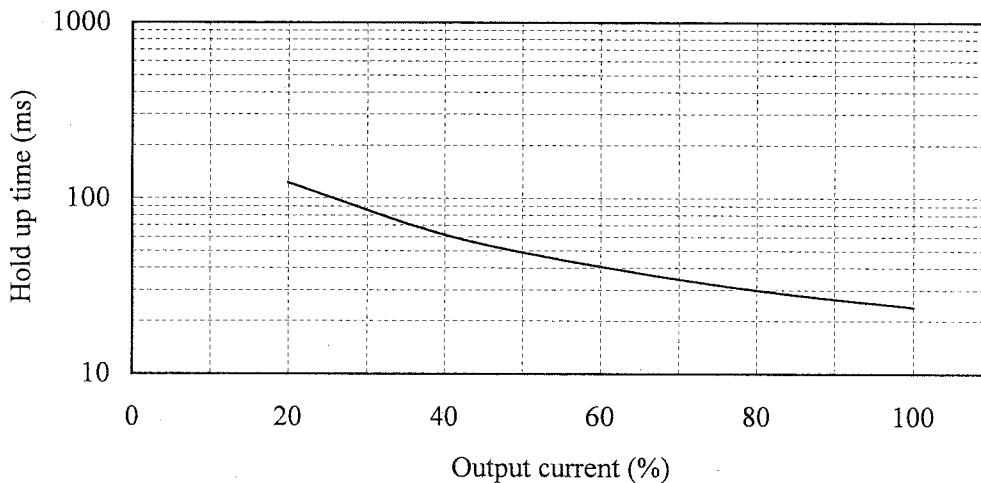

36V

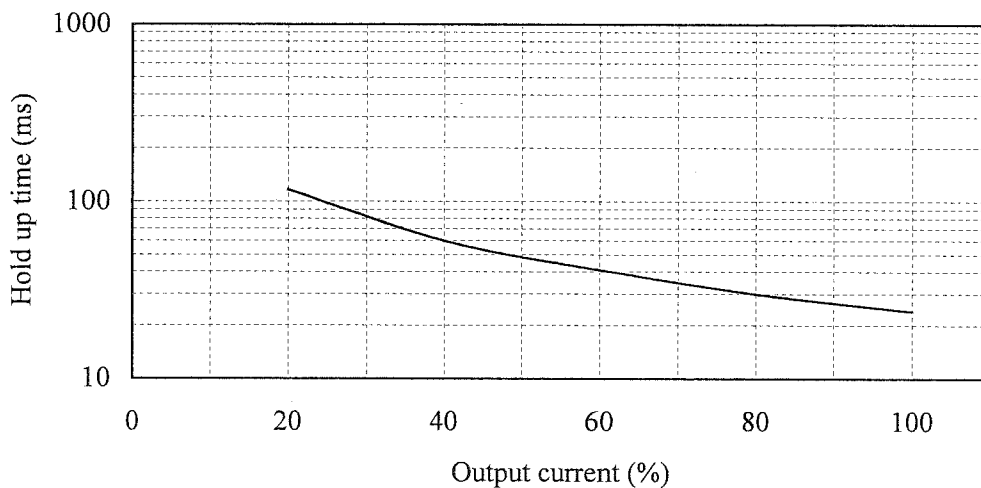

48V

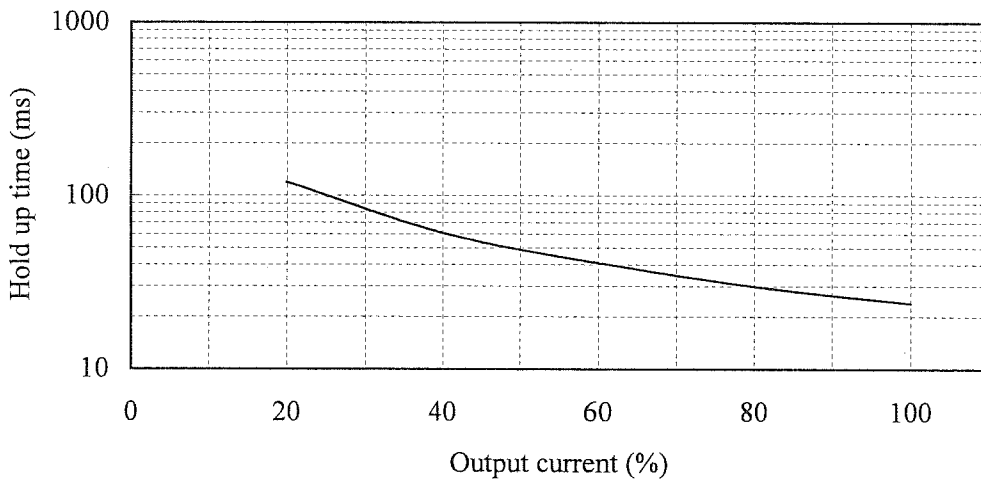

2.8 過渡応答（負荷急変）特性

Dynamic load response characteristics

Conditions V_{in} : 100 VAC
 I_{out} : 50 % \leftrightarrow 100 %
 (tr = tf = 50us)
 T_a : 25 °C

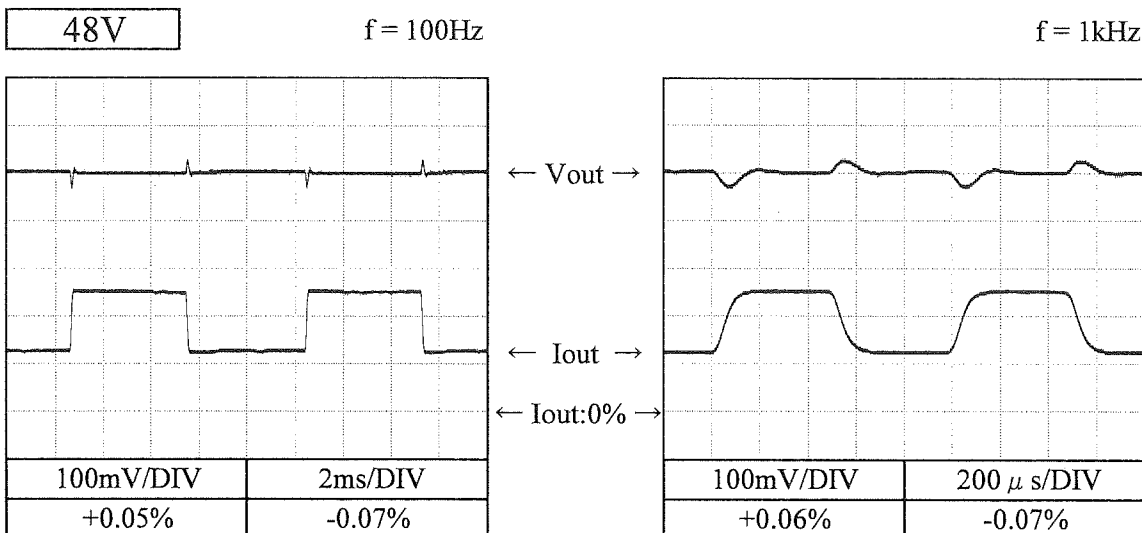
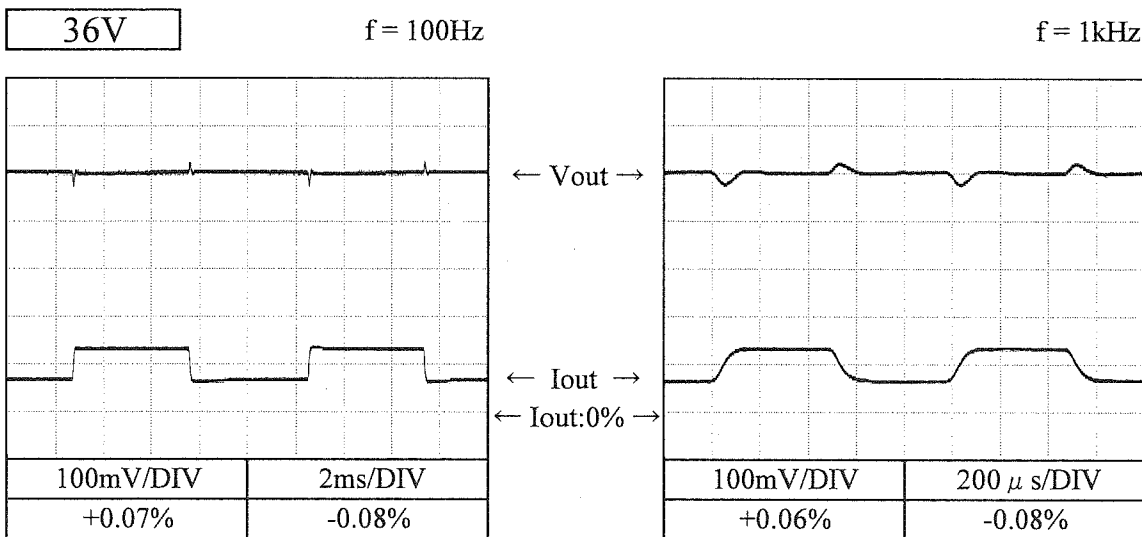
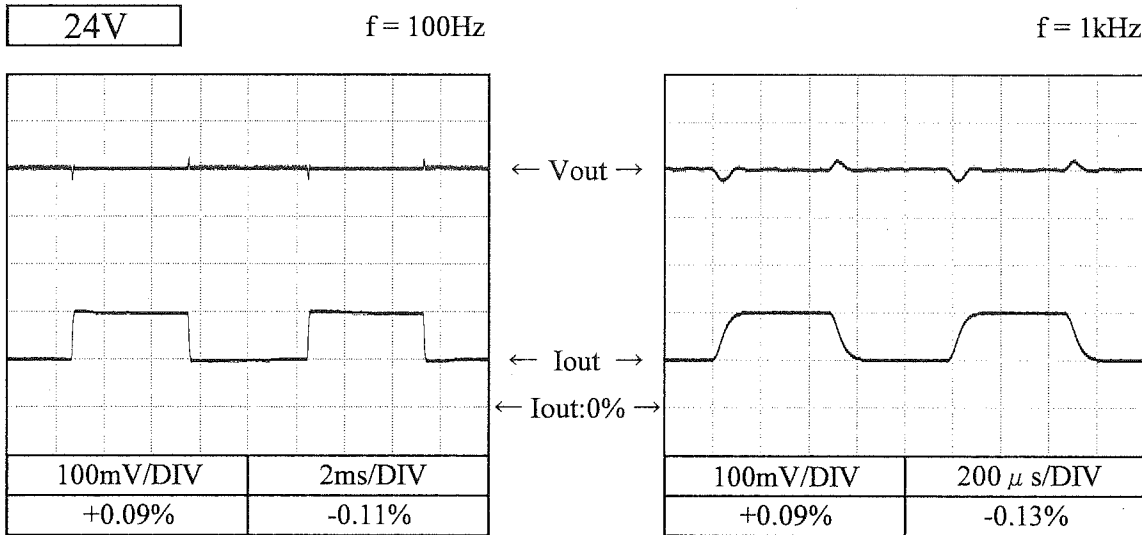

2.8 過渡応答（負荷急変）特性

Dynamic load response characteristics

Conditions Vin : 100 VAC
 Iout : 0 % ↔ 200 %
 (tr = tf = 50us)
 Ta : 25 °C

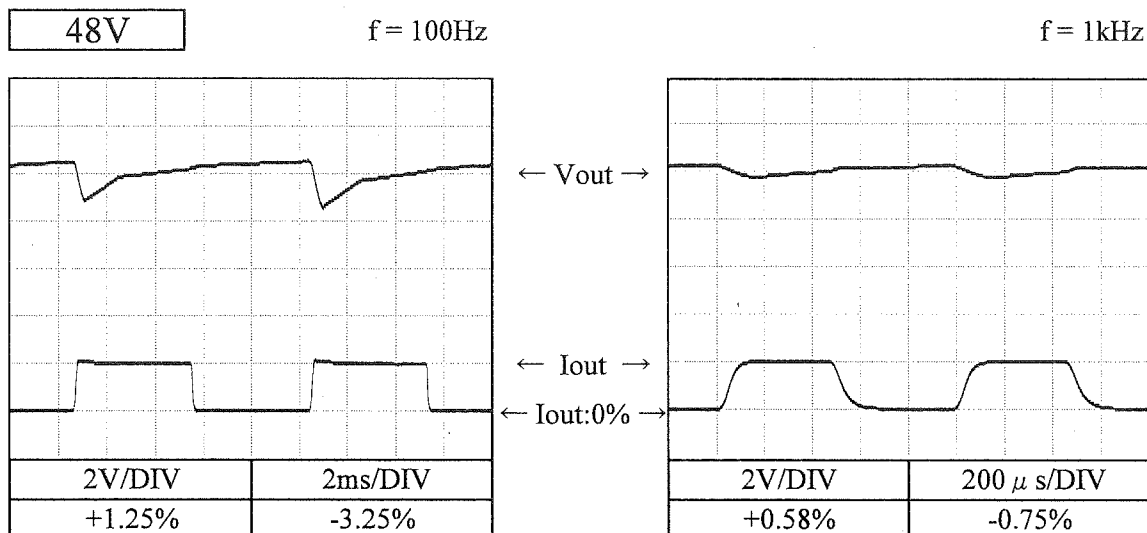
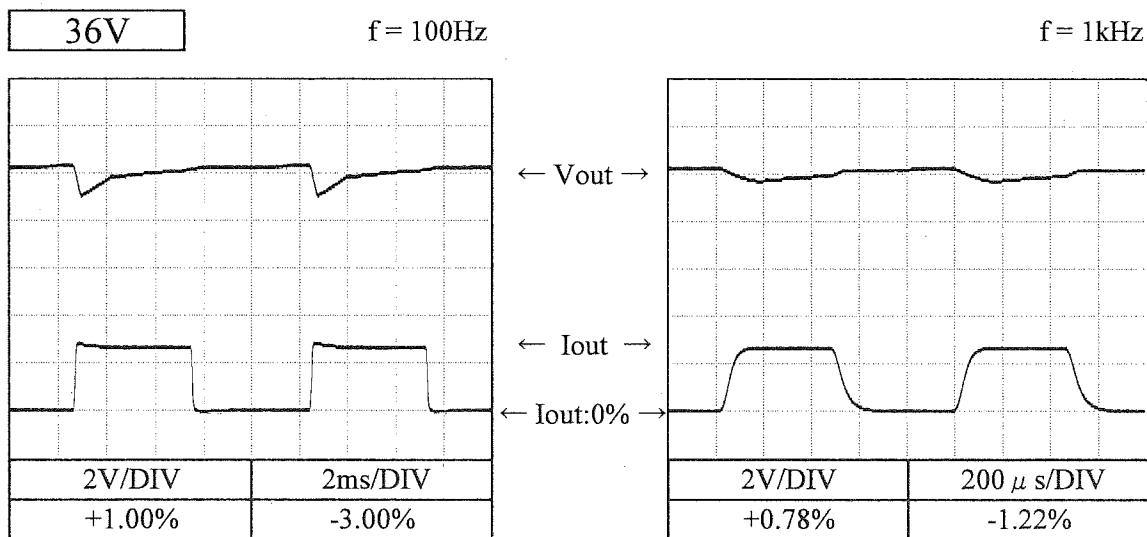
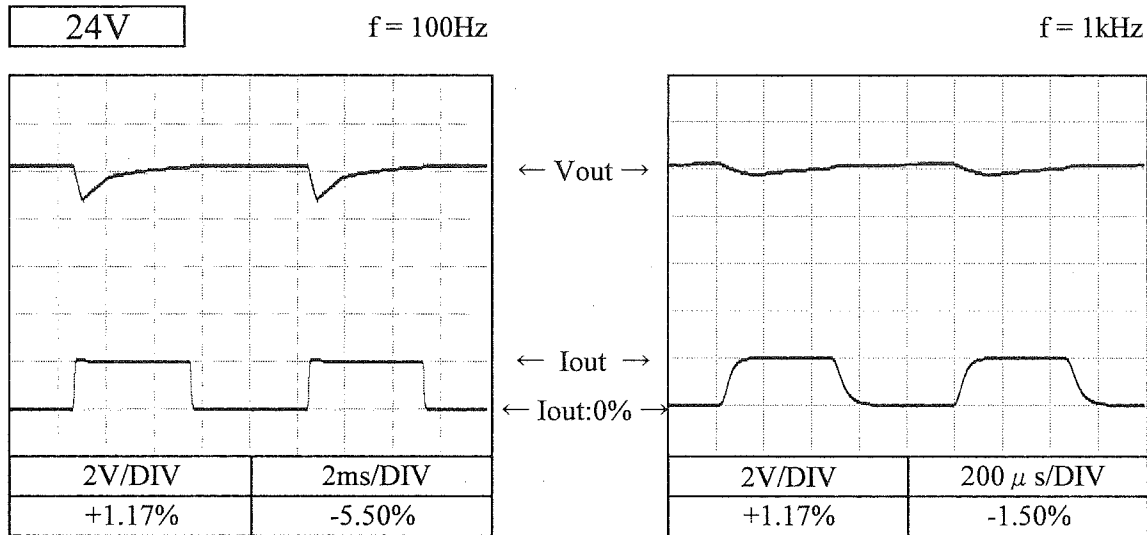

2.9 入力電圧瞬停特性

Response to brown out characteristics

Conditions V_{in} : 100 VAC

I_{out} : 100 %

T_a : 25 °C

24V

A = 23ms

B = 46ms

C = 47ms

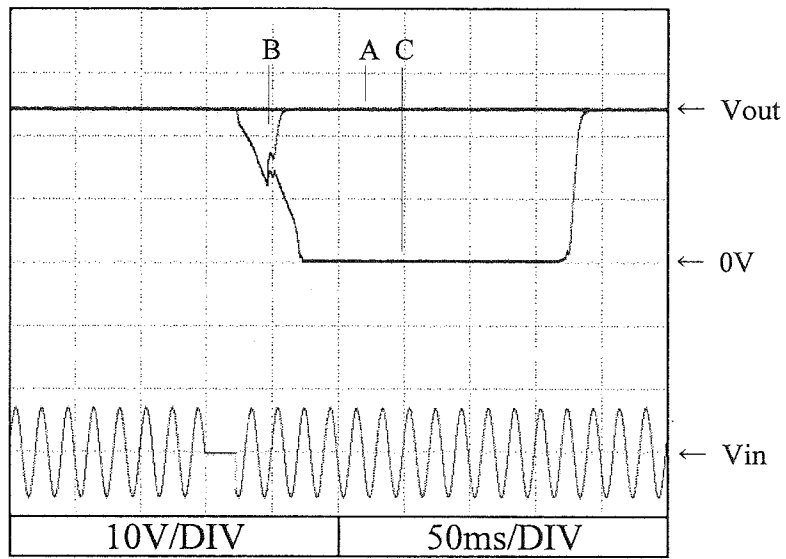

36V

A = 24ms

B = 47ms

C = 48ms

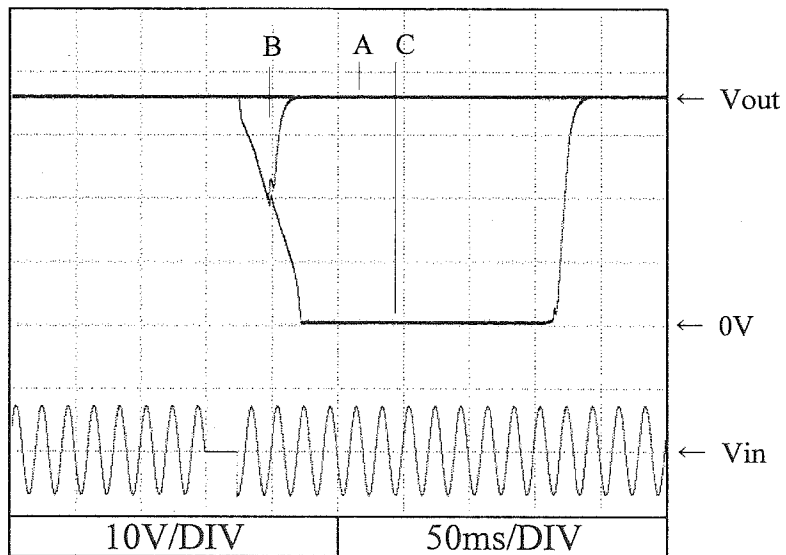

48V

A = 25ms

B = 47ms

C = 48ms

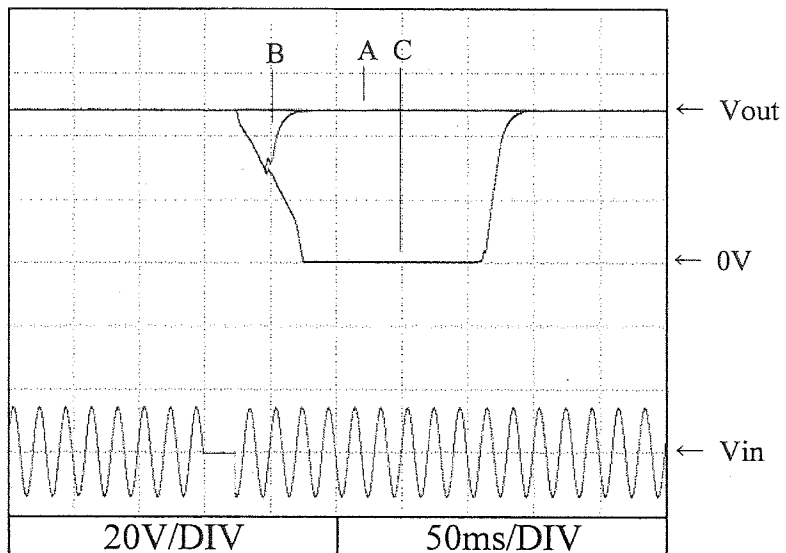

2.9 入力電圧瞬停特性

Response to brown out characteristics

Conditions Vin : 200 VAC

Iout : 100 %

Ta : 25 °C

24V

A = 23ms

B = 64ms

C = 65ms

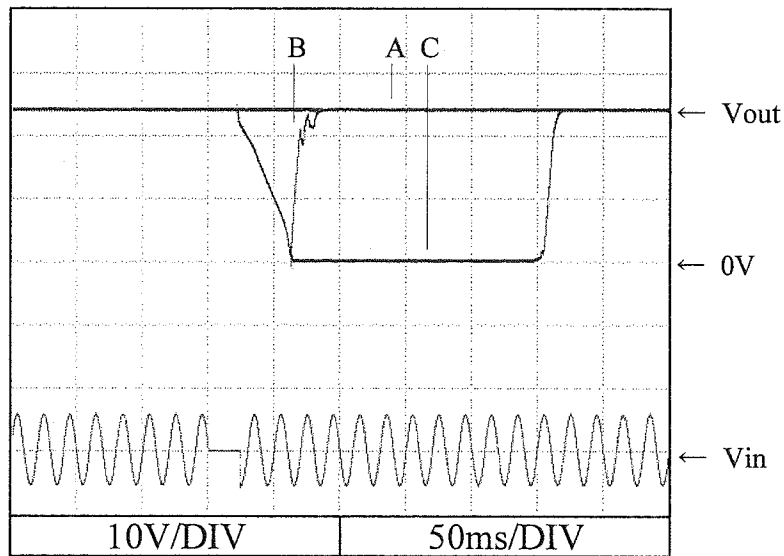

36V

A = 24ms

B = 65ms

C = 66ms

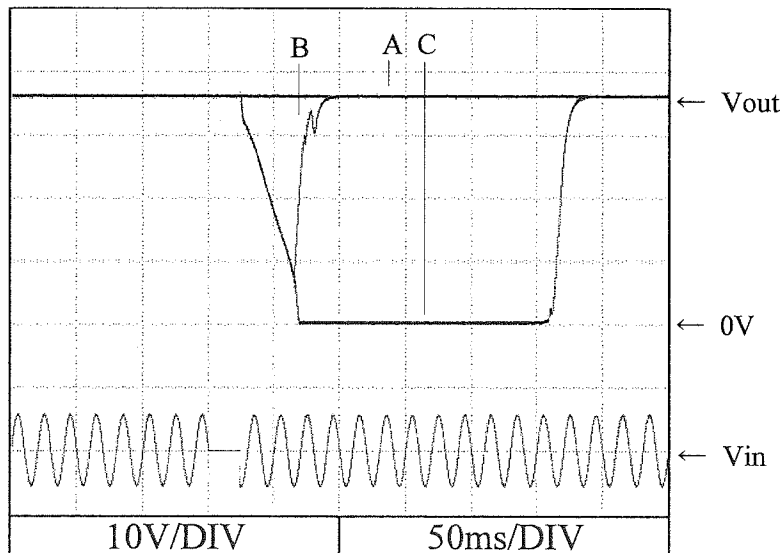

48V

A = 25ms

B = 67ms

C = 68ms

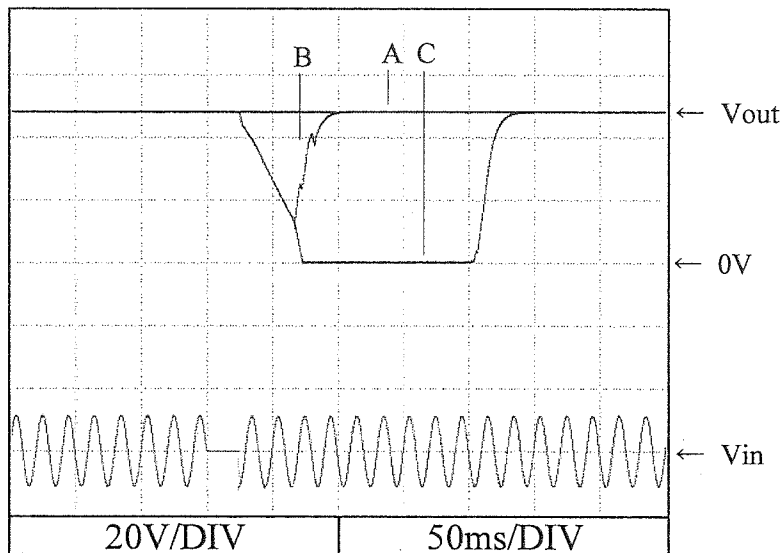

2.10 入力サージ電流 (突入電流) 波形
Inrush current waveform

24V

Conditions V_{in} : 100 VAC
 I_{out} : 100 %
 T_a : 25 °C

Switch on phase angle of input AC voltage
 $\phi = 0^\circ$

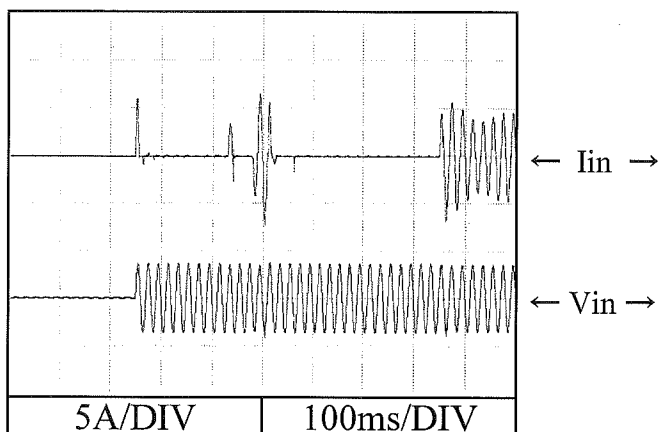

Switch on phase angle of input AC voltage
 $\phi = 90^\circ$

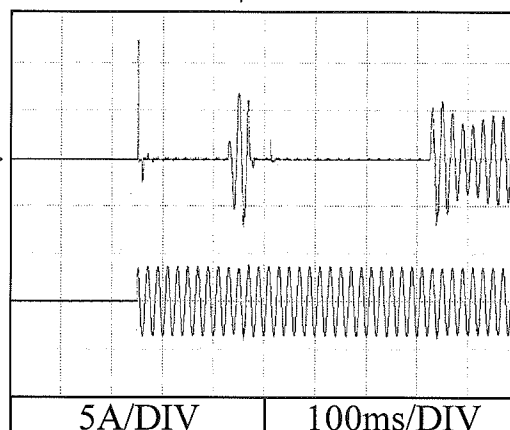

Conditions V_{in} : 200 VAC
 I_{out} : 100 %
 T_a : 25 °C

Switch on phase angle of input AC voltage
 $\phi = 0^\circ$

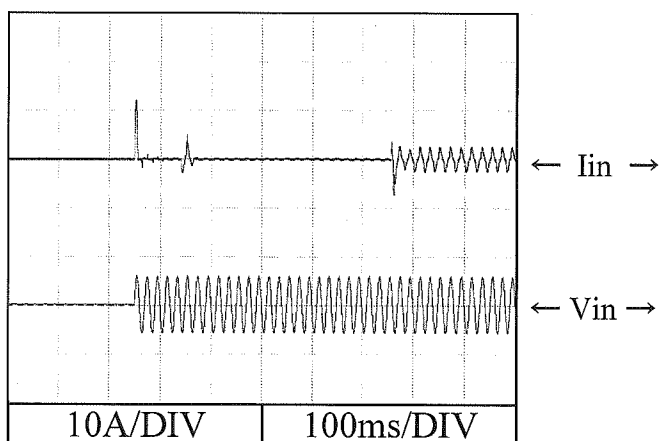

Switch on phase angle of input AC voltage
 $\phi = 90^\circ$

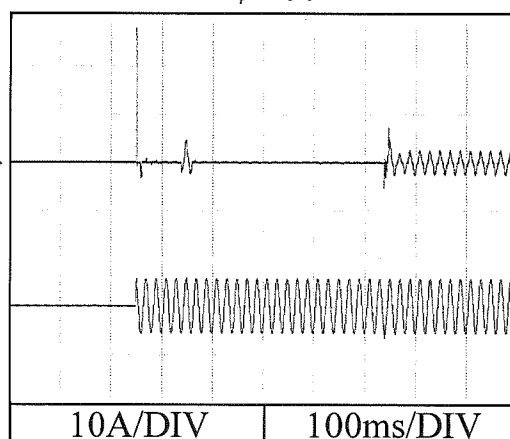

2.11 高調波成分

Input current harmonics

Conditions Iout : 100 %

Ta : 25 °C

24V

Vin : 100 VAC

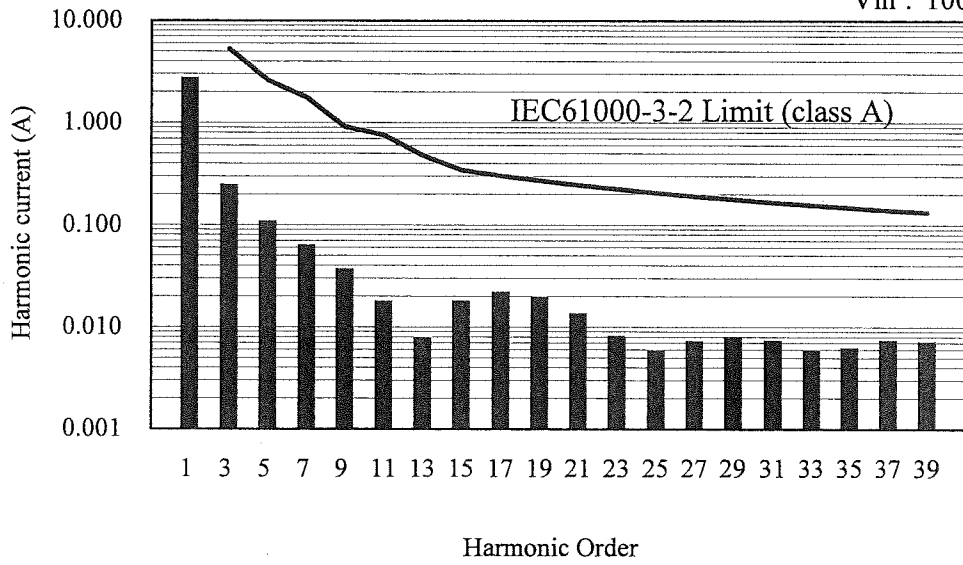

Vin : 230 VAC

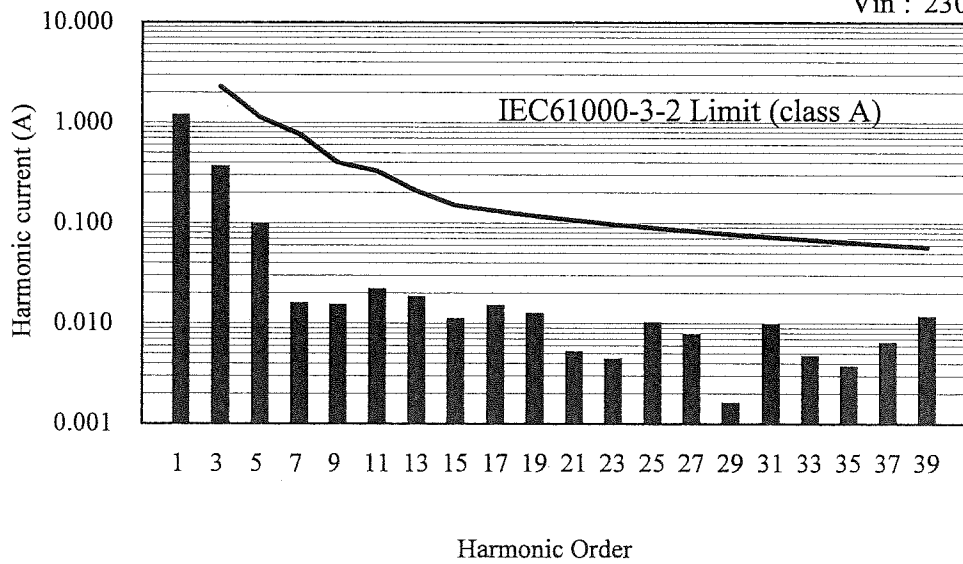

2.12 入力電流波形

Input current waveform

Conditions Iout : 100 %

Ta : 25 °C

24V

Vin : 100VAC

Vin : 230VAC

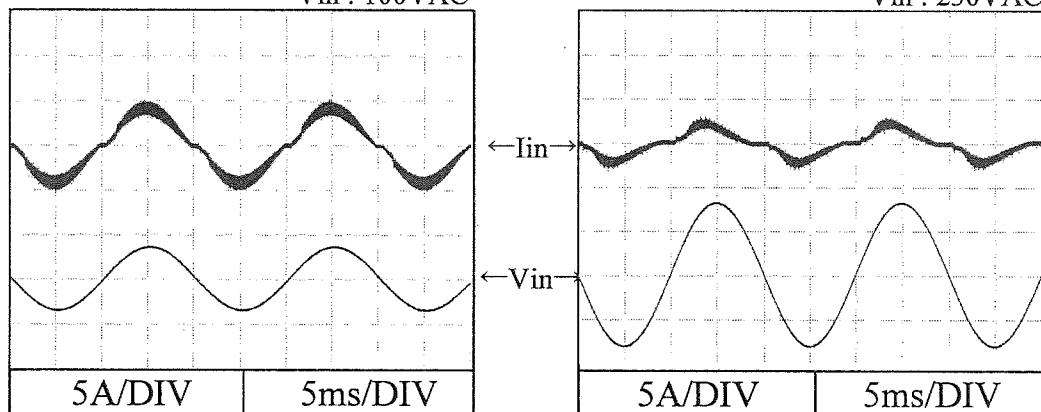

2.13 リーク電流特性 Leakage current characteristics

Conditions Iout : 0 % -----
 100 % ————
 Ta : 25 °C
Equipment used : 3156 (HIOKI)

24V

f : 50 Hz

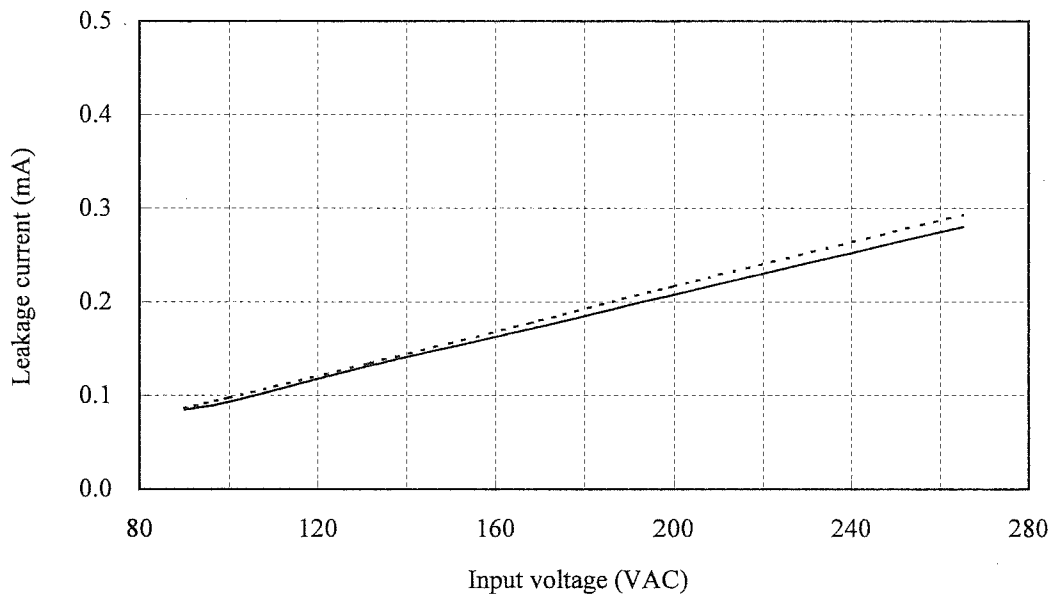

f : 60 Hz

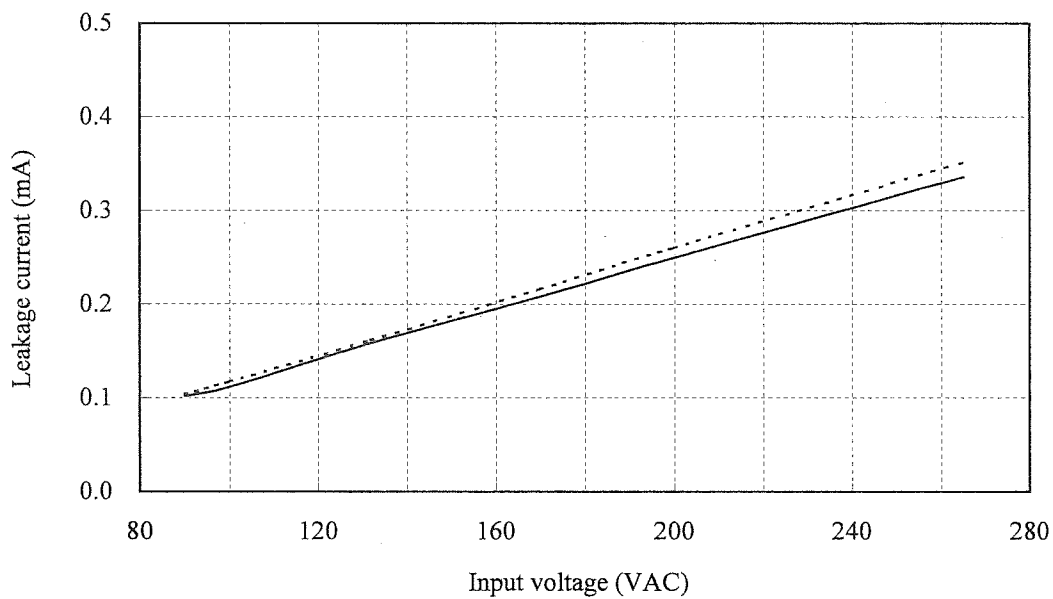

2.14 出力リップル、ノイズ波形
Output ripple and noise waveform

Conditions Vin : 100 VAC
Ta : 25 °C

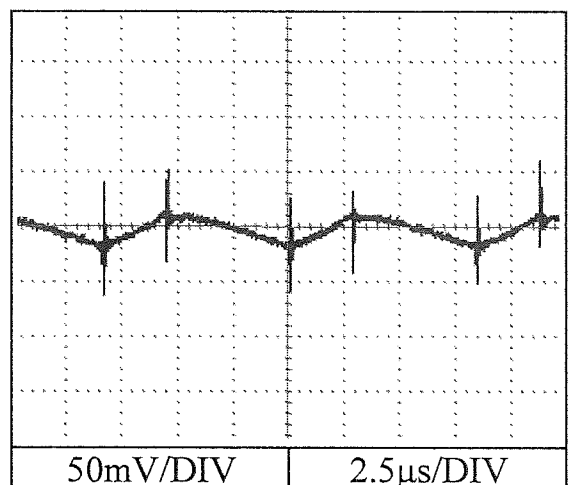
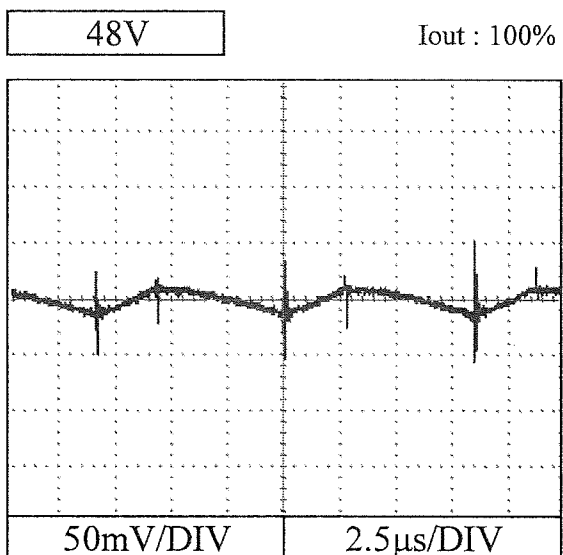
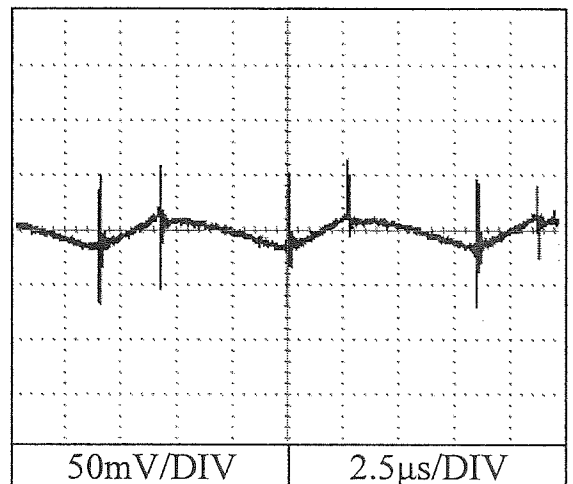
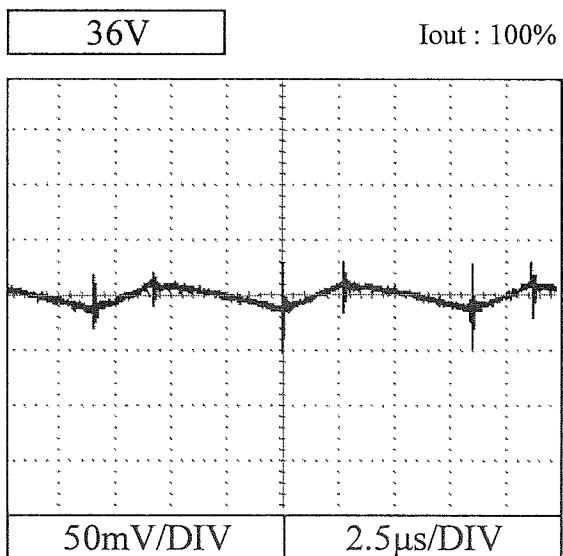
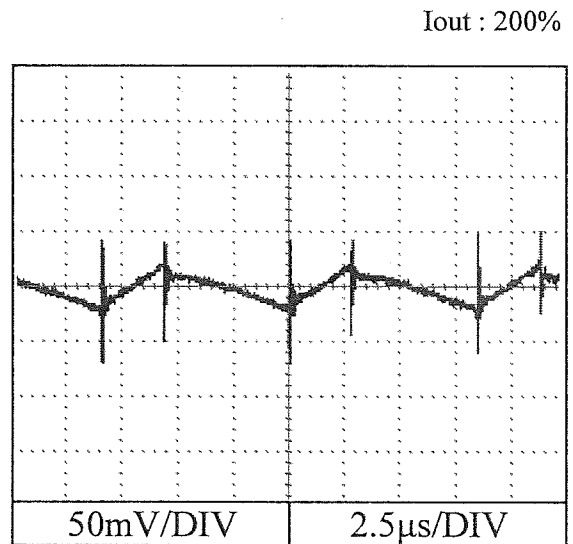
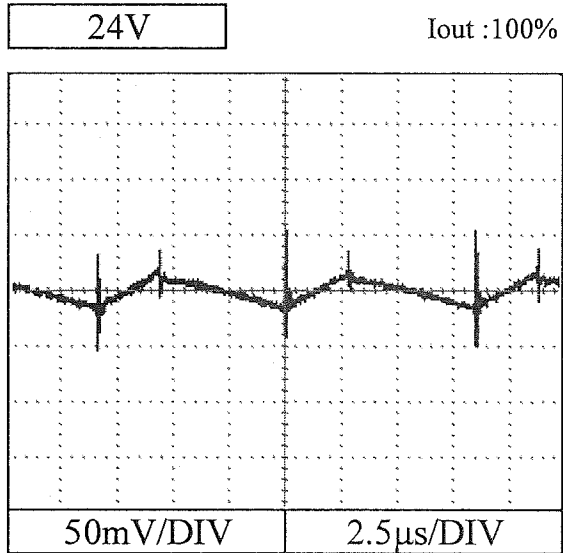

2.15 EMI 特性

Electro-Magnetic Interference characteristics

Conditions Vin : 230 VAC

Iout : 100 %

Ta : 25 °C

雑音端子電圧

Conducted Emission

24V

Phase : N

Point A (189kHz)		
Ref. Data	Limit (dBuV)	Measure (dBuV)
QP	64.1	50.6
AV	54.1	47.0

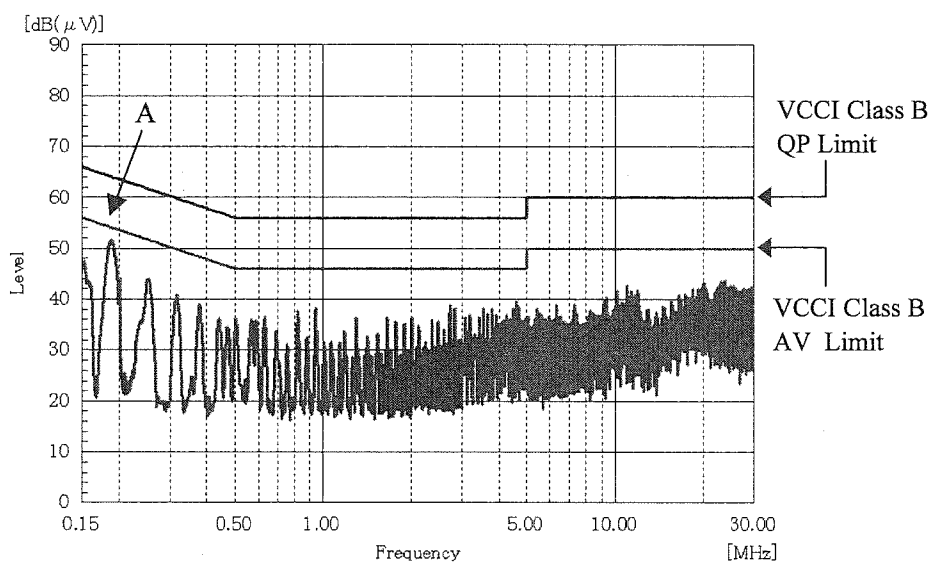

Phase : L

Point B (190kHz)		
Ref. Data	Limit (dBuV)	Measure (dBuV)
QP	64.0	50.1
AV	54.0	46.4

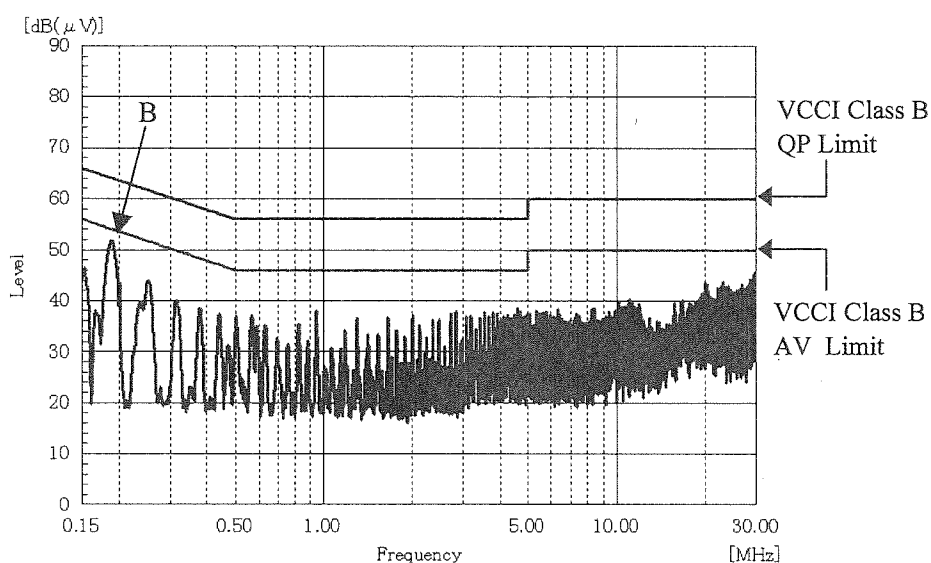

EN55011-B,EN55022-B,FCC-Bの限界値はVCCI class Bの限界値と同じ
Limit of EN55011-B,EN55022-B,FCC-B are same as its VCCI class B.

2.15 EMI 特性

Electro-Magnetic Interference characteristics

Conditions Vin : 230 VAC

Iout : 100 %

Ta : 25 °C

雑音端子電圧

Conducted Emission

36V

Phase : N

Point A (188kHz)		
Ref. Data	Limit (dBuV)	Measure (dBuV)
QP	64.1	48.5
AV	54.1	44.3

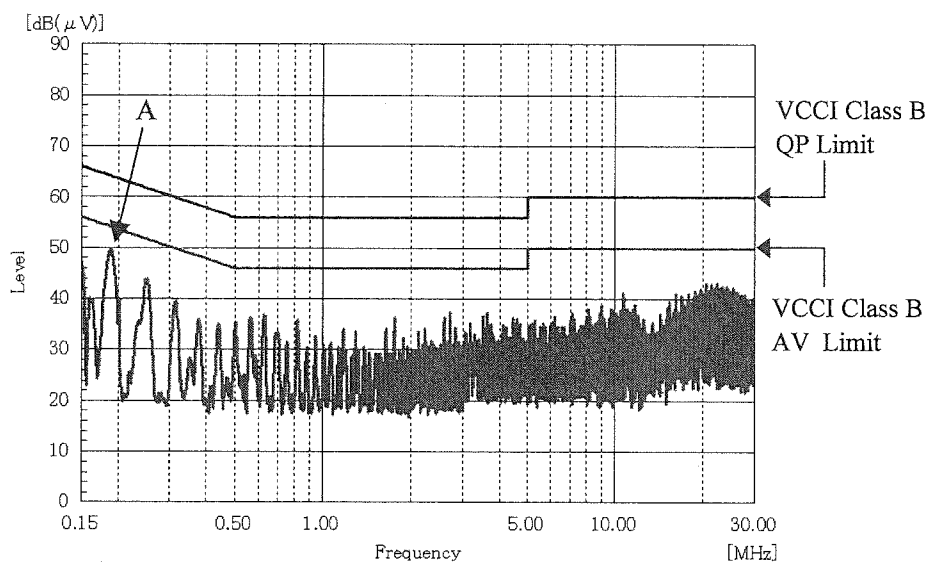

Phase : L

Point B (188kHz)		
Ref. Data	Limit (dBuV)	Measure (dBuV)
QP	64.1	48.0
AV	54.1	44.0

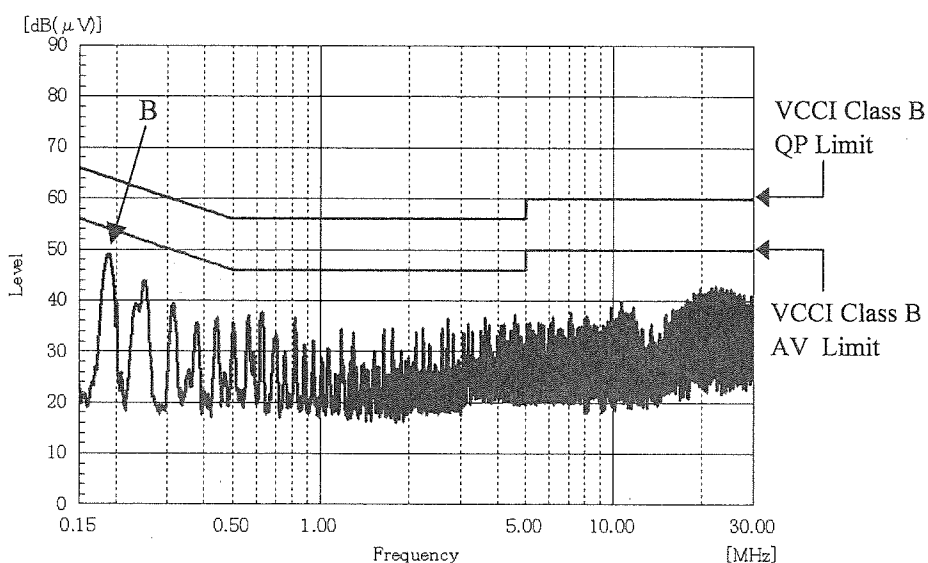

EN55011-B,EN55022-B,FCC-Bの限界値はVCCI class Bの限界値と同じ
Limit of EN55011-B,EN55022-B,FCC-B are same as its VCCI class B.

2.15 EMI 特性

Electro-Magnetic Interference characteristics

Conditions Vin : 230 VAC
Iout : 100 %
Ta : 25 °C

雑音端子電圧

Conducted Emission

48V

Phase : N

Point A (195kHz)		
Ref. Data	Limit (dBuV)	Measure (dBuV)
QP	63.8	49.5
AV	53.8	45.7

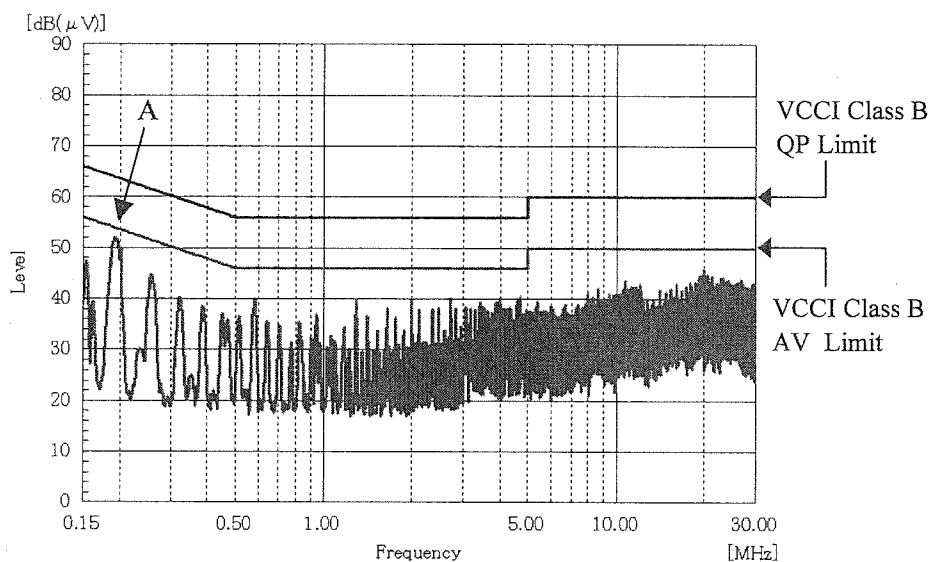

Phase : L

Point B (194kHz)		
Ref. Data	Limit (dBuV)	Measure (dBuV)
QP	63.9	50.5
AV	53.9	46.8

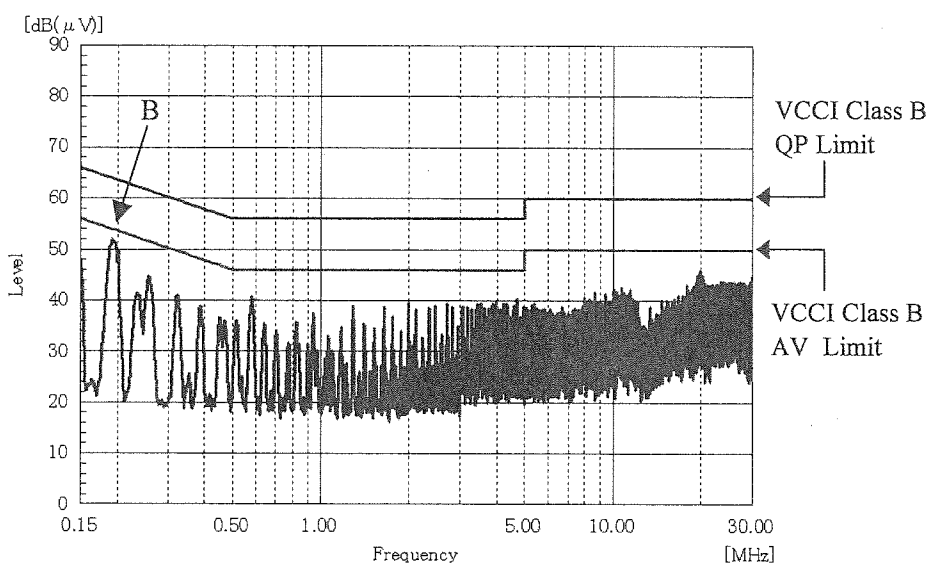

EN55011-B,EN55022-B,FCC-Bの限界値はVCCI class Bの限界値と同じ
Limit of EN55011-B,EN55022-B,FCC-B are same as its VCCI class B.

2.15 EMI 特性

Electro-Magnetic Interference characteristics

Conditions Vin : 230 VAC
Io : 100 %
Ta : 25 °C

雑音電界強度

Radiated Emission

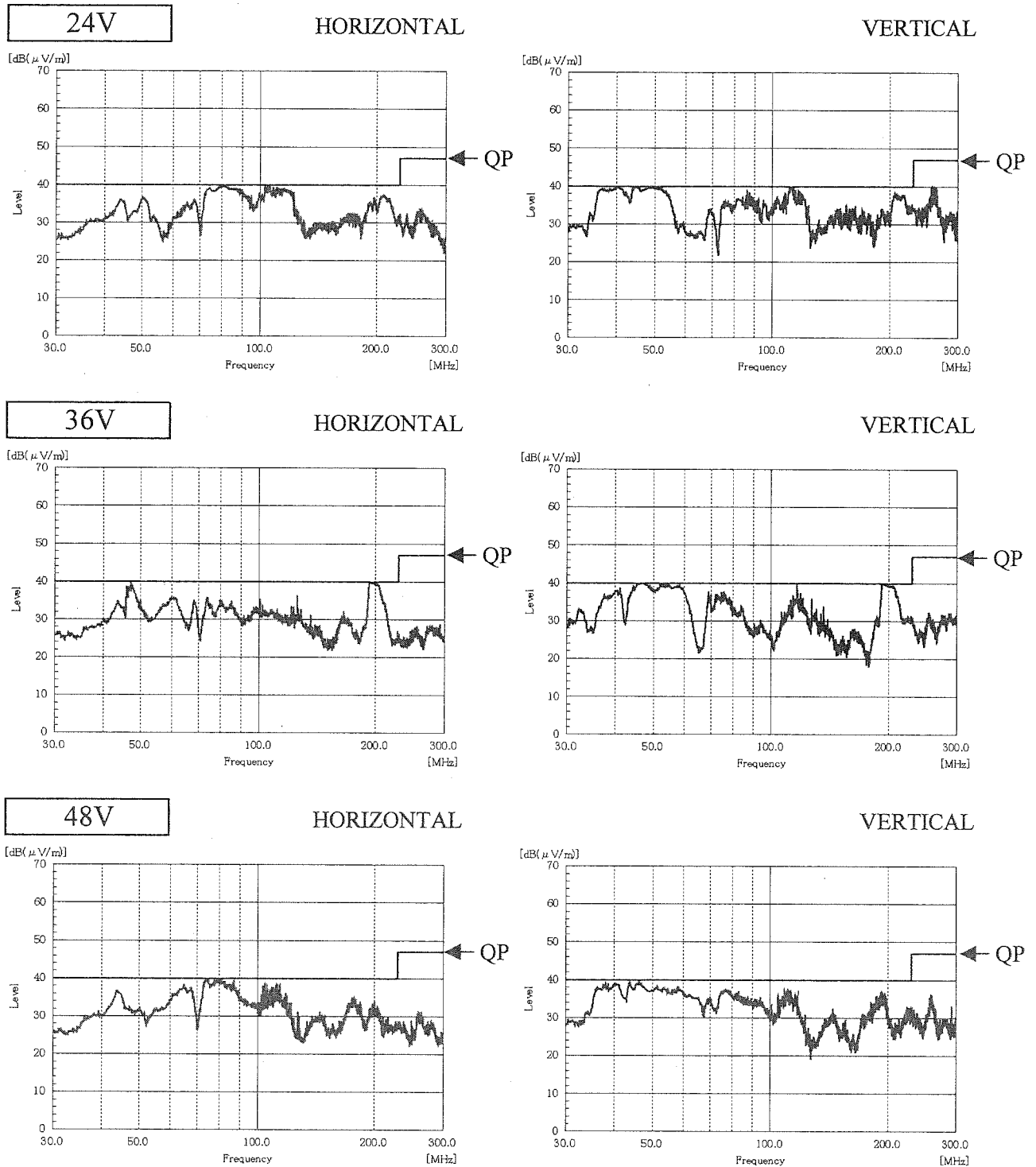

EN55011-B,EN55022-Bの限界値はVCCI class Bの限界値と同じ
Limit of EN55011-B,EN55022-B are same as its VCCI class B.

表示はピーク値
Indication is peak values.