



Thermal Management Guide

2005.8. Rev 3



SEOUL SEMICONDUCTOR CO., LTD.
148-29, Kasan-Dong, Keumchun-Gu, Seoul, Korea
TEL : 82-2-3281-6269 FAX : 82-2-857-5430

1. Introduction

LED have the special character that LED break out radiant power and heat when It is operating. Recently photo efficiency of LED is just 20% and almost residual power converts heat. But heat cause bad reliability and changes of electrical and optical character negatively. So power LEDs must dissipate heat from chip in that package.

SSC Power Package is the latest product in SMT Package. Z-Power LED(includes white, red, green, blue, amber, etc.) is composed of lead frame, inner heat sink(slug), and thermoplastic body(housing). The chip is mounted on reflector made of metal. To dissipate heat from a package, it uses a metal PCB.

The bottom of Z-power LED is soldered on thermally improved metal PCB. Therefore, Z-Power package is proper one for a large output in the range of more than 1W. To get reliability and optimized performance, appropriate thermal management design is absolutely needed.

As all of the other electric materials, Z-power LED has thermal limits as well. Operating temperature is limited by junction Temperature(T_j) inside chip and operating power. So operating temperature shouldn't be over maximum T_j . These all brief explanation will be an introduction of thermal management to a design engineer. The concept to improve thermal design will be as follow below.



SEOUL SEMICONDUCTOR CO., LTD.
148-29, Kasan-Dong, Keumchun-Gu, Seoul, Korea
TEL : 82-2-3281-6269 FAX : 82-2-857-5430

2.Explanation of Basic Relationships

Power dissipation (P_d) in P-N junction of a chip is distributed by transferring heat through package. And it is transmitted by radiation and convection from free surface on package to the outside, by radiation or/and convection. But it is possible to neglect heat radiation transfer. Figure 1 is showing inside structure for discussion of static properties of Z-power LED.

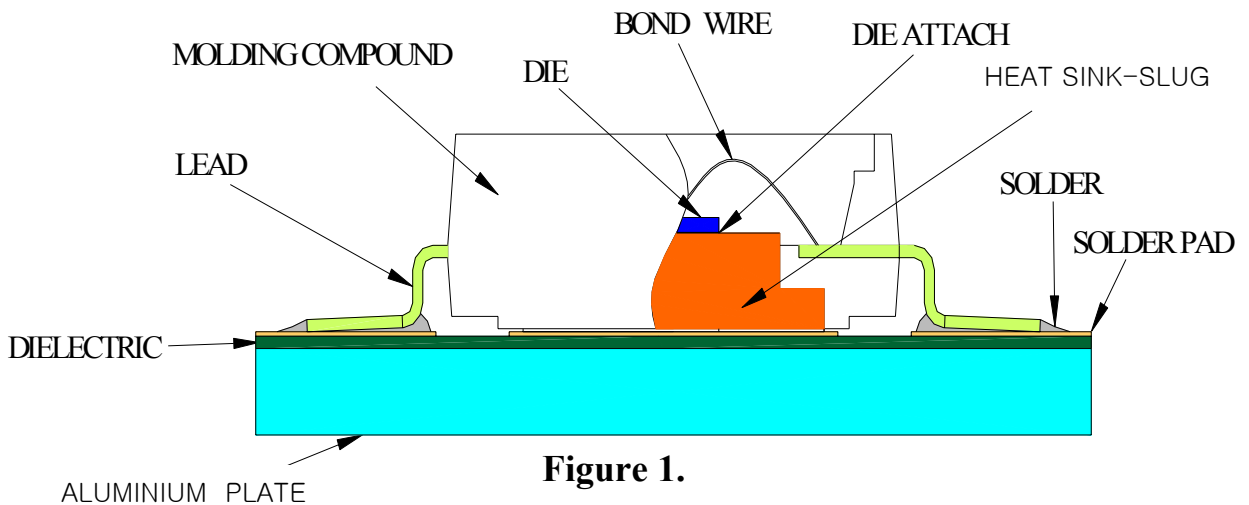

Figure 1.

Z-power LED is composed by mounted chip on bottom of heat sink slug and solder pad of AI-PCB. Heat sink slug is composed the materials as copper that has high thermal conductivity.



SEOUL SEMICONDUCTOR CO., LTD.
148-29, Kasan-Dong, Keumchun-Gu, Seoul, Korea
TEL : 82-2-3281-6269 FAX : 82-2-857-5430

3. Explanation of Thermal Analysis

Thermal resistance in Z-power LED package exists between P-N junction and heat spreader (such as resin, slug, housing etc). This value of thermal resistance can be determined by structure of package, for example, geometry, materials and size of LED bare chip, properties of materials used in LED package. In case of Z-power LED, The value of thermal resistance is $R_{\Theta JB}$ which is from junction to metal PCB bottom.

Thermal resistance value is depending on the application that heat flows from junction in the chip to environment. In case of thermal resistance, $R_{\Theta JA}$ can be affected by many factors, such as solder pad design, a position of component, material of PCB, and structure of PCB. $R_{\Theta BA}$ decides its particular character by transmitting heat to undefined part. (for example, external heat sink)

$R_{\Theta JS}$ is the thermal resistance from junction in chip to slug, $R_{\Theta SB}$ is the thermal resistance from junction in chip to slug. In SSC, The standard thermal resistance is $R_{\Theta JB}$ from junction in chip to bottom of the metal PCB

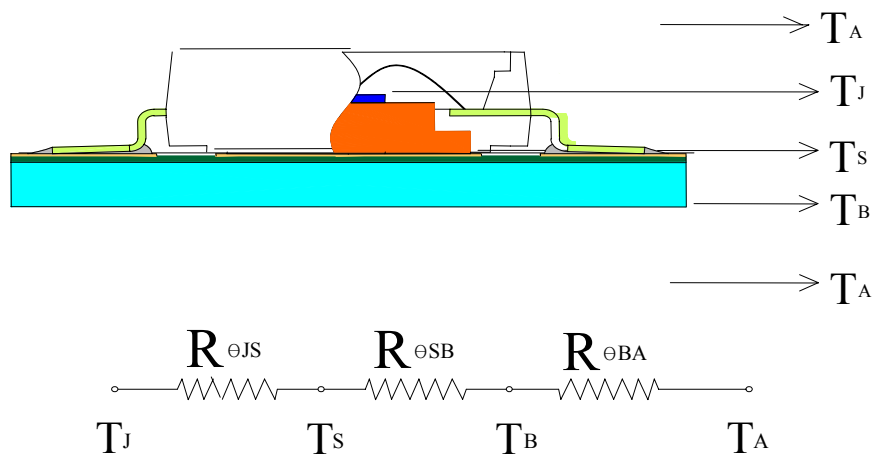

R_{Θ} of Z-Power LED is calculated from junction to metal PCB bottom.

The Equation to get the value of thermal resistance of Z Power LED will be as follow

$$R_{\Theta_{JA}} = R_{\Theta_{JS}} + R_{\Theta_{SB}} + R_{\Theta_{BA}} \quad \text{-----} \quad (1)$$

$$R_{\Theta_{JB}} = R_{\Theta_{JS}} + R_{\Theta_{SB}} \quad \text{-----} \quad (2)$$

$$T_J = R_{\Theta_{JB}} \cdot P_D + T_B \quad \text{-----} \quad (3)$$

Where: P_D – Power dissipation

T_B – Temperature of metal PCB bottom

***Equation 1,2,3 can be calculated from the “Thermal Ohm’s law”**

Conditions:

- Not considering thermal resistance of plastic housing body connected by the method in a row to approach “resistance network”(Figure 2.)

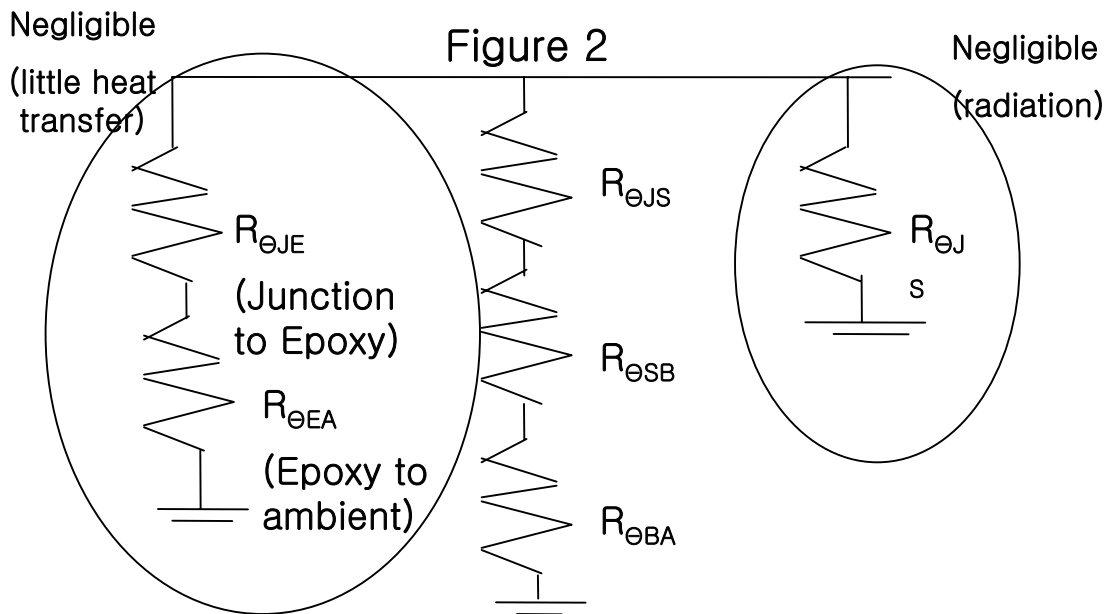

- Not considering the value of thermal resistance, $R_{\theta aj}$ while it's transmitted from fluid of circumstance to Junction, $R_{\theta j}$ while it's transmitted by radiation.

The value of $R_{\theta JB}$ of Z-Power LED can get in Equation 3 by measuring T_j , and also the value of resistance can be differed by Package design, or Chip

Cf. After finishing to design a LED package, the value, $R_{\theta JS} + R_{\theta SB}$, cannot be changed. (Namely, it is constant)

4. Calculation of Junction Temperature

The method to get the value of T_j can be measured by V_F (forward voltage) at low current experimentally. Normally V_F is the value changed by temperature. When applying voltage, the temperature of chip goes up, and V_F goes down. In case of measuring T_j , V_F should be measured with applying pulse low current, when it is $T_j = T_a$. The reason why it applies pulse current is to minimize the effect of heat that can be generated from chip. If we figure out the relation of T_a and V_F at every temperature, we can measure T_j indirectly, and get thermal resistance $R_{\theta JB}$ in Equation 3 by measuring input power

Some supposition need to explain the measurement of the T_j .

- i) The input power proportionally converts heat emerge in LED
- ii) At low currents, there is no heat in junction of LED
- iii) V_F is in inverse ratio to T_j in LED



SEOUL SEMICONDUCTOR CO., LTD.
148-29, Kasan-Dong, Keumchun-Gu, Seoul, Korea
TEL : 82-2-3281-6269 FAX : 82-2-857-5430

- Example

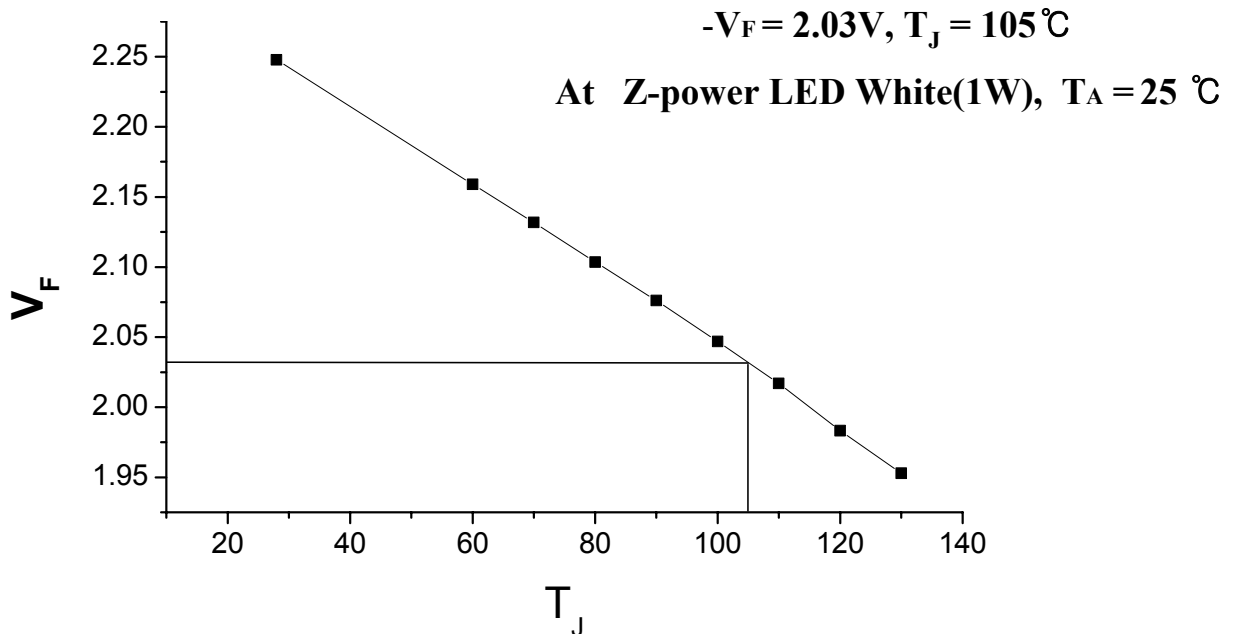

5. Calculate Thermal Resistance and Heat sink Sourcing

$$R_{\theta_{JB}} = (T_J - T_B) / P_d = (125^\circ C - 111^\circ C) / 1.4W = 10^\circ C/W$$

where: Z-power LED White(1W)

$$T_B = 110^\circ C \text{ (Temp of PCB bottom in 1W LED)}$$

$$T_j = 125^\circ C \text{ (Max. Junction Temperature)}$$

$$V_f = 4.0V, I_f = 350mA \text{ (Max } V_f \text{ at } 350mA)$$

$$P_d = V_f \times I_f = 4.0V \times 0.35A = 1.4W$$

In this case, $R_{\theta_{JB}} = 10^\circ C/W$

But Z-power LED have low $R_{\theta_{JB}}$ is $8^\circ C/W$ at 350mA in P1 package



SEOUL SEMICONDUCTOR CO., LTD.
148-29, Kasan-Dong, Keumchun-Gu, Seoul, Korea
TEL : 82-2-3281-6269 FAX : 82-2-857-5430

6. Summary

Normally thermal management is divided by the inside, and outside thermal management. In case of the inside thermal management, it manages from junction to outer surface of a package, and in case of the outside thermal management, it manages from a package to undefined part. In this case, controlling ambient temperature will be very important.

The outside thermal management includes a selection of cooling mode, heat sink design, material and adhesion(combination) process.

After selection of cooling mode, cooling system can be designed. Thermal resistance $R_{\Theta JB}$ and $R_{\Theta BA}$ have to be optimized for applications. But according to previous comments $R_{\Theta JB}$ can not be changed. Namely just only $R_{\Theta BA}$ must be optimized for using.

Generally Junction temperature of Z-power LED has to be maintained under the permitted temperature(125 Celsius)mentioned on the datasheet of Z-power LED

Life time is bound up with Junction temperature. At high junction temperature, Life time is reduce and at low junction temperature Life time is increasing.



SEOUL SEMICONDUCTOR CO., LTD.
148-29, Kasan-Dong, Keumchun-Gu, Seoul, Korea
TEL : 82-2-3281-6269 FAX : 82-2-857-5430

[Supplement to a Heat management for Heat Sink]

7.Heat Sink

Heat sink is a protective device that absorbs and dissipates the excess heat generated by a system. It is very important heat sink of shape and surface Area, because it is main factor for heat generation. Usually If heat sink would get Wider surface area, thicker plate and much more fin, heat dissipation is getting better.

8 Heat sink categories Cf. area :25mm × 25mm

	Normal load limit	Typical height	Mechanism
Passive heat sink	5~50 watts	~10mm	Natural convection
Active heatsink (ex. Fan)	10~160 watts	35~80mm	Forced convection
Liquid cooled cold plates	-	10~20mm	Fluid flow
Phase change recirculating system (ex. Heat pipe)	100~150 watts	5~10mm	Phase transition

9. Heat Sink Classification by type

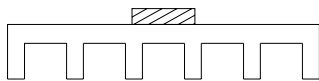

< Type 1 >

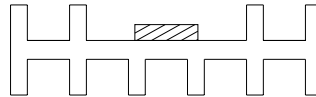

< Type 2 >

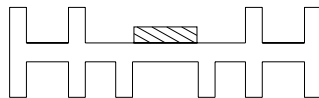

< Type 3 >

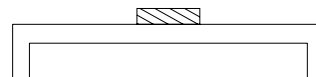

< Type 4 >

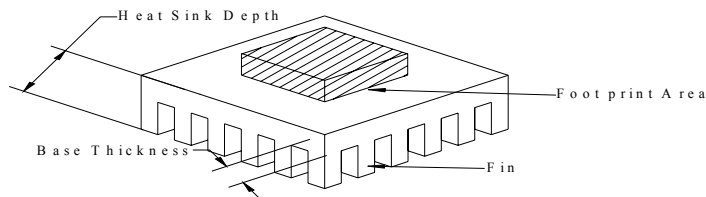

< Type 5 >



SEOUL SEMICONDUCTOR CO., LTD.
148-29, Kasan-Dong, Keumchun-Gu, Seoul, Korea
TEL : 82-2-3281-6269 FAX : 82-2-857-5430

- General heat sink type using natural convection is extrusion(Type 1,2,3,5)or plate(Type 4). According to location, array direction of LED packages, and quantities of used LED packages, extrusion heat sink can be Type 1,2,3,5 and Type 4 is normally used as plate type which has no typical.
- In case of Type 2,3, fin's pitch and length are different for each other and they can be used for other purpose
- Single side cutting for Type 1,2,3,4,and Cross(Both side) cutting for Type 5 can be divided by Fin cutting Type.
- In previous page there are 5 different heat sinks listed. But they are not all kind of heat sink. Therefore you should sort out it according to your purpose.

10.The method to optimize Heat Sink

It is possible to optimize heat sink geometry by use of computer simulation, however, heat sink should be sorted under thermal experiment in practical environment, because it can not be applied to all environmental factors. Therefore, the factors of heat sink are Interval of Fin(s), Fin 's Thickness(T_f), Base Thickness(T_b), Heat Sink's Depth(D_h), Fin's Height(F_s), and the number of Fin(N), except experimental condition used. In case of Fin Thickness (T_f), it should be within maximum 1.0mm because it has to be less than extrusion dimension possible. So, the other 5 things which are factors to design could be considered as factors for sorting, barring Fin Thickness (T_f)



SEOUL SEMICONDUCTOR CO., LTD.
148-29, Kasan-Dong, Keumchun-Gu, Seoul, Korea
TEL : 82-2-3281-6269 FAX : 82-2-857-5430

In case of designing each variable without optimizing total Heat Sink, create figures which users want to set as designing variables. In this way, it becomes the matter of one dimension so that optimizing time is able to be easier and faster. In order to sort out, Constraint function is necessary. This function includes temperature condition and measurement condition.

Temperature condition means that calculated degree on the surface of heat sink (T_H) is the same or smaller than target-designed temperature (T_G) in the standard of junction temperature.

Measurement condition is constraint condition decided by means of geometrical figure or in the range that designer sets outline dimension which is maximally permitted.

Constraint function:

$$G1(x) = T_H - T_G \leq 0$$
$$G2(x) = D_H - (L_{Faw} + T_B) \leq 0$$
$$G3(x) = -D_H + D_{HLL} \leq 0$$
$$G4(x) = -S + S_{LL} \leq 0$$
$$G5(x) = F_H - W_{haw} \leq 0$$
$$G6(x) = -F_H + F_{HLL} \leq 0$$
$$G7(x) = -T_B + T_{BLL} \leq 0$$
$$G8(x) = -N + N_{LL} \leq 0$$
$$G9(x) = D_H - T_B - 5S \leq 0$$

Where,

W_{haw} : Heat Sink width of maximum allowance

L_{Faw} : Heat Sink Fin length of maximum allowance



SEOUL SEMICONDUCTOR CO., LTD.
148-29, Kasan-Dong, Keumchun-Gu, Seoul, Korea
TEL : 82-2-3281-6269 FAX : 82-2-857-5430

$D_{HLL}, S_{LL}, F_{HLL}, T_{BLL}, N_{LL}$:The value of Lower Limit for each designing variable.

$G9(x)$:Constraint function whose interval of fins is less than 5.

This function is applied because the product is able to be transformed or damaged when it comes to general extrusion process.

***Notes**

The above formula is not able to be absolute solutions and it has some exceptions because this is one of the examples for the way of selection of Heat sink.

11. Heat Sink Test Example

- Test Purpose

The Heat Sink Test Example helps end-users select the best heat sink by measuring temperature difference at equilibrium or steady state after the selection of the one of Heat Sinks which is fit to the constraint condition mentioned in the clause function $G(3)$.

- Test conditions

LED – Z-power LED White(5W)

$T_a = 25^{\circ}\text{C}$

-Heat Sink and Z-power LED are assembled by means of Thermal grease

-Using test box to confirm reappearance and to control natural convection.

-Heat Sink is Horizontal on insulating sheet.



SEOUL SEMICONDUCTOR CO., LTD.
148-29, Kasan-Dong, Keumchun-Gu, Seoul, Korea
TEL : 82-2-3281-6269 FAX : 82-2-857-5430

- Test Results

1



2

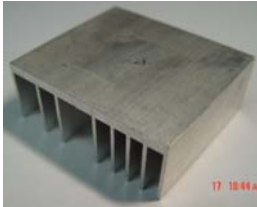

3

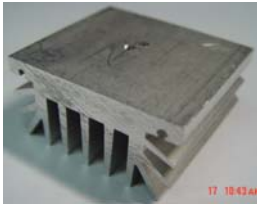

4



5



Specification & Size	$T_B(^{\circ}C)$	$R_{\theta_{BA}}(^{\circ}C/W)$
Size : 99.85 x 70.08 mm S : Irregular (Random) T_B : 3.18mm, D_H : 23.90mm F_H : 20.5mm N : 8ea Footprint: 625mm ² Power Dissipation:5W	37.9	2.58
Size : 59.60 x 53.08 mm S : Irregular (Random) T_B : 3.70mm, D_H : 25.95mm F_H : 22.10mm N : 8ea Footprint: 625mm ² Power Dissipation:5W	51.5	5.3
Size : 49.90 x 44.85 mm S : Irregular (Random) T_B : 8.90mm, D_H :27.82mm F_H : 19.00mm N : 11ea Foot print: 625mm ² Power Dissipation :5W	56.1	6.22
Size : 50.14 x 49.80 mm S : Irregular (Random) T_B : 2.42mm, D_H :29.84mm F_H : 26.00mm N : 48ea Foot print: 625mm ² Power Dissipation :5W	44.7	3.94
Size : 61.00 x 58.00 mm S : Irregular (Random) T_B : 3.90mm, D_H :20.50mm F_H : 17.00mm N : 121ea Foot print: 625mm ² Power Dissipation :5W	51.9	5.38



SEOUL SEMICONDUCTOR CO., LTD.
 148-29, Kasan-Dong, Keumchun-Gu, Seoul, Korea
 TEL : 82-2-3281-6269 FAX : 82-2-857-5430

12. T_j Vs forward current

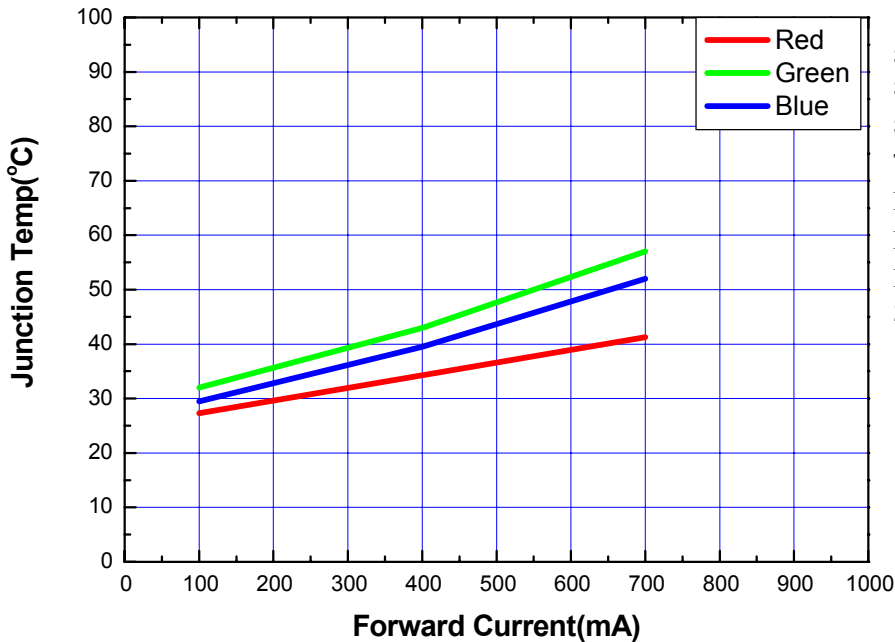
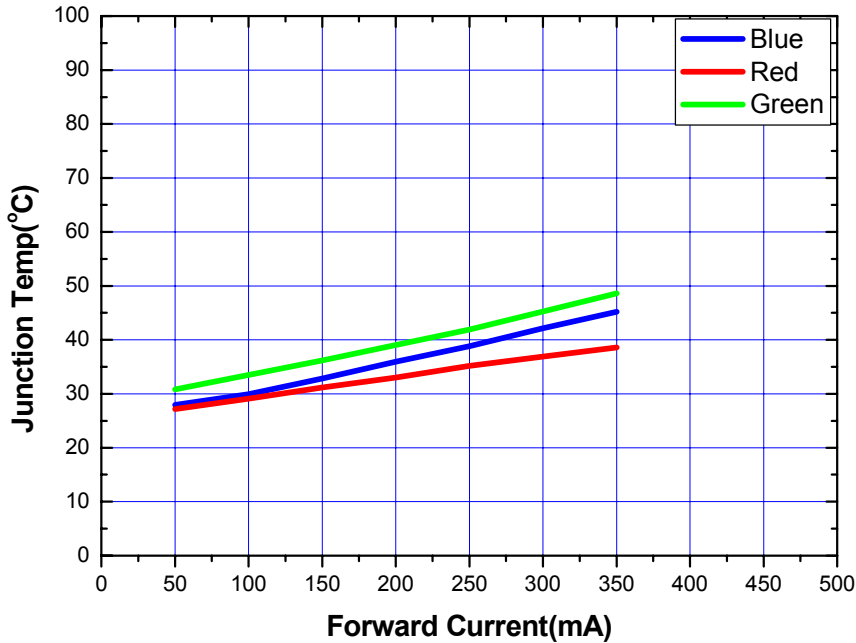

SEOUL SEMICONDUCTOR CO., LTD.
148-29, Kasan-Dong, Keumchun-Gu, Seoul, Korea
TEL : 82-2-3281-6269 FAX : 82-2-857-5430

13. Relative light Output Vs T_J

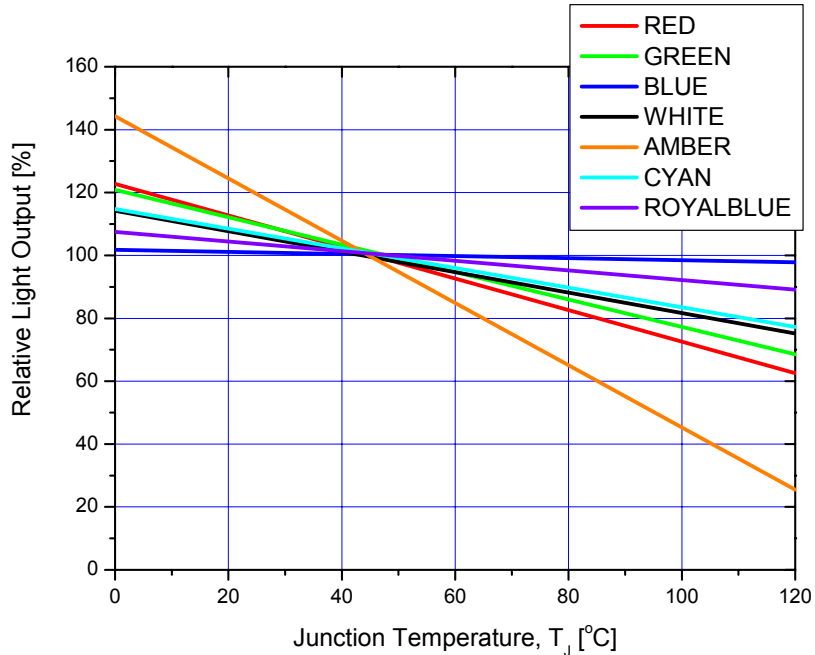

14. T_J Vs T_C (T_C is temperature of package case)

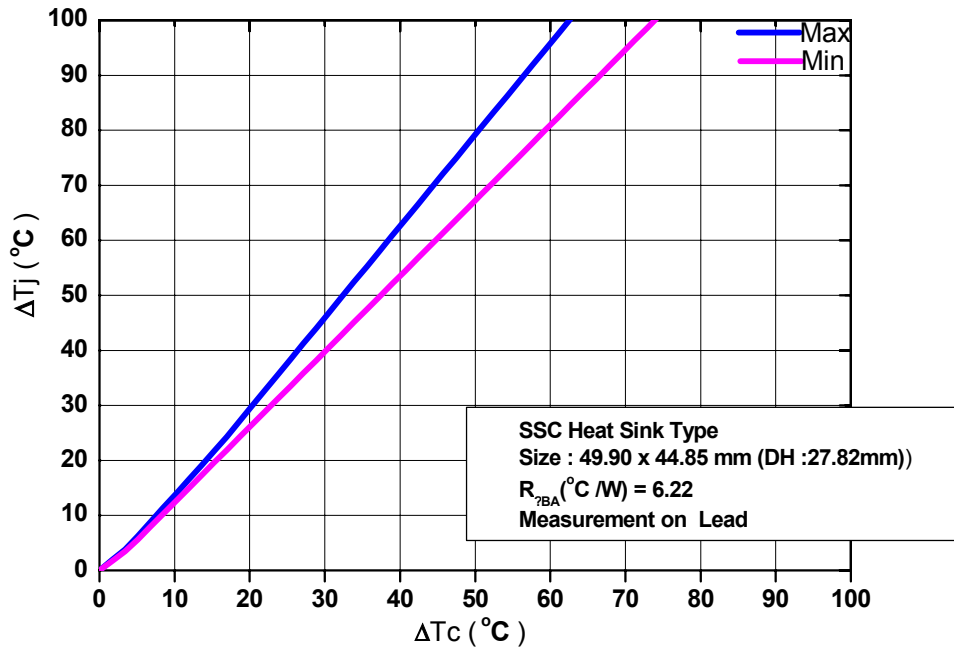

SEOUL SEMICONDUCTOR CO., LTD.
 148-29, Kasan-Dong, Keumchun-Gu, Seoul, Korea
 TEL : 82-2-3281-6269 FAX : 82-2-857-5430



Tc Point

ΔT_c in graph means difference Temperature between On and Off,

Also ΔT_j is same meaning with ΔT_c .

For example, When T_c temperature is 55°C on LED in 25°C ambient temperature, ΔT_c is 30°C , and ΔT_j is $40 \sim 45^\circ\text{C}$. So real T_j is about $65\sim 70^\circ\text{C}$ for $T_j = T_a + \Delta T_j$.



SEOUL SEMICONDUCTOR CO., LTD.
148-29, Kasan-Dong, Keumchun-Gu, Seoul, Korea
TEL : 82-2-3281-6269 FAX : 82-2-857-5430

15. Life time Vs T_j

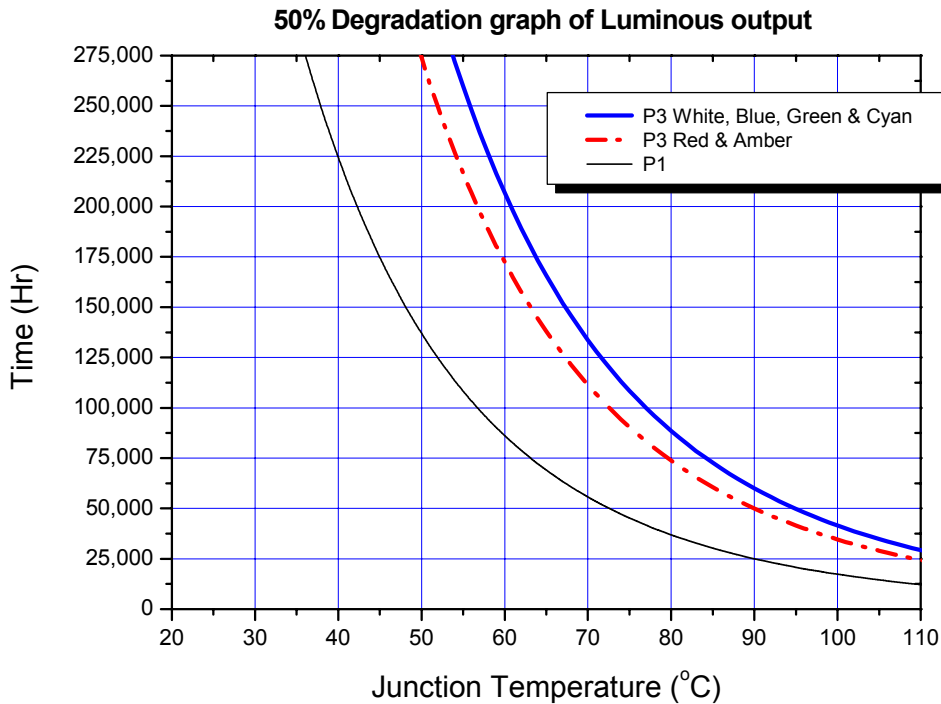

*This calculation can be done using the Arrhenius Model as shown below

$$R(t) = \exp(-\lambda t)$$

$$\lambda_2 = \lambda_1 \exp\left[\frac{E_A}{k} \left(\frac{1}{T_1} - \frac{1}{T_2}\right)\right]$$

where

$R(t)$ = Probability that unit will operate at time t

λ = failure rate

t = Time component is on

λ_1 = failure rate at junction temperature T_1

λ_2 = failure rate at junction temperature T_2

E_A = activation energy, in units eV

k = Boltzmann's constant ($8.617 \times 10^{-5} \text{ eV/}^\circ\text{K}$)

T = junction temperature in $^\circ\text{K}$ ($^\circ\text{K} = ^\circ\text{C} + 273$)



SEOUL SEMICONDUCTOR CO., LTD.
 148-29, Kasan-Dong, Keumchun-Gu, Seoul, Korea
 TEL : 82-2-3281-6269 FAX : 82-2-857-5430

16. simulation

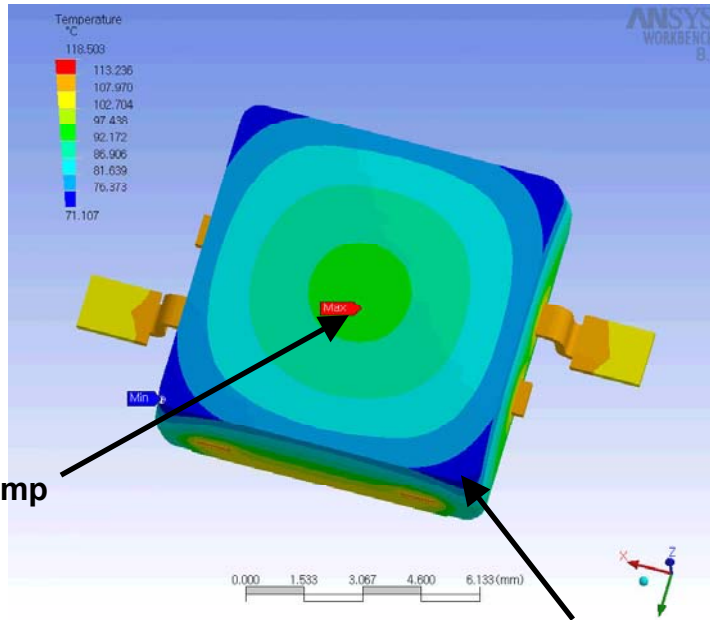

Resin surface Temp
113.2°C

1W blue
At IF=350 mA
In air

Reflector surface Temp
71.1°C

17. Actual measured data

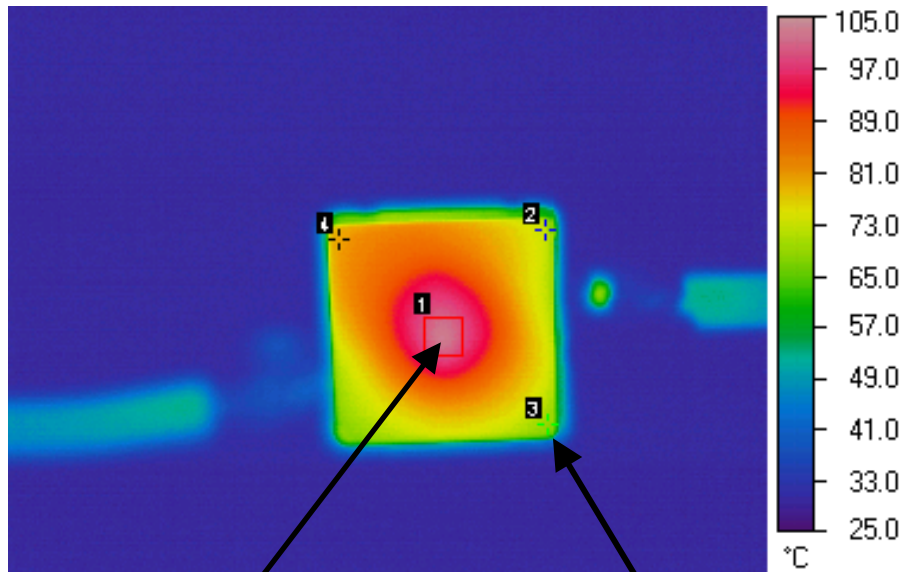

Resin surface Temp
102.6°C

1W blue
At IF=350 mA
In air

Reflector surface Temp
79.4°C



SEOUL SEMICONDUCTOR CO., LTD.
148-29, Kasan-Dong, Keumchun-Gu, Seoul, Korea
TEL : 82-2-3281-6269 FAX : 82-2-857-5430

18. R_{θ} Vs Heat sink area

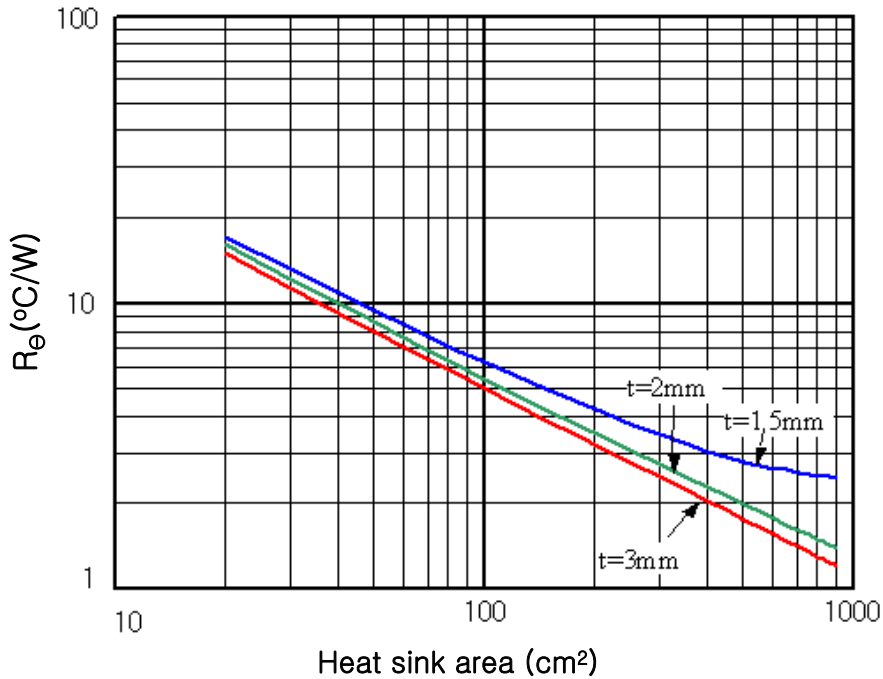

19. R_{θ} Vs Fan on/off

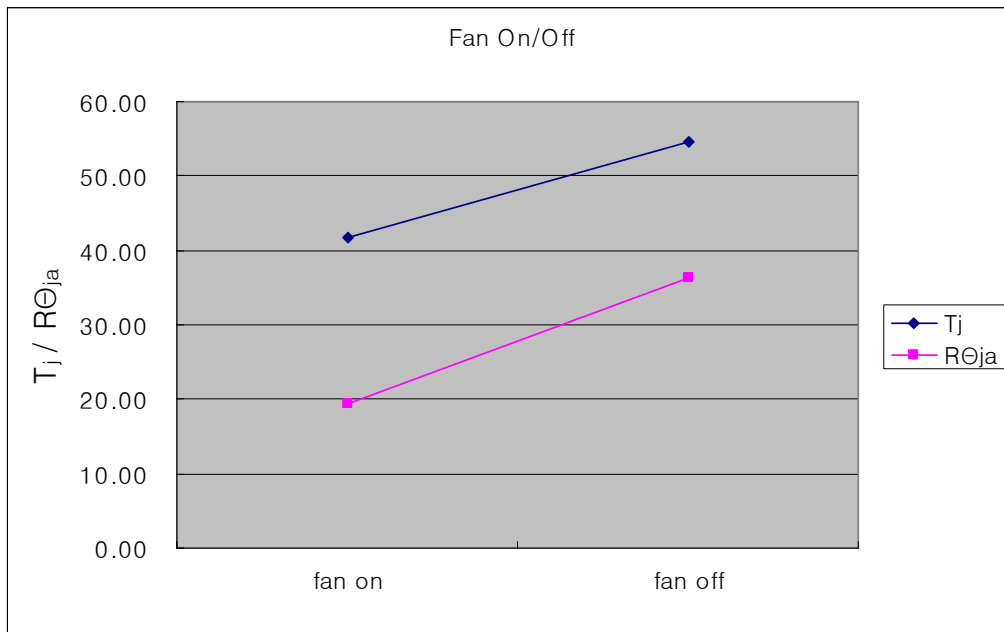

Heat sink
 25*25*5mm,
 fin 20,
 surface area
 6800 mm^2
 Aluminum
 LED 1W red
 350mA
 Fan 1.2W



SEOUL SEMICONDUCTOR CO., LTD.
 148-29, Kasan-Dong, Keumchun-Gu, Seoul, Korea
 TEL : 82-2-3281-6269 FAX : 82-2-857-5430

18. Thermal Adhesive

When the power product of emitter type is attached on the metal PCB, we recommend a reflow process. If customer wants to attach a metal PCB on big heat sink or when It is not possible to attach the emitter type on heat sink in reflow process, we recommend to use thermal adhesive.

There are two kind of thermal adhesive grease and tape. It ordinary use thermal adhesive tape to attach on the wide face and thermal adhesive grease to attach on the narrow face. The flat face is better. When customer uses thermal adhesives, avoid to bring out air void between thermal adhesive and the attached face. The void block the thermal transfer in package.

Customer can consult following the data sheet about some kind of thermal adhesive.

Type	Product Name	Thermal Resistant Experiment Result in SSC	Thermal Conductivity	Company
Thermal Adhesive Tape	Bond play 100	11 K/W thickness :0.127mm area: 50mm ² (on slug)	0.8W/mK	Burgquist company
	9882	5K/W thickness: 0.05mm Area:625mm ² (on metal pcb)	0.6W/mK	3M
	Bond play 100	2K/W thickness: 0.127mm Area:625mm ² (on metal pcb)	0.8W/mK	Burgquist company
Thermal Adhesive Grease	384	1.2K/W thickness :about0.01mm area: 50mm ² (on slug)	0.757W/mK	Henkel
	TCR	1.4 K/W thickness:about0.01mm area: 50mm ² (on slug)	2.0W/mK	Electrotube
	Thermalink @38		0.815W/mK	Holdtite



SEOUL SEMICONDUCTOR CO., LTD.

148-29, Kasan-Dong, Keumchun-Gu, Seoul, Korea

TEL : 82-2-3281-6269 FAX : 82-2-857-5430

20. T_j Vs heat sink area

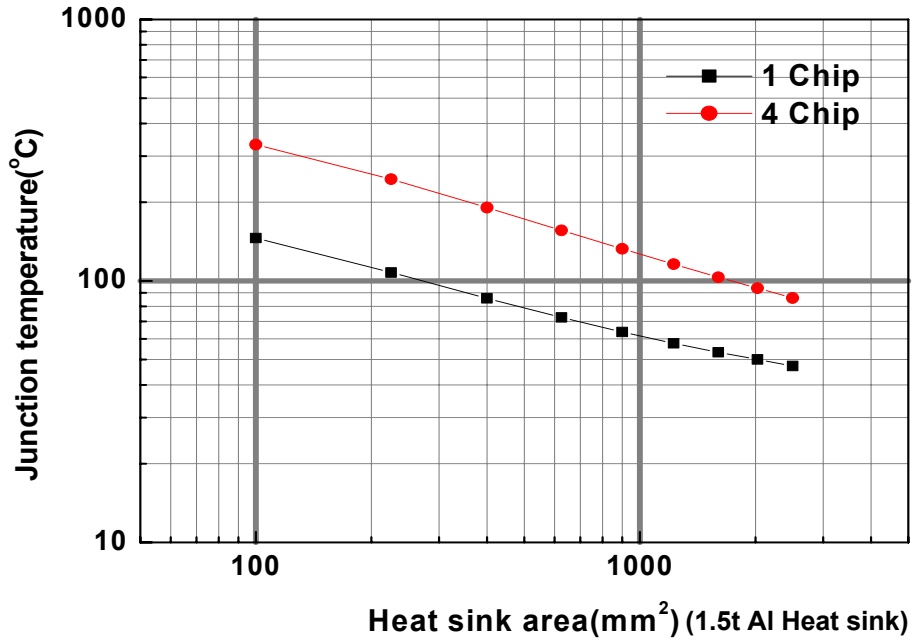

20. T_j Vs MCPCB Thickness

2.5*2.5*T square Al MCPCB on 1W P3 white.

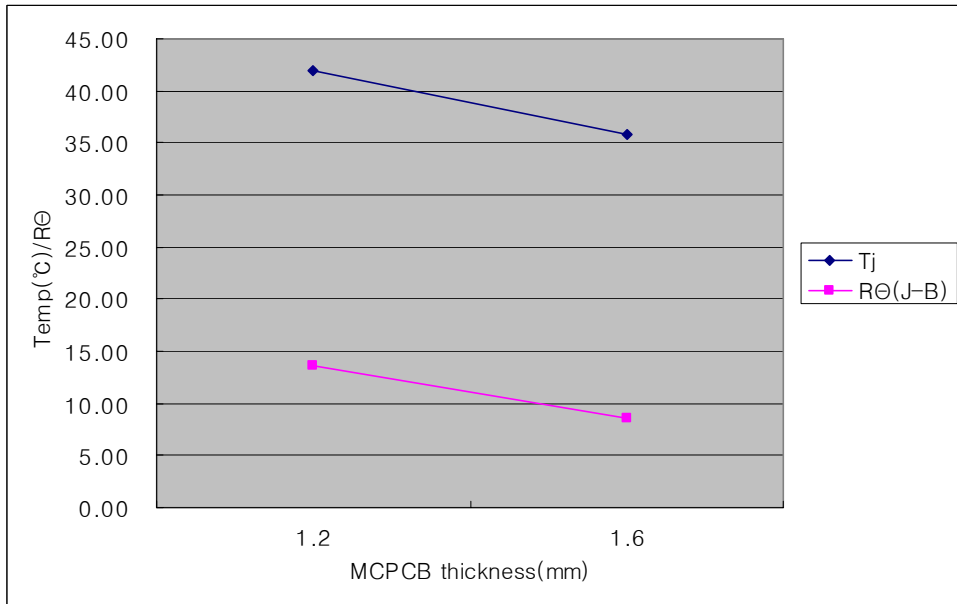

SEOUL SEMICONDUCTOR CO., LTD.
 148-29, Kasan-Dong, Keumchun-Gu, Seoul, Korea
 TEL : 82-2-3281-6269 FAX : 82-2-857-5430

22. Simulation results for passive heat sink(type 1)

Before simulation

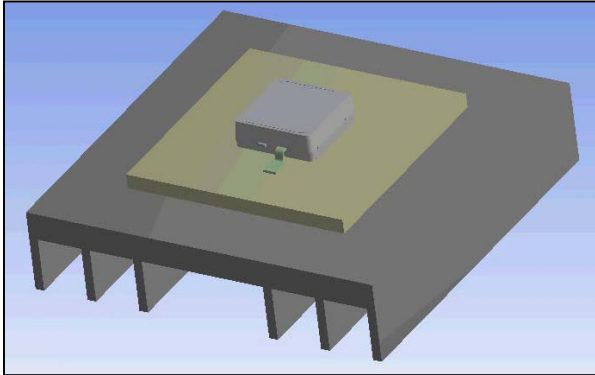

After simulation

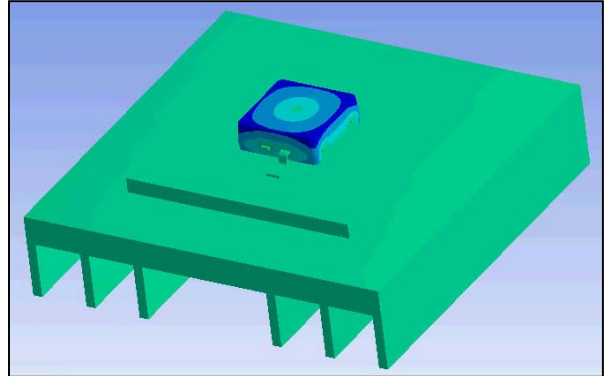

Note : Above these two figures shows just temperature distribution qualitatively not quantitatively

23. Trend of temperature change vs. base thickness change

(input load limit : 5~50 watts)

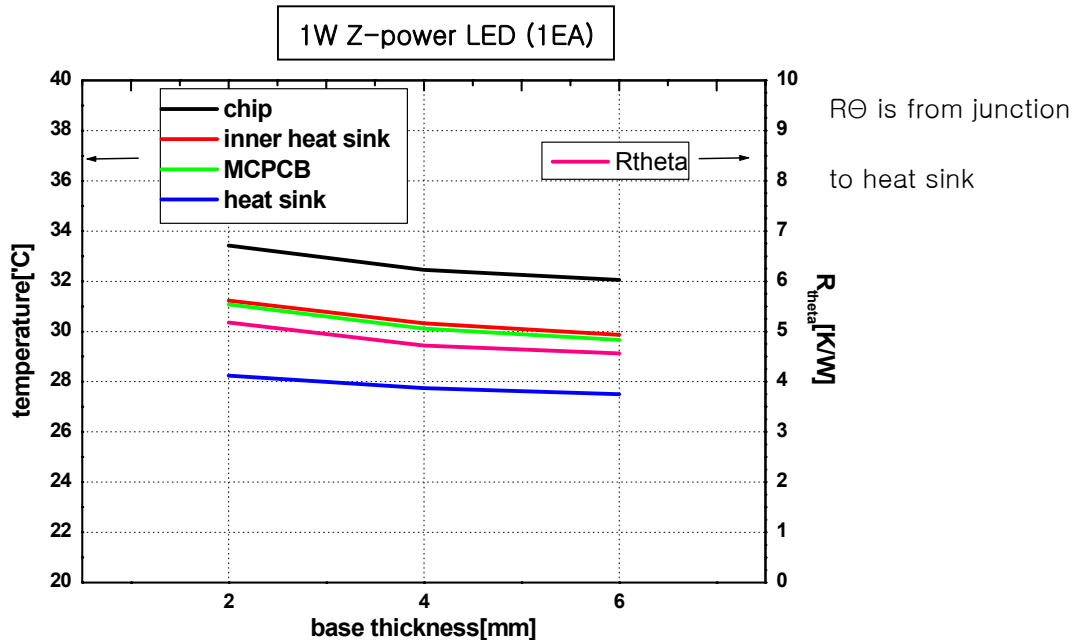

SEOUL SEMICONDUCTOR CO., LTD.
 148-29, Kasan-Dong, Keumchun-Gu, Seoul, Korea
 TEL : 82-2-3281-6269 FAX : 82-2-857-5430

2.5W Z-power LED (1EA)

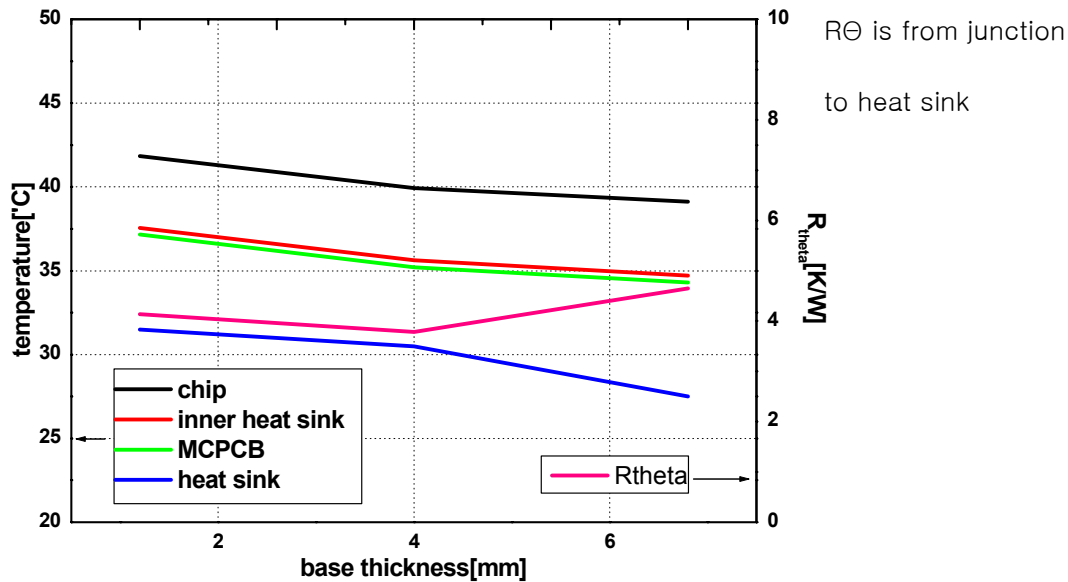

SEOUL SEMICONDUCTOR CO., LTD.
 148-29, Kasan-Dong, Keumchun-Gu, Seoul, Korea
 TEL : 82-2-3281-6269 FAX : 82-2-857-5430

24. Trend of temperature change vs. quantities of LEDs

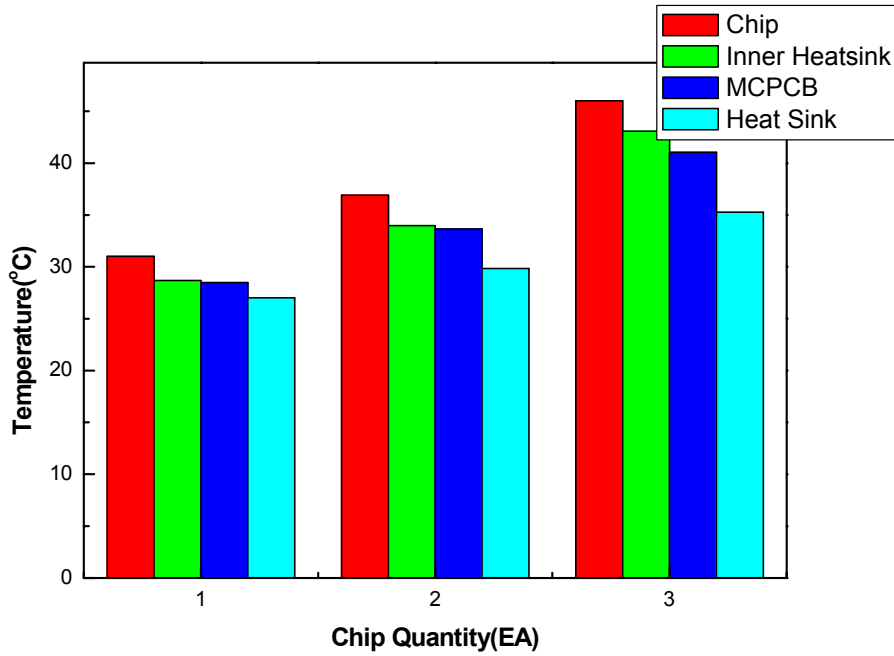

SEOUL SEMICONDUCTOR CO., LTD.
148-29, Kasan-Dong, Keumchun-Gu, Seoul, Korea
TEL : 82-2-3281-6269 FAX : 82-2-857-5430

24. Simulation for array LED on Metal PCB

When 1W blue LEDs array among 0.5~5mm each Led on 200*25*2 mm aluminum metal PCB , The following data is about Temperature of T_j , MCPCB and R_{θ} from junction to MCPCB.

The number of LED is 10.5, 10, 9.5, 8.5, 8 and 7 ea according to distance among LEDs.

