

SST-90 LEDs

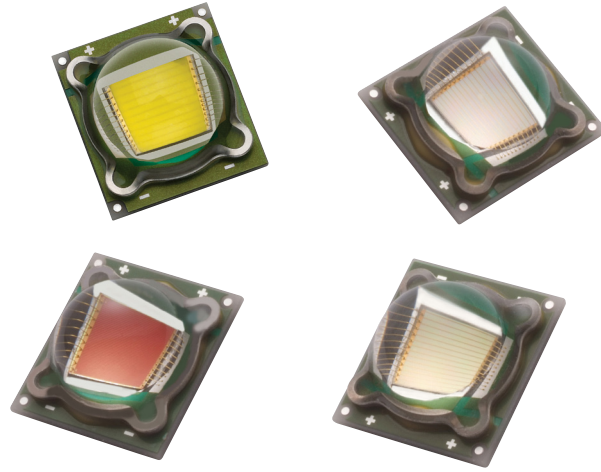

Table of Contents

| | |
|---|----|
| Technology Overview | 2 |
| Test Specifications | 2 |
| White Binning Structure | 3 |
| White Chromaticity Bins | 4 |
| Monochromatic Binning structure | 8 |
| Product Shipping & Labeling Information | 9 |
| Electrical Characteristics | 10 |
| SST-90 W Lifetime & Lumen Maintenance | 11 |
| Spectral Characteristics | 11 |
| SST-90- RGB Electrical Characteristics | 12 |
| Radiation Patterns | 17 |
| Thermal Resistance | 17 |
| Mechanical Dimensions | 18 |
| Solder Profile | 20 |
| Ordering Information | 21 |

Features:

- Extremely high optical output:
 - Over 2,100 White Lumens
 - Over 500 Red Lumens
 - Over 950 Green Lumens
 - Over 200 Blue Lumens
- Extremely high efficiency: Over 100 lumens per watt at 3.15A for white
- High thermal conductivity package - junction to case thermal resistance of only 0.64 °C/W
- Large, monolithic chip with uniform emitting area of 9 mm²
- Lumen maintenance of greater than 70% after 60,000 hours
- Environmentally friendly: RoHS compliant
- Variable drive currents: less than 1 A through 9 A
- High reliability
- Electrically isolated thermal path

Applications

- Replacement Lamps
- Architectural Lighting
- Retail Lighting
- Residential Lighting
- Consumer Portable
- Spot Lighting
- High Bay Lighting
- Wide Area Lighting
- Street Lighting
- Medical Lighting
- Emergency Vehicle Lighting
- Displays and Signage

Technology Overview

Luminus Big Chip LEDs™ benefit from a suite of innovations in the fields of chip technology, packaging and thermal management. These breakthroughs allow illumination engineers and designers to achieve solutions that are high brightness and high efficiency.

Photonic Lattice Technology

Luminus' photonic lattice technology enables large area LED chips with uniform brightness over the entire LED chip surface. The optical power and brightness produced by these large monolithic chips enable solutions which replace arc and halogen lamps where arrays of traditional high power LEDs cannot.

For red, green and blue LEDs, the photonic lattice structures extract more light and create radiation patterns that are more collimated than traditional LEDs. Having higher collimation from the source increases optical collection efficiencies and simplifies optical designs.

Packaging Technology

Thermal management is critical in high power LED applications. With a thermal resistance from junction to case of 0.64° C/W. Luminus SST-90 LEDs have the lowest thermal resistance of any LED on the market. This allows the LED to be driven at higher current densities while maintaining a low junction temperature, thereby resulting in brighter solutions

and longer lifetimes.

Reliability

Designed from the ground up, Luminus Big Chip LEDs are one of the most reliable light sources in the world today. Big Chip LEDs have passed a rigorous suite of environmental and mechanical stress tests, including mechanical shock, vibration, temperature cycling and humidity, and have been fully qualified for use in extreme high power and high current applications. With very low failure rates and median lifetimes that typically exceed 60,000 hours, Luminus Big Chip LEDs are ready for even the most demanding applications.

Environmental Benefits

Luminus LEDs help reduce power consumption and the amount of hazardous waste entering the environment. All Big Chip LED products manufactured by Luminus are RoHS compliant and free of hazardous materials, including lead and mercury.

Understanding Big Chip LED Test Specifications

Every Luminus LED is fully tested to ensure that it meets the high quality standards expected from Luminus' products.

Testing Temperature

Luminus core board products are typically measured in such a way that the characteristics reported agree with how the devices will actually perform when incorporated into a system. This measurement is accomplished by mounting the devices on a 40°C heat sink and allowing the device to reach thermal equilibrium while fully powered. Only after the device reaches equilibrium are the measurements taken. This method of measurement ensures that Luminus Big Chip LEDs perform in the field just as they are specified.

Luminus surface mount LEDs are typically tested with a 20mSec input pulse and a junction temperature of 25°C. Expected flux values in real world operation can be extrapolated based on the information contained within this product data sheet.

Multiple Operating Points (3.15, 6.3, 9.0 A)

The tables on the following pages provide typical optical and electrical characteristics. Since the LEDs can be operated over a wide range of drive conditions (currents from less than 1.0 A to 9.0 A, and duty cycle from <1% to 100%), multiple drive conditions are listed.

SST-90 LEDs are production tested at 3.15 A. The values shown at other 6.3 A and 9.0 A are for additional reference at other possible drive conditions.

SST-90 White Binning Structure

SST-90 white LEDs are tested for luminous flux and chromaticity at a drive current of 3.15 A (350 mA/mm²) and placed into one of the following luminous flux (FF) and chromaticity (WW) bins:

Flux Bins

| Flux Bin (FF) | Minimum Flux (lm) @ 3.15A | Maximum Flux (lm) @ 3.15A |
|---------------|---------------------------|---------------------------|
| L2 | 630 | 665 |
| L3 | 665 | 700 |
| M | 700 | 850 |
| M2 | 750 | 800 |
| M3 | 800 | 850 |
| N | 850 | 1,000 |
| N2 | 900 | 950 |
| N3 | 950 | 1,000 |

*Note: Luminus maintains a +/- 6% tolerance on flux measurements.

Chromaticity Bins

Luminus' Standard Chromaticity Bins: 1931 CIE Curve

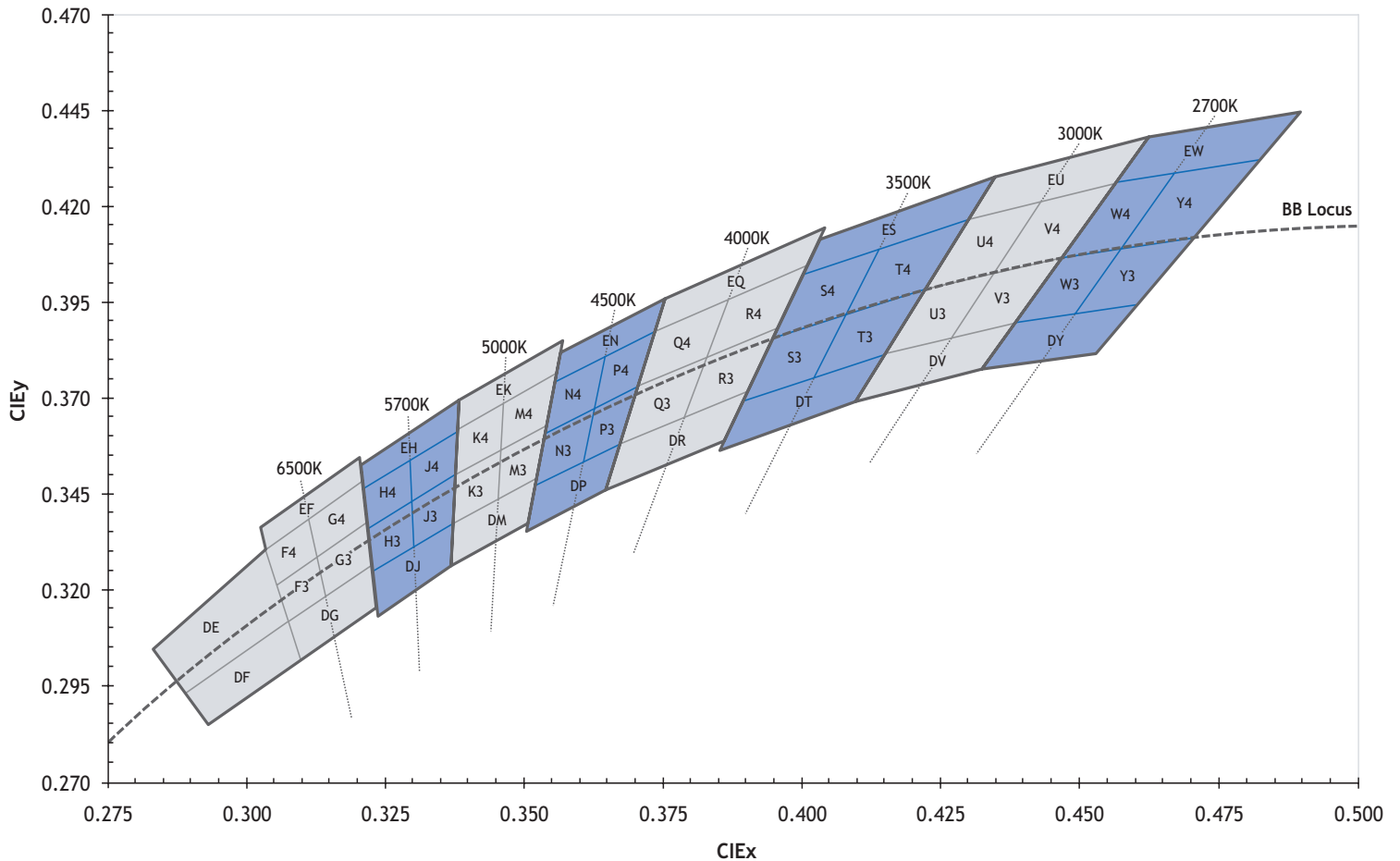

The following tables describe the four chromaticity points that bound each chromaticity bin. Chromaticity bins are grouped together based on the color temperature.

| 6500K Chromaticity Bins | | |
|-------------------------|-------|-------|
| Bin Code (WW) | CIEx | CIEy |
| DG | 0.307 | 0.311 |
| | 0.322 | 0.326 |
| | 0.323 | 0.316 |
| | 0.309 | 0.302 |
| F3* | 0.305 | 0.321 |
| | 0.313 | 0.329 |
| | 0.315 | 0.319 |
| | 0.307 | 0.311 |
| F4* | 0.303 | 0.330 |
| | 0.312 | 0.339 |
| | 0.313 | 0.329 |
| | 0.305 | 0.321 |
| G3* | 0.313 | 0.329 |
| | 0.321 | 0.337 |
| | 0.322 | 0.326 |
| | 0.315 | 0.319 |
| G4* | 0.312 | 0.339 |
| | 0.321 | 0.348 |
| | 0.321 | 0.337 |
| | 0.313 | 0.329 |
| EF | 0.302 | 0.335 |
| | 0.320 | 0.354 |
| | 0.321 | 0.348 |
| | 0.303 | 0.330 |
| DE | 0.283 | 0.304 |
| | 0.303 | 0.330 |
| | 0.307 | 0.311 |
| | 0.289 | 0.293 |
| DF | 0.289 | 0.293 |
| | 0.307 | 0.311 |
| | 0.309 | 0.302 |
| | 0.293 | 0.285 |

| 5700K Chromaticity Bins | | |
|-------------------------|-------|-------|
| Bin Code (WW) | CIEx | CIEy |
| DJ | 0.322 | 0.324 |
| | 0.337 | 0.337 |
| | 0.336 | 0.326 |
| | 0.323 | 0.314 |
| H3* | 0.321 | 0.335 |
| | 0.329 | 0.342 |
| | 0.329 | 0.331 |
| | 0.322 | 0.324 |
| H4* | 0.321 | 0.346 |
| | 0.329 | 0.354 |
| | 0.329 | 0.342 |
| | 0.321 | 0.335 |
| J3* | 0.329 | 0.342 |
| | 0.337 | 0.349 |
| | 0.337 | 0.337 |
| | 0.330 | 0.331 |
| J4* | 0.329 | 0.354 |
| | 0.338 | 0.362 |
| | 0.337 | 0.349 |
| | 0.329 | 0.342 |
| EH | 0.320 | 0.352 |
| | 0.338 | 0.368 |
| | 0.338 | 0.362 |
| | 0.321 | 0.346 |

*Sub-bins within ANSI defined quadrangles per ANSI C78.377-2008

| 5000K Chromaticity Bins | | |
|-------------------------|-------|-------|
| Bin Code (WW) | CIEx | CIEy |
| EK | 0.338 | 0.368 |
| | 0.356 | 0.384 |
| | 0.355 | 0.376 |
| | 0.338 | 0.362 |
| K3* | 0.337 | 0.349 |
| | 0.345 | 0.355 |
| | 0.345 | 0.343 |
| | 0.337 | 0.337 |
| K4* | 0.338 | 0.362 |
| | 0.347 | 0.369 |
| | 0.345 | 0.355 |
| | 0.337 | 0.349 |
| M3* | 0.345 | 0.355 |
| | 0.353 | 0.349 |
| | 0.352 | 0.372 |
| | 0.344 | 0.343 |
| M4* | 0.346 | 0.369 |
| | 0.355 | 0.376 |
| | 0.353 | 0.362 |
| | 0.345 | 0.355 |
| DM | 0.337 | 0.337 |
| | 0.352 | 0.349 |
| | 0.350 | 0.337 |
| | 0.336 | 0.326 |

| 4500K Chromaticity Bins | | |
|-------------------------|-------|-------|
| Bin Code (WW) | CIEx | CIEy |
| EN | 0.356 | 0.384 |
| | 0.376 | 0.396 |
| | 0.374 | 0.387 |
| | 0.355 | 0.374 |
| N3* | 0.353 | 0.360 |
| | 0.361 | 0.366 |
| | 0.359 | 0.352 |
| | 0.351 | 0.347 |
| N4* | 0.355 | 0.374 |
| | 0.364 | 0.381 |
| | 0.361 | 0.366 |
| | 0.353 | 0.360 |
| P3* | 0.361 | 0.366 |
| | 0.370 | 0.373 |
| | 0.367 | 0.358 |
| | 0.359 | 0.352 |
| P4* | 0.364 | 0.381 |
| | 0.374 | 0.387 |
| | 0.370 | 0.373 |
| | 0.361 | 0.366 |
| DP | 0.351 | 0.347 |
| | 0.367 | 0.358 |
| | 0.364 | 0.346 |
| | 0.350 | 0.335 |

*Sub-bins within ANSI defined quadrangles per ANSI C78.377-2008

| 4000K Chromaticity Bins | | |
|-------------------------|------------------|------------------|
| Bin Code (WW) | CIE _x | CIE _y |
| EQ | 0.376 | 0.396 |
| | 0.404 | 0.414 |
| | 0.401 | 0.404 |
| | 0.374 | 0.387 |
| Q3* | 0.370 | 0.373 |
| | 0.382 | 0.380 |
| | 0.378 | 0.365 |
| | 0.367 | 0.358 |
| Q4* | 0.374 | 0.387 |
| | 0.387 | 0.396 |
| | 0.382 | 0.380 |
| | 0.370 | 0.373 |
| R3* | 0.382 | 0.380 |
| | 0.395 | 0.388 |
| | 0.390 | 0.372 |
| | 0.378 | 0.365 |
| R4* | 0.387 | 0.396 |
| | 0.401 | 0.404 |
| | 0.395 | 0.388 |
| | 0.382 | 0.380 |
| DR | 0.367 | 0.358 |
| | 0.390 | 0.372 |
| | 0.386 | 0.359 |
| | 0.364 | 0.346 |

| 3500K Chromaticity Bins | | |
|-------------------------|------------------|------------------|
| Bin Code (WW) | CIE _x | CIE _y |
| ES | 0.403 | 0.411 |
| | 0.435 | 0.427 |
| | 0.430 | 0.417 |
| | 0.400 | 0.402 |
| S3* | 0.394 | 0.385 |
| | 0.407 | 0.392 |
| | 0.402 | 0.375 |
| | 0.389 | 0.369 |
| S4* | 0.400 | 0.402 |
| | 0.415 | 0.409 |
| | 0.407 | 0.392 |
| | 0.394 | 0.385 |
| T3* | 0.407 | 0.392 |
| | 0.422 | 0.399 |
| | 0.415 | 0.381 |
| | 0.402 | 0.375 |
| T4* | 0.415 | 0.409 |
| | 0.430 | 0.417 |
| | 0.422 | 0.399 |
| | 0.407 | 0.392 |
| DT | 0.389 | 0.369 |
| | 0.415 | 0.381 |
| | 0.409 | 0.369 |
| | 0.385 | 0.357 |

*Sub-bins within ANSI defined quadrangles per ANSI C78.377-2008



| 3000K Chromaticity Bins | | |
|-------------------------|------------------|------------------|
| Bin Code (WW) | CIE _x | CIE _y |
| EU | 0.435 | 0.427 |
| | 0.462 | 0.437 |
| | 0.456 | 0.426 |
| | 0.430 | 0.417 |
| U3* | 0.422 | 0.399 |
| | 0.434 | 0.403 |
| | 0.426 | 0.385 |
| | 0.415 | 0.381 |
| U4* | 0.430 | 0.417 |
| | 0.443 | 0.421 |
| | 0.434 | 0.403 |
| | 0.422 | 0.399 |
| V3* | 0.434 | 0.403 |
| | 0.447 | 0.408 |
| | 0.437 | 0.389 |
| | 0.426 | 0.385 |
| V4* | 0.443 | 0.421 |
| | 0.456 | 0.426 |
| | 0.447 | 0.408 |
| | 0.434 | 0.403 |
| DV | 0.415 | 0.381 |
| | 0.437 | 0.389 |
| | 0.431 | 0.377 |
| | 0.409 | 0.369 |

| 2700K Chromaticity Bins | | |
|-------------------------|------------------|------------------|
| Bin Code (WW) | CIE _x | CIE _y |
| EW | 0.462 | 0.437 |
| | 0.488 | 0.444 |
| | 0.481 | 0.432 |
| | 0.456 | 0.426 |
| W3* | 0.447 | 0.408 |
| | 0.458 | 0.410 |
| | 0.448 | 0.392 |
| | 0.437 | 0.389 |
| W4* | 0.456 | 0.426 |
| | 0.469 | 0.429 |
| | 0.458 | 0.410 |
| | 0.447 | 0.408 |
| Y3* | 0.458 | 0.410 |
| | 0.70 | 0.413 |
| | 0.459 | 0.394 |
| | 0.448 | 0.392 |
| Y4* | 0.469 | 0.429 |
| | 0.481 | 0.432 |
| | 0.470 | 0.413 |
| | 0.458 | 0.410 |
| DY | 0.437 | 0.389 |
| | 0.459 | 0.394 |
| | 0.452 | 0.382 |
| | 0.431 | 0.377 |

*Sub-bins within ANSI defined quadrangles per ANSI C78.377-2008

SST-90 RGB Bins Structure

SST-90 RGB LEDs are specified for luminous flux and wavelength at a drive current of 3.15 A (0.35 A/mm²) and placed into one of the following luminous flux (FF) and wavelength (WW) bins:

Flux Bins

| Color | Luminous Flux Bin (FF) | Minimum Flux (lm) @ 3.15A | Maximum Flux (lm) @ 3.15A |
|-------|------------------------|---------------------------|---------------------------|
| Red | BG | 275 | 350 |
| | BH | 350 | 475 |
| Green | CF | 640 | 775 |
| | CG | 775 | 940 |
| Blue | DE | 90 | 120 |
| | DF | 120 | 160 |
| | DG | 160 | 200 |

Wavelength Bins

| Color | Wavelength Bin (FF) | Minimum Wavelength @ 3.15A | Maximum Wavelength @ 3.15A |
|-------|---------------------|----------------------------|----------------------------|
| Red | R2 | 611 | 615 |
| | R3 | 615 | 619 |
| | R4 | 619 | 623 |
| | R5 | 623 | 627 |
| | R6 | 627 | 631 |
| | R7 | 631 | 635 |
| Green | G2 | 510 | 515 |
| | G3 | 515 | 520 |
| | G4 | 520 | 525 |
| | G5 | 525 | 530 |
| | G6 | 530 | 535 |
| | G7 | 535 | 540 |
| | G8 | 540 | 545 |
| Blue | B4 | 450 | 455 |
| | B5 | 455 | 460 |
| | B6 | 460 | 465 |
| | B7 | 465 | 470 |
| | B8 | 470 | 475 |

Note 1: Luminus maintains a +/- 6% tolerance on flux measurements.

Note 2: Only specific bins are available for large order, contact Luminus sales team for more information.

Product Shipping & Labeling Information

All SST-90 products are packaged and labeled with their respective bin as outlined in the tables and charts from pages 3 to 8. When shipped, each package will only contain one bin. The part number designation is as follows:

SST — 90 — WNNX — F11 — FF — WW

| Product Family | Chip Area | Color | Package Configuration | Flux Bin | Chromaticity Bin |
|----------------------|---------------------|-------------------------------|-----------------------|---------------------|-----------------------|
| Surface Mount (Lens) | 9.0 mm ² | CCT & CRI See Note 1 below | Internal Code | See page 3 for bins | See page 4-7 for bins |

Note 1: WNNX nomenclature corresponds to the following:

W = White

NN = color temperature, where:

65 corresponds to 6500K

X = color rendering index, where:

S (standard) corresponds to a typical CRI of 70

Example 1:

The part number SST-90-W65S-F11-N3-G4 refers to a 6500K standard CRI white, SST-90 emitter, with a flux range from 950 to 1,000 lumens and a chromaticity value within the box defined by the four points (0.313, 0.338), (0.321, 0.348), (0.322, 0.336), (0.312, 0.328).

SST — 90 — X — F11 — FF — WW

| Product Family | Chip Area | Color | Package Configuration | Flux Bin | Wavelength Bin |
|----------------------|---------------------|-------------------------------|-----------------------|---------------------|---------------------|
| Surface Mount (Lens) | 9.0 mm ² | R: Red G: Green B: Blue | Internal Code | See page 8 for bins | See page 8 for bins |

Example 2:

The part number SST-90-R-C11-BJ-R4 refers to a red, SST-90 surface mount, with a flux range of 475-600 lumens and a wavelength range of 619 nm to 623 nm.

Note 2: Some flux and chromaticity/ wavelength bins may have limited availability. Application specific bin kits, consisting of multiple bins, may be available. For ordering information, please refer to page 21 and reference the PDS-001692: SST-90 Binning & Labeling document.

Electrical Characteristics¹

Optical and Electrical Characteristics (T_j = 25 °C)

| Drive Condition ² | | 3.15 A | 9.0 A | |
|------------------------------|---------------------|-------------------------|--|-------------------|
| Parameter | Symbol | Values at Test Currents | Typical Values at Indicated Current ³ | Unit |
| Current Density | j | 0.35 | 1.0 | A/mm ² |
| Forward Voltage | V _{F, min} | 2.5 | | V |
| | V _{F, typ} | 3.25 | 3.87 | V |
| | V _{F, max} | 3.9 | | V |

Common Characteristics

| Parameter | Symbol | Values | Unit |
|--|--------------------|--------|-----------------|
| Viewing Angle | 2 θ _{1/2} | 100 | |
| Emitting Area | | 9.0 | mm ² |
| Emitting Area Dimensions | | 3 x 3 | mm×mm |
| Forward Voltage Temperature Coefficient ⁴ | | -2.45 | mV/°C |

Absolute Maximum Ratings

| Parameter | Symbol | Values | Unit |
|---|--------------------|----------|------|
| Maximum Current ⁵ | | 9.0 | A |
| Maximum Reverse Current | | N/A | |
| Maximum Junction Temperature ⁶ | T _{j-max} | 150 | °C |
| Storage Temperature Range | | -40/+100 | °C |

Note 1: Listed drive conditions are typical for common applications. SST-90 White devices can be driven at currents ranging from <1A to 9A and at duty cycles ranging from <1% to 100%. Drive current and duty cycle should be adjusted as necessary to maintain the junction temperature desired to meet application lifetime requirements.

Note 2: Unless otherwise noted, values listed are typical.

Note 3: Forward voltage temperature coefficient at 3.15A. Contact Luminus for value at other drive conditions.

Note 4: SST-90 White devices are designed for operation to an absolute maximum forward drive current 9A. Product lifetime data is specified at recommended forward drive currents. Sustained operation at absolute maximum currents will result in a reduction of device lifetime compared to recommended forward drive currents. Actual device lifetimes will also depend on junction temperature. Refer to APN-001522: Reliability Application Note for SST-90-W for further information. In pulsed operation, rise time from 10-90% of forward current should be larger than 0.5 microseconds.

Note 5: Lifetime dependent on LED junction temperature. Thermal calculations based on input power and thermal management system should be performed to ensure T_j is maintained below T_{j-max} rating or life will be reduced. Refer to APN-001522 for further information.

Note 6: CIE measurement uncertainty for white devices is estimated to be +/- 0.01.

Note 7: Special design considerations must be observed for operation under 1A. Please contact Luminus for further information.

Note 8: Caution must be taken not to stare at the light emitted from these LEDs. Under special circumstances, the high intensity could damage the eye.

Relative Output Flux vs. Forward Current¹

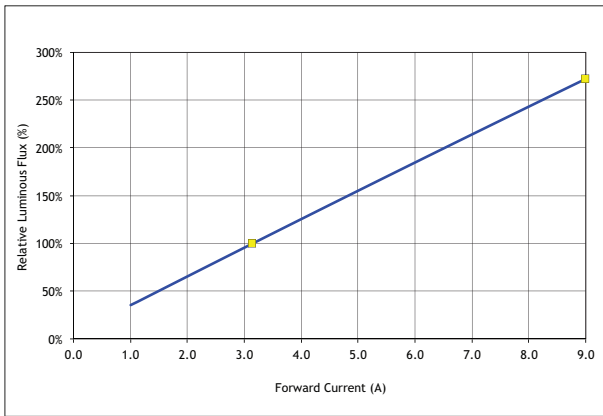

Forward Current vs. Forward Voltage

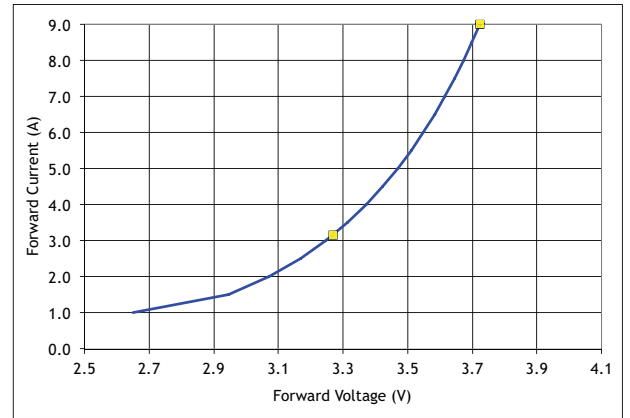

Mean Lifetime²

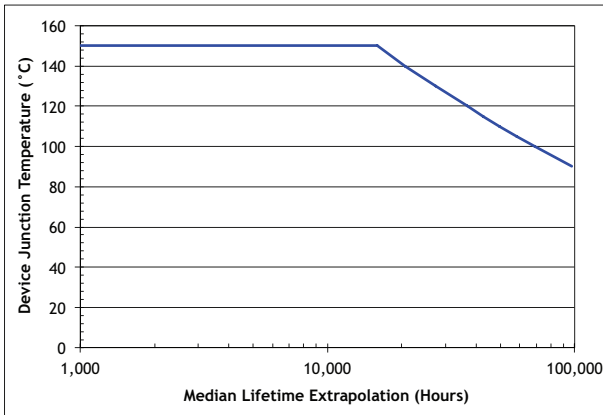

Lumen Maintenance vs. Time³

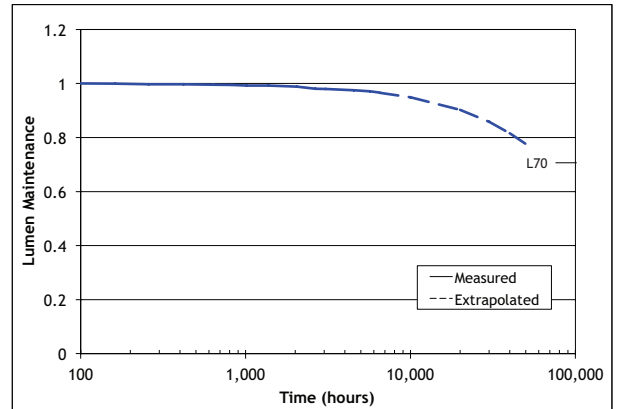

Typical Relative Spectral Power⁴

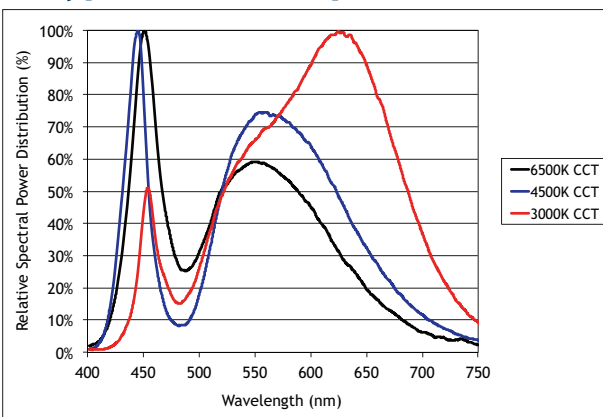

Current Derating Curve

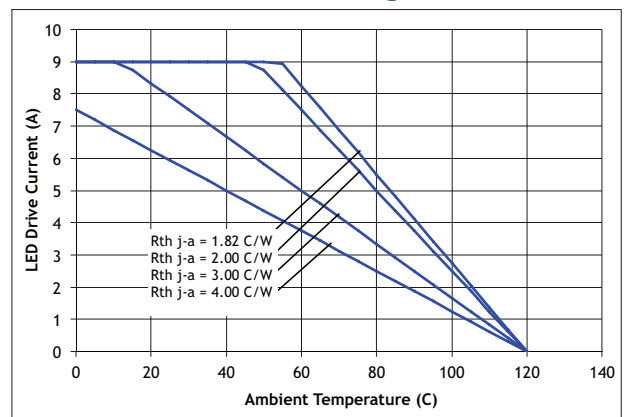

Note 1: Yellow squares indicate typical operating conditions.

Note 2: Mean expected lifetime in dependence of junction temperature at 0.35 A/mm² in continuous operation. Lifetime defined as time to 70% of initial intensity. Based on lifetime test data of uncoated GaN devices at this time. Data can be used to model failure rate over typical product lifetime (contact Luminus for lifetime reliability test data for 1A/mm² condition).

Note 3: Lumen maintenance in dependence of time at 0.35 A/mm² in continuous operation with junction temperatures of 100 °C.

Note 4: Typical spectrum at current density of 0.35 A/mm² in continuous operation.

Optical & Electrical Characteristics

| Red | | | | | |
|---|--------------------|---------------------|------------------|-------------------|--|
| Drive Condition ² | | 3.2 A Continuous | 6.3 A Continuous | | |
| Parameter | Symbol | Values ³ | | Unit | |
| Current Density | j | 0.35 | 0.7 | A/mm ² | |
| Forward Voltage | V _{Fmin} | TBD | - | V | |
| | V _F | 2.0 | 2.2 | V | |
| | V _{Fmax} | TBD | - | V | |
| Luminous Flux ⁴ | Φ _{V,typ} | 400 | 640 | lm | |
| Dominant Wavelength ⁵ | λ _d | 624 | 624 | nm | |
| FWHM | Δλ _{1/2} | 16 | 19 | nm | |
| Chromaticity Coordinates ^{6,7} | x | 0.695 | 0.699 | - | |
| | y | 0.305 | 0.301 | - | |

Relative Output Flux vs. Forward Current¹

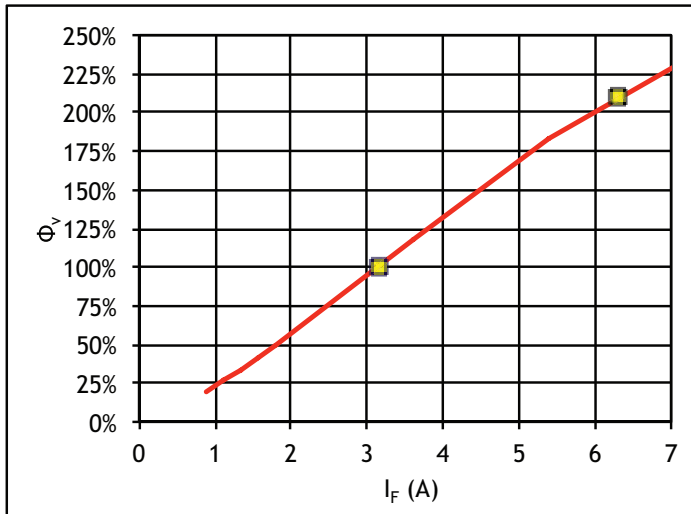

Forward Current vs. Forward Voltage

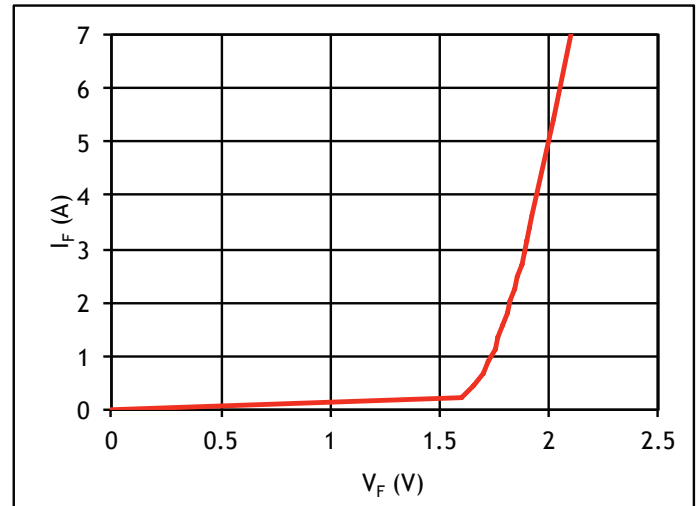

Yellow squares indicate reference drive conditions

Notes: See page 15

Optical & Electrical Characteristics

| Green | | | | | |
|---|--------------------|---------------------|------------------|-------------------|--|
| Drive Condition ² | | 3.15 A Continuous | 6.3 A Continuous | | |
| Parameter | Symbol | Values ³ | | Unit | |
| Current Density | j | 0.35 | 0.7 | A/mm ² | |
| Forward Voltage | V _{Fmin} | TBD | | V | |
| | V _F | 3.4 | 3.7 | V | |
| | V _{Fmax} | TBD | | V | |
| Luminous Flux ⁴ | Φ _{V,typ} | 855 | 1485 | lm | |
| Dominant Wavelength ⁵ | λ _d | 537 | 533 | nm | |
| FWHM | Δλ _{1/2} | 35 | 38 | nm | |
| Chromaticity Coordinates ^{6,7} | x | 0.205 | 0.175 | - | |
| | y | 0.740 | 0.730 | - | |

Relative Output Flux vs. Forward Current¹

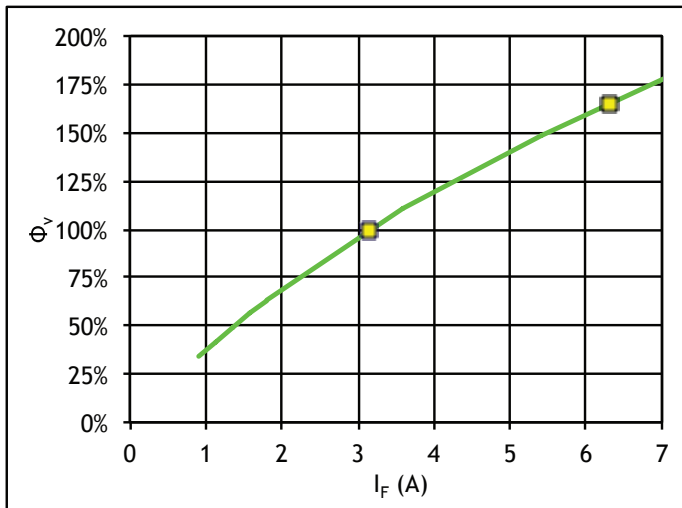

Forward Current vs. Forward Voltage

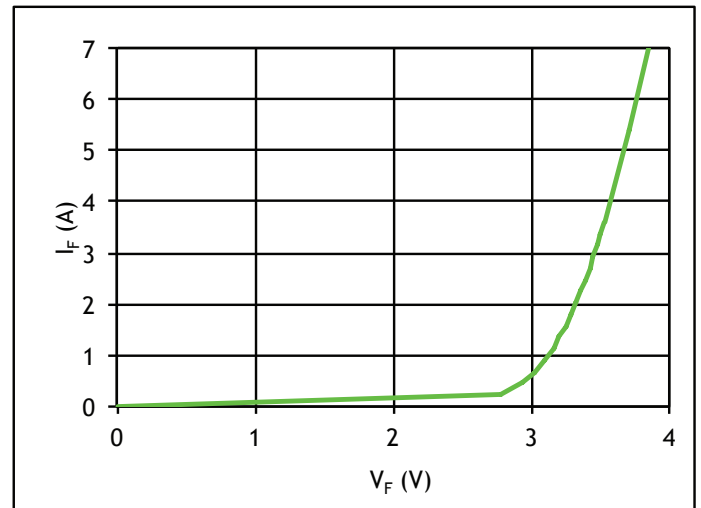

Yellow squares indicate reference drive conditions

Notes: See page 15

Optical & Electrical Characteristics

| Blue | | | | | |
|---|--------------------|----------------------|---------------------|-------------------|--|
| Drive Condition ² | | 3.15 A Continuous | 6.3 A Continuous | | |
| Parameter | Symbol | Values ³ | | Unit | |
| Current Density | j | 0.35 | 0.7 | A/mm ² | |
| Forward Voltage | V _{Fmin} | TBD | | V | |
| | V _F | 3.4 | 3.6 | V | |
| | V _{Fmax} | TBD | | V | |
| Luminous Flux ⁴ | Φ _{v,typ} | 180 | 315 | lm | |
| Dominant Wavelength ⁵ | λ _d | 465 | 464 | nm | |
| FWHM | Δλ _{1/2} | 21 | 24 | nm | |
| Chromaticity Coordinates ^{6,7} | x | 0.142 | 0.142 | 0.142 | |
| | y | 0.036 | 0.038 | 0.038 | |

Relative Output Flux vs. Forward Current¹

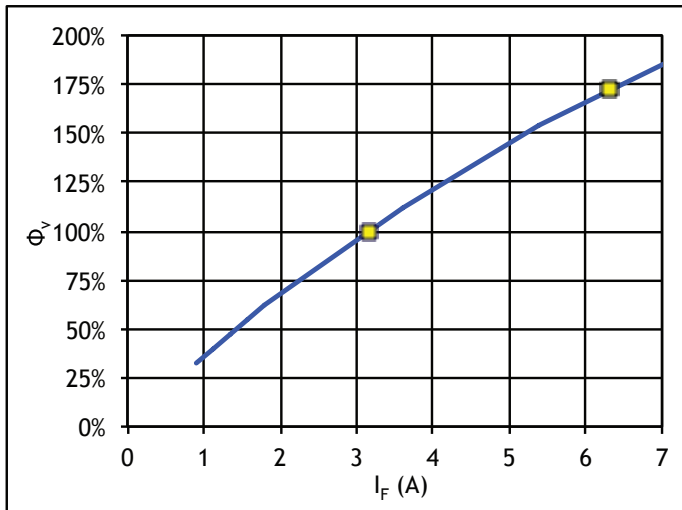

Forward Current vs. Forward Voltage

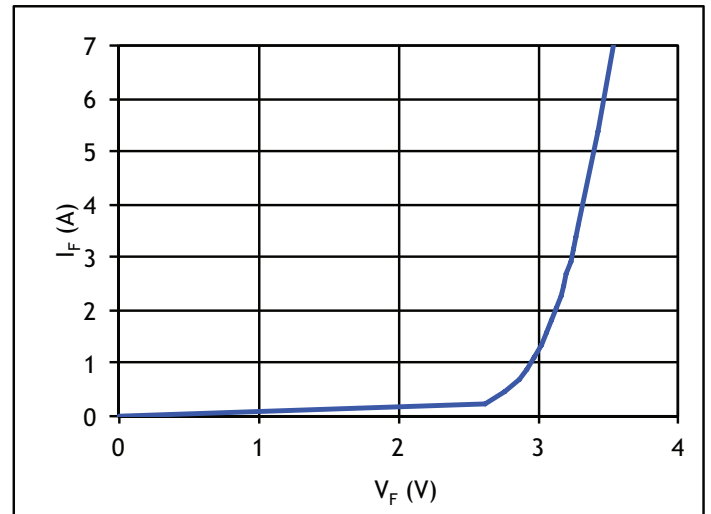

Yellow squares indicate reference drive conditions

Notes: See page 15

Optical & Electrical Characteristics Notes

- Note 1: All ratings are based on a junction test temperature $T_j = 25^\circ\text{C}$. See Thermal Resistance section for T_j definition.
- Note 2: Listed drive conditions are typical for common applications. SST-90 RGB devices can be driven at currents ranging from <1 A to 6.3 A and at duty cycles ranging from 1% to 100%. Drive current and duty cycle should be adjusted as necessary to maintain the junction temperature desired to meet application lifetime requirements.
- Note 3: Unless otherwise noted, values listed are typical. Devices are production tested and specified at 0.35mA. Other values are for reference only.
- Note 4: Total flux from emitting area at listed dominant wavelength. Reported performance is included to show trends for a selected power level. For specific minimum and maximum values, use bin tables. For product roadmap and future performance of devices, contact Luminus.
- Note 5: Minimum and Maximum Dominant Wavelengths are based on typical values +/- 5nm for Red, +/- 8nm for Green and +/- 6nm for Blue.
- Note 6: In CIE 1931 chromaticity diagram coordinates, normalized to X+Y+Z=1.
- Note 7: For reference only.

Common Characteristics

| | Symbol | Red | Green | Blue | Unit |
|---|-----------------------|---------|---------|---------|-----------------|
| Emitting Area | | 9.0 | 9.0 | 9.0 | mm ² |
| Emitting Area Dimensions | | 3.0x3.0 | 3.0x3.0 | 3.0x3.0 | mmxmm |
| Dynamic Resistance | Ω_{dyn} | 0.03 | 0.04 | 0.02 | Ω |
| Thermal Coefficient of Photometric Flux | | -0.96 | -0.18 | -0.007 | %/ °C |
| Thermal Coefficient of Radiometric Flux | | -0.52 | -0.20 | -0.17 | %/ °C |
| Thermal Coefficient of Junction Voltage | | -1.3 | -4.6 | -3.5 | mV/ °C |

Absolute Maximum Ratings

| | Symbol | Red | Green | Blue | Unit |
|------------------------------|-------------------|----------|----------|----------|------|
| Maximum Current | | 27 | 27 | 27ss | A |
| Maximum Junction Temperature | $T_{j\text{max}}$ | 125 | 150 | 150 | °C |
| Storage Temperature Range | | -40/+100 | -40/+100 | -40/+100 | °C |

- Note 1: SST-90 RGB LEDs are designed for operation to an absolute maximum current as specified above. Product lifetime data is specified at recommended forward drive currents. Sustained operation at or beyond absolute maximum currents will result in a reduction of device life ime compared to recommended forward drive currents. Actual device lifetimes will also depend on junction temperature. Refer to the lifetime derating curves for further information. In pulsed operation, rise time from 10-90% of forward current should be larger than 0.5 microseconds.
- Note 2: Lifetime dependent on LED junction temperature. Input power and thermal system must be properly managed to ensure lifetime. See charts on pg 16 for further information.

Light Output and Spectral Characteristics Over Heat Sink Temperature

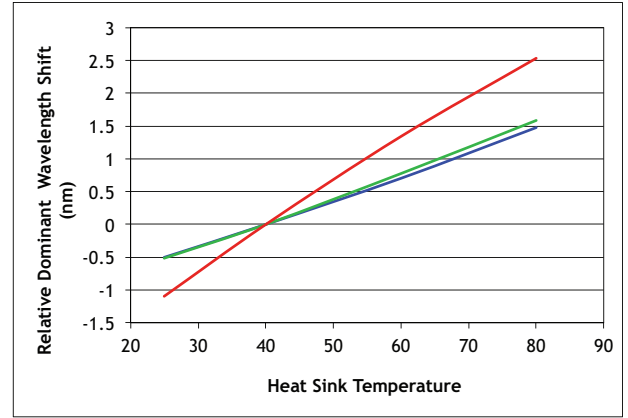
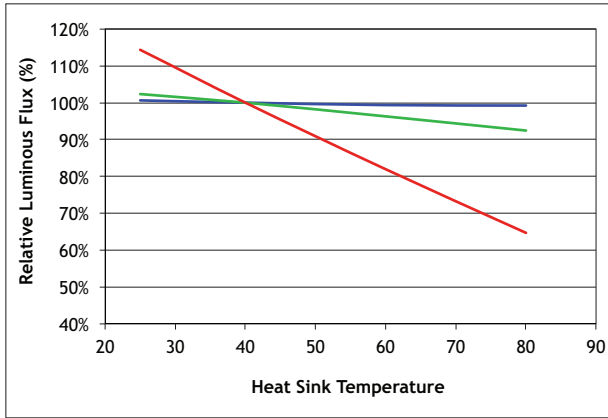

Median Lifetime Estimate vs. T_j^{13}

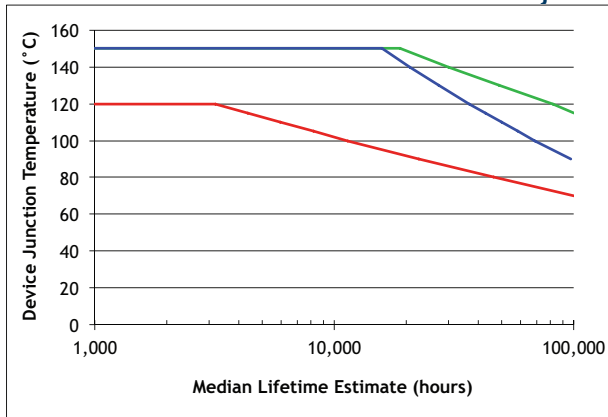

Lumen Maintenance¹⁴

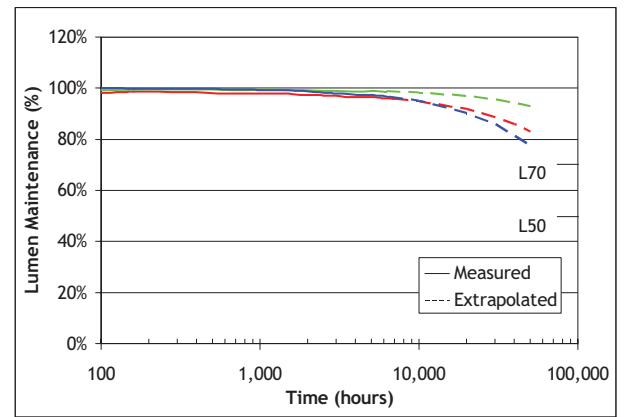

Typical Spectrum¹⁵

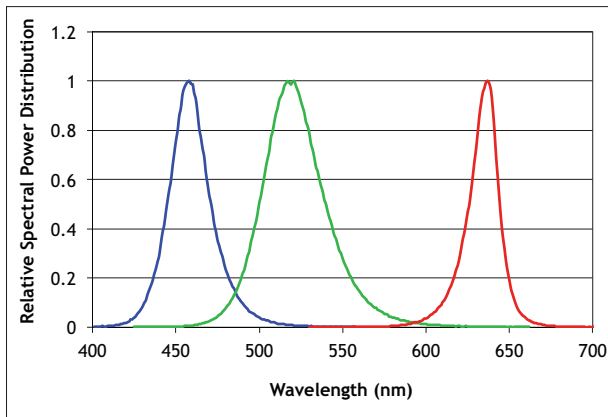

Relative Flux vs. Junction Temperature

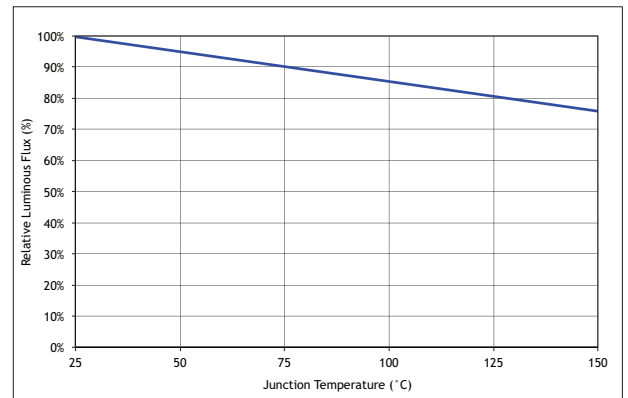

Note 13. Median lifetime estimate as a function of junction temperature at 0.35A/mm² in continuous operation. Lifetime defined as time to 70% of initial intensity. Based on preliminary lifetime test data. Data can be used to model failure rate over typical product lifetime.

Note 14. Lumen maintenance vs. time at 0.35A/mm² in continuous operation, Red junction temperature of 70°C, Green junction temperatures of 120°C, Blue junction temperatures of 100°C.

Note 15. Typical spectrum at current density of 0.35 A/mm² in continuous operation.

Typical Radiation Patterns

Typical Polar Radiation Pattern for White

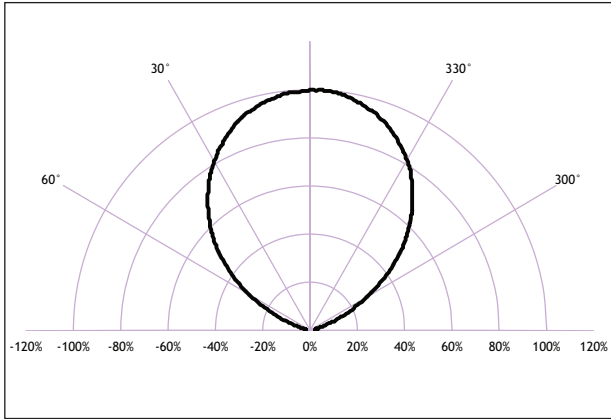

Typical Angular Radiation Pattern for White

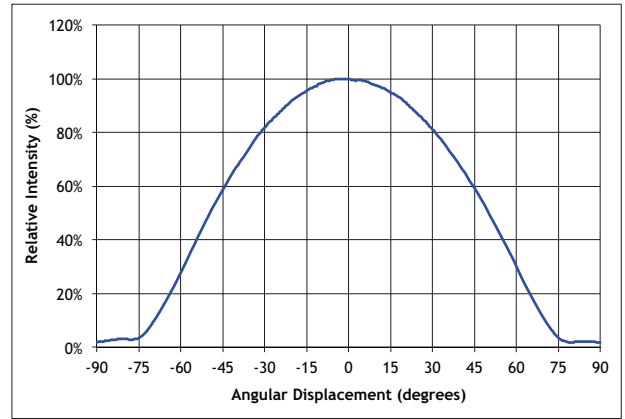

Typical Polar Radiation Pattern for Blue and Green

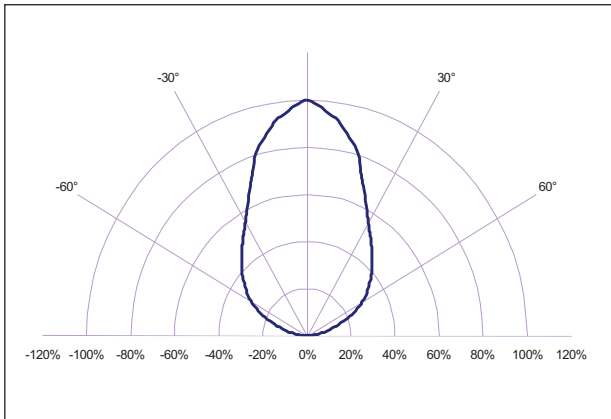

Typical Polar Radiation Pattern for Red

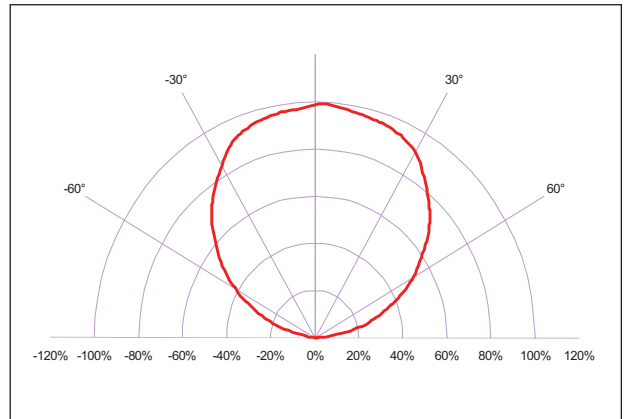

Thermal Resistance

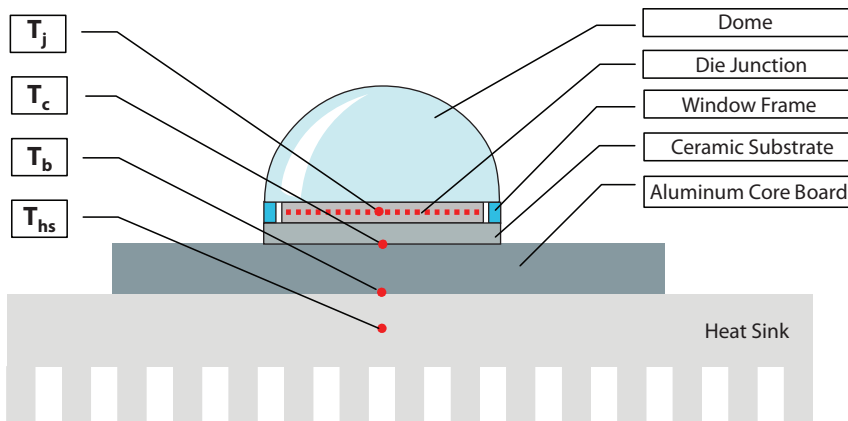

T_{hs} definition = 3 mm from core-board

Typical Thermal Resistance

| | |
|--------------|-----------|
| R_{j-c}^1 | 0.64 °C/W |
| R_{j-b}^1 | 2.02 °C/W |
| R_{j-hs}^2 | 2.15 °C/W |

Note 1: Thermal resistance values are based on FEA model results correlated to measured $R_{\theta j-hs}$ data.

Note 2: Thermal resistance is measured using a SAC305 solder, a Bergquist Al-clad MCPCB, and eGraf 1205 thermal interface material.

Mechanical Dimensions – SST-90 Emitter

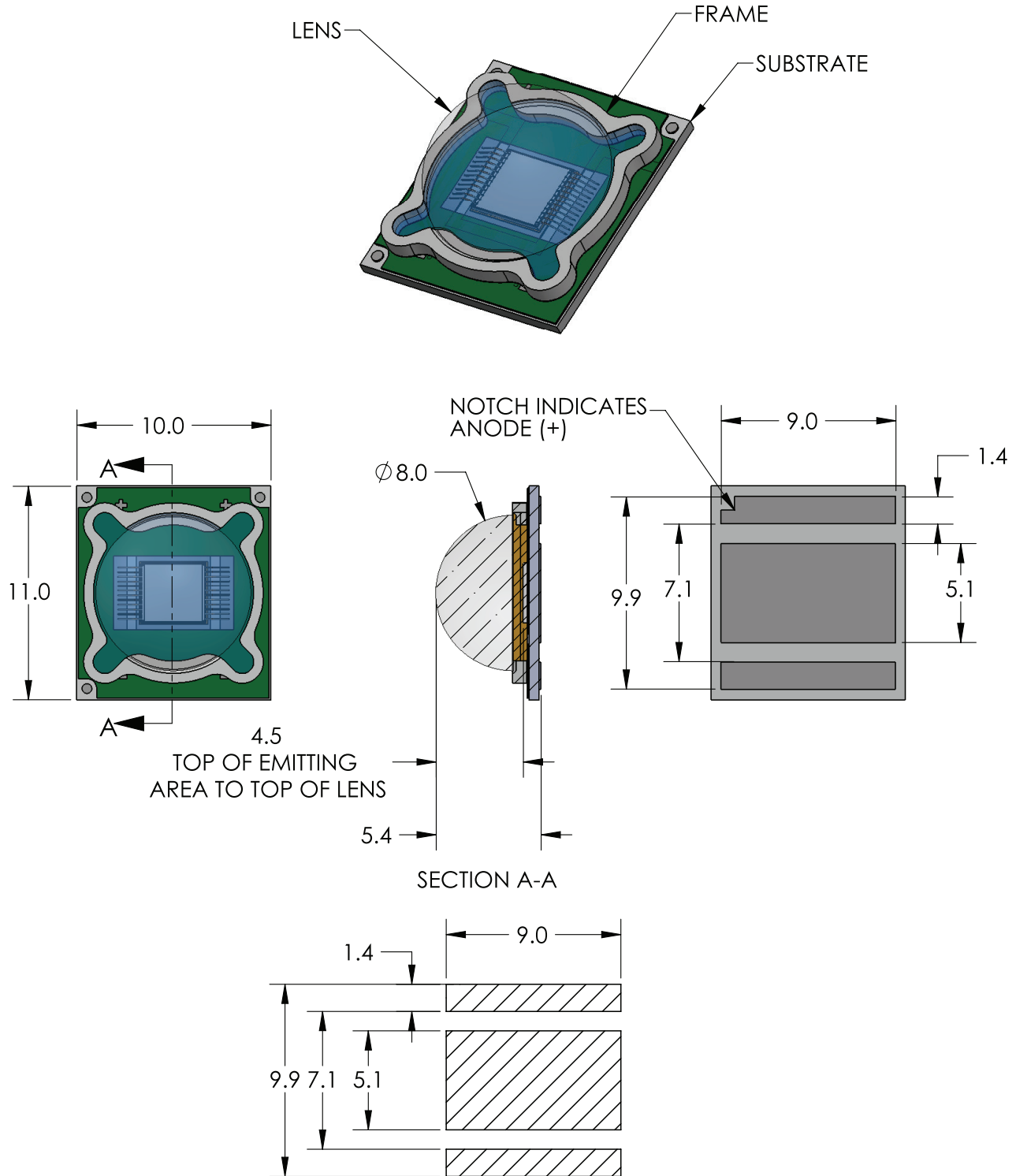

For detailed drawing please refer to DWG-001359 document

Mechanical Dimensions – SST-90 Star Board

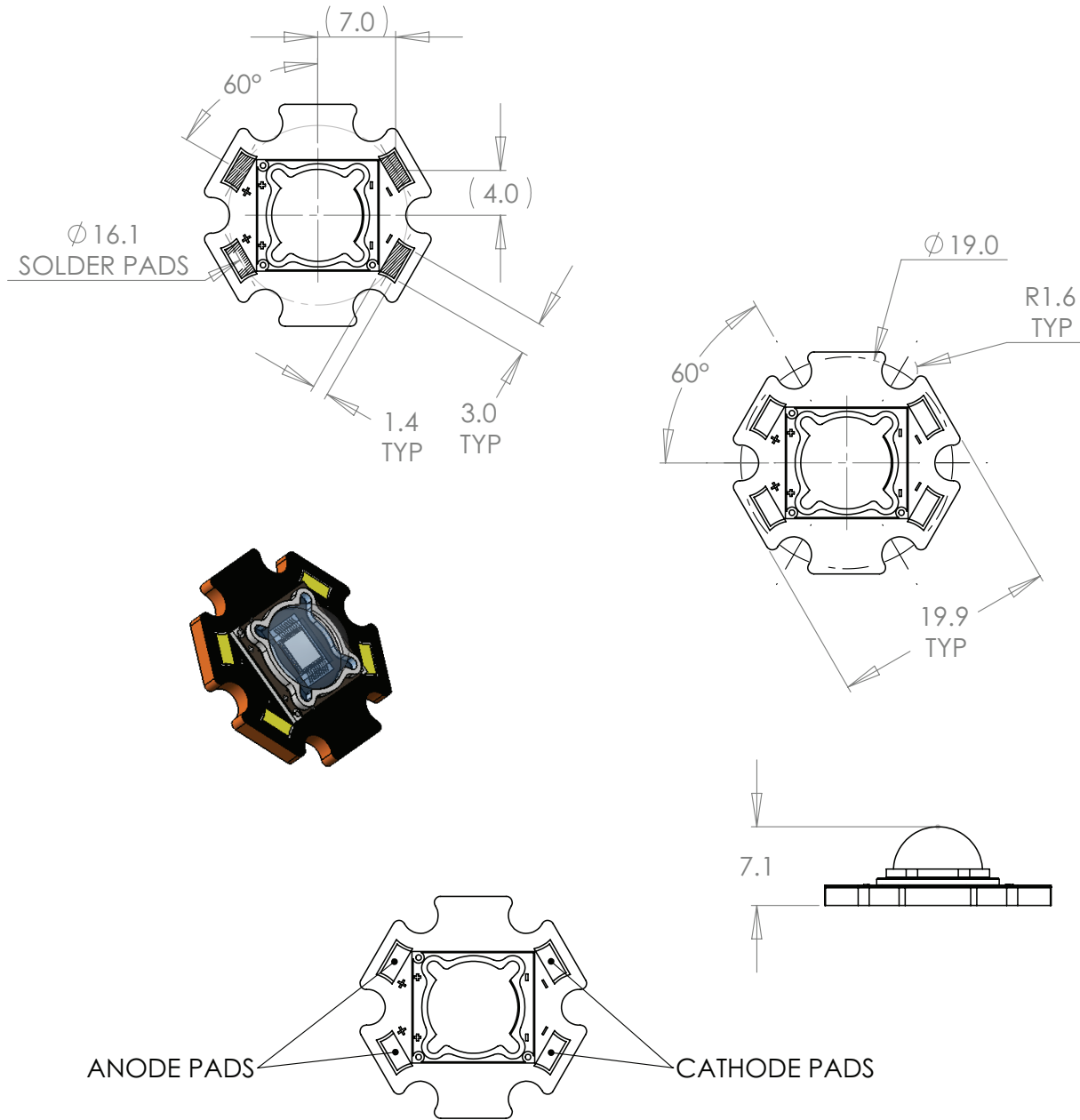

Note 1: Recommended mounting screw: M3 or #4

Note 2: All dimensions in millimeters

Note 3: All anode pads on board are interconnected. All cathode pads on board are interconnected

Solder Profile

SAC 305 Reflow Profile Window For Low Density Boards

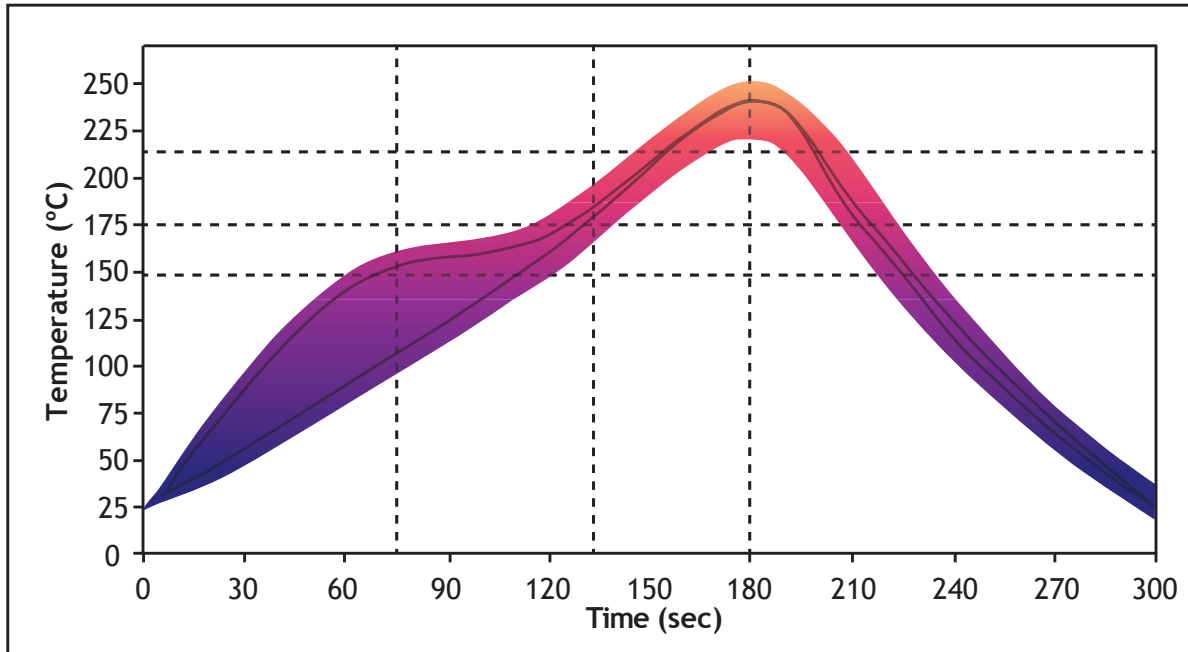

Lead free solder guideline for low density boards

| Solder Profile Stage | Lead-Free Solder | Lead-based Solder |
|------------------------------------|--------------------|--------------------|
| Profile length, Ambient to Peak | 2.75 - 3.5 minutes | 2.75 - 3.5 minutes |
| Time Maintained Above: Temperature | 217 °C | 183 °C |
| Time Maintained Above: Time | 30 - 60 seconds | 30 - 60 seconds |
| Cooldown Rate | ≤4° C/sec | ≤4° C/sec |
| Cooldown Duration | 45 ± 15 sec | 45 ± 15 sec |

Note 1: Temperatures are taken and monitored at the component copper layer.

Note 2: Optimum profile may differ due to oven type, circuit board or assembly layout.

Note 3: Recommended lead free, no-clean solder: AIM NC254-SAC305.

Note 4: Refer to APN-001473 soldering and handling application note for additional solder profiles and details.

Note 5: MSL- Level 2A

Tape and Reel Drawing

DIMENSIONS ARE IN mm. (INCH)

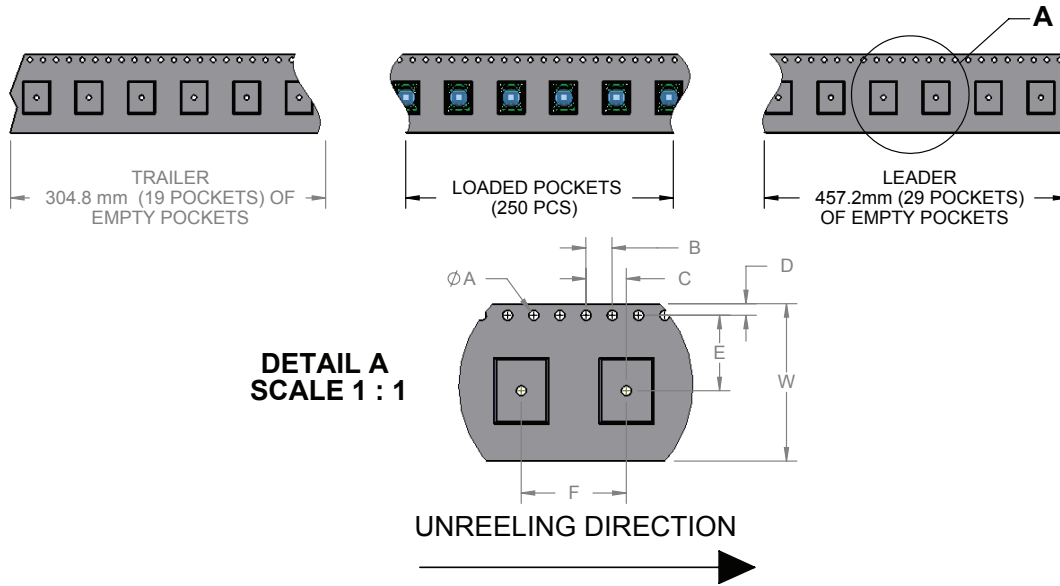

| TAPE DIMENSIONS | | | | | | | |
|-----------------|------------|------------|------------|------------|-------------|-------------|--|
| W | ϕA | B | C | D | E | F | |
| 24.0 (.945) | 1.5 (.059) | 3.9 (.157) | 6.1 (.241) | 1.7 (.069) | 11.5 (.453) | 16.0 (.630) | |

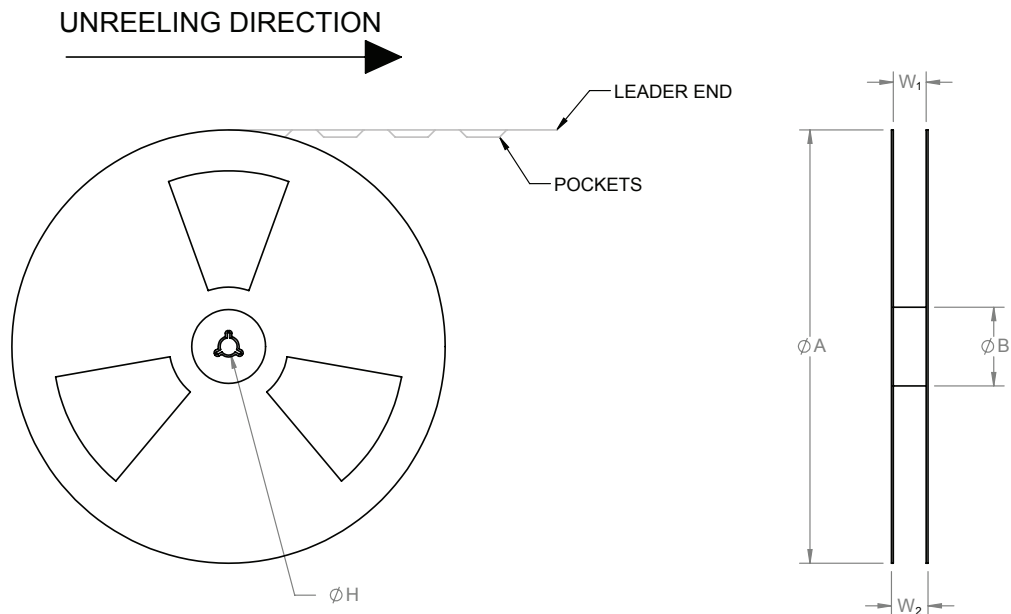

| REEL DIMENSIONS | | | | |
|-----------------|-------|-------|----------|----------|
| ϕA | W_1 | W_2 | ϕB | ϕH |

Ordering Information

| Ordering Part Number ^{1,2} | Color | Description |
|-------------------------------------|----------------------------|--|
| SST-90-WDLS-F11-N2150 | 6500K White 5700K White | White Big Chip LED™ SST-90 surface mount device consisting of a 9mm ² LED on ceramic substrate, tray pack |
| SST-90-WCLS-F11-GN450 | 4500K White 4000K White | |
| SST-90-WWRM-F11-GM750 | 3000K White 2700K White | |
| SSR-90-WDLS-R11-N2150 | 6500K White 5700K White | SSR-90 evaluation module consisting of a SST-90 surface mount device mounted on an aluminum star board |
| SSR-90-WCLS-R11-GN450 | 4500K White 4000K White | |
| SSR-90-WWRM-R11-GM750 | 3000K White 2700K White | |

Note 1: N2150 - denotes a bin kit comprising of all flux and chromaticity bins at the 6500K and 5700K color points

GN450 - denotes a bin kit comprising of all flux and chromaticity bins at the 4500K and 4000K color points

GM750 - denotes a bin kit comprising of all flux and chromaticity bins at the 3000K and 2700K color points

Ordering Information

| Ordering Part Number ^{1,2,3} | Color | Description |
|---------------------------------------|-------|--|
| SST-90-R-F11-HH100 | Red | Red SST-90 consisting of a 9 mm ² LED on a surface mount substrate |
| SST-90-G-F11-JG200 | Green | Green SST-90 consisting of a 9 mm ² LED on a surface mount substrate |
| SST-90-B-F11-KF300 | Blue | Blue SST-90 consisting of a 9 mm ² LED on a surface mount substrate |
| SSR-90-R-R11-HH100 | Red | Red SSR-90 evaluation module consisting of a SST-90 surface mount device mounted on an aluminum star board |
| SSR-90-G-R11-JG200 | Green | Green SSR-90 evaluation module consisting of a SST-90 surface mount device mounted on an aluminum star board |
| SSR-90-B-R11-KF300 | Blue | Blue SSR-90 evaluation module consisting of a SST-90 surface mount device mounted on an aluminum star board |

Note 1: *HH100 - denotes a bin kit comprising of all red flux and wavelength bins as specified on page 5*
JG200 - denotes a bin kit comprising of all green flux and wavelength bins as specified on page 5
KF300 - denotes a bin kit comprising of all blue flux and wavelength bins as specified on page 5

Note 2: *For ordering information on all available bin kits, please see PDS-001692: SST-90 Binning & Labeling document*

The products, their specifications and other information appearing in this document are subject to change by Luminus Devices without notice. Luminus Devices assumes no liability for errors that may appear in this document, and no liability otherwise arising from the application or use of the product or information contained herein. None of the information provided herein should be considered to be a representation of the fitness or suitability of the product for any particular application or as any other form of warranty. Luminus Devices’ product warranties are limited to only such warranties as accompany a purchase contract or purchase order for such products. Nothing herein is to be construed as constituting an additional warranty. No information contained in this publication may be considered as a waiver by Luminus Devices of any intellectual property rights that Luminus Devices may have in such information. Big Chip LEDs™ is a registered trademark of Luminus Devices, Inc., all rights reserved.

This product is protected by U.S. Patents 6,831,302; 7,074,631; 7,083,993; 7,084,434; 7,098,589; 7,105,861; 7,138,666; 7,166,870; 7,166,871; 7,170,100; 7,196,354; 7,211,831; 7,262,550; 7,274,043; 7,301,271; 7,341,880; 7,344,903; 7,345,416; 7,348,603; 7,388,233; 7,391,059 Patents Pending in the U.S. and other countries.