

## PROTECTION PRODUCTS

### Description

P Clamp TVS diodes are designed for use in harsh transient environments to protect sensitive electronics from damage or latch-up due to EOS, lightning, CDE, and ESD. They feature large cross-sectional area junctions for conducting high transient currents. These devices offer desirable characteristics for board level protection including fast response time, low operating and clamping voltage, and no device degradation.

The P Clamp0511ZV features excellent protection characteristics highlighted by high surge current capability (115A,  $t_p = 8/20\mu s$ ), low peak ESD clamping voltage, and high ESD withstand voltage ( $\pm 30kV$  per IEC 61000-4-2). Each device will protect one power line operating at 5V.

P Clamp0511ZV is in a 2-pin DFN package, measuring 1.0 x 0.6 x 0.25mm. Leads are spaced at a pitch of 0.65mm and are finished with lead-free NiAu. Each device can protect one bi-directional line operating at  $\pm 5$  volts. They may be used to meet the ESD immunity requirements of IEC 61000-4-2, Level 4 ( $\pm 30kV$  air,  $\pm 30kV$  contact discharge). The combination of small size and high ESD and surge capability makes them ideal for use in applications such as cellular phones, battery protection, and VBUS protection.

### Package Dimension

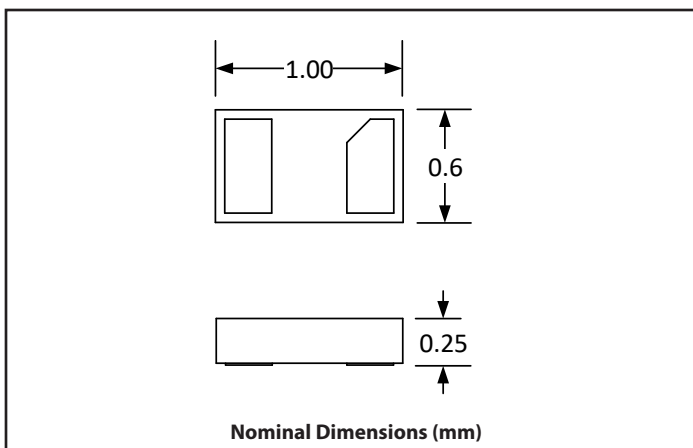

### Features

- High ESD withstand Voltage:  $\pm 30kV$  (Contact) and  $\pm 30kV$  (Air) per IEC 61000-4-2
- High peak pulse current capability: 115A ( $t_p = 8/20\mu s$ )
- Small package size (1.0 x 0.6 x 0.25mm)
- Protects one power line
- Low ESD clamping voltage
- Working voltage:  $\pm 5.0V$
- Solid-state silicon-avalanche technology

### Mechanical Characteristics

- DFN 1.0 x 0.6 x 0.25mm package
- Pb-Free, Halogen Free, RoHS/WEEE Compliant
- Molding compound flammability rating: UL 94V-0
- Lead Finish: NiAu
- Marking: Marking code
- Packaging: Tape and Reel

### Applications

- Cellular Handsets & Accessories
- Industrial Equipment
- Voltage Supply Lines
- Battery protection
- USB VBus

### Schematic & Pin Configuration

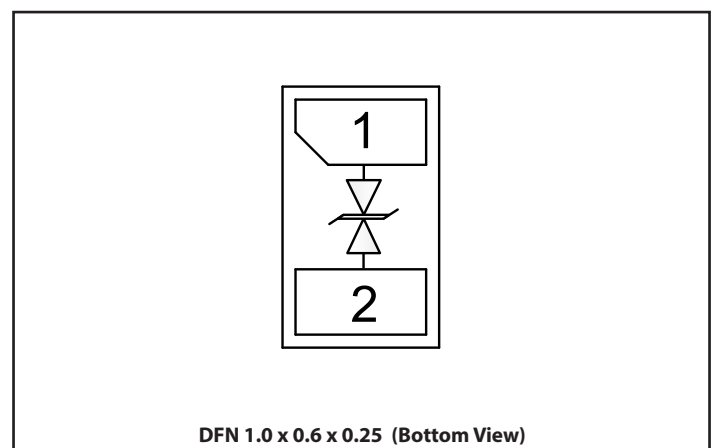

## Absolute Maximum Rating

Rating	Symbol	Value	Units
Peak Pulse Power ( $t_p = 8/20\mu s$ )	$P_{PK}$	1200	W
Peak Pulse Current ( $t_p = 8/20\mu s$ )	$I_{PP}$	115	A
ESD per IEC 61000-4-2 (Air) <sup>(1)</sup> ESD per IEC 61000-4-2 (Contact) <sup>(1)</sup>	$V_{ESD}$	$\pm 30$ $\pm 30$	kV
Operating Temperature	$T_{OP}$	-55 to +125	°C
Junction Temperature & Storage Temperature	$T_J$ & $T_{STG}$	-55 to +150	°C

## Electrical Characteristics (T=25°C unless otherwise specified)

Parameter	Symbol	Conditions	Min.	Typ.	Max.	Units
Reverse Stand-Off Voltage	$V_{RWM}$	Pin 1 to 2 or Pin 2 to 1			5	V
Reverse Breakdown Voltage	$V_{BR}$	$I_t = 1mA$ , Pin 1 to 2 or Pin 2 to 1	6	7	8	V
Reverse Leakage Current	$I_R$	$V_{RWM} = 5V$ , Pin 1 to 2 or Pin 2 to 1		0.004	0.1	$\mu A$
Clamping Voltage	$V_C$	$t_p = 8/20\mu s$	$I_{PP} = 40A$	7.3	8.5	V
			$I_{PP} = 80A$	8.1	9.5	
			$I_{PP} = 115A$	9	10.5	
ESD Clamping Voltage <sup>2</sup>	$V_C$	$tp = 0.2/100ns$	$I_{TLP} = 4A$	7		V
			$I_{TLP} = 16A$	6.9		
Dynamic Resistance <sup>2,3</sup>	$R_{DYN}$	$tp = 0.2/100ns$		0.02		$\Omega$
Junction Capacitance	$C_J$	$V_R = 0V$ , $f = 1MHz$		200	275	pF

Notes:

- 1) ESD gun return path connected to ESD ground plane.
- 2) Transmission Line Pulse Test (TLP) Settings:  $t_p = 100ns$ ,  $t_r = 0.2ns$ ,  $I_{TLP}$  and  $V_{TLP}$  averaging window:  $t_1 = 70ns$  to  $t_2 = 90ns$ .
- 3) Dynamic resistance calculated from  $I_{TLP} = 4A$  to  $I_{TLP} = 16A$

# Typical Characteristics

ESD Clamping (+8kV Contact per IEC 61000-4-2)

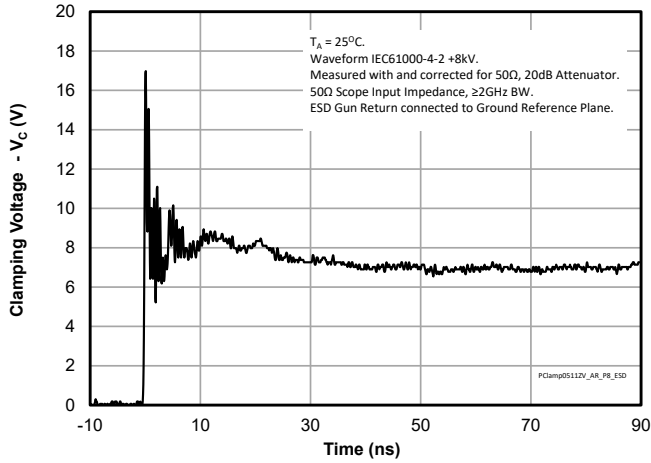

ESD Clamping (-8kV Contact per IEC 61000-4-2)

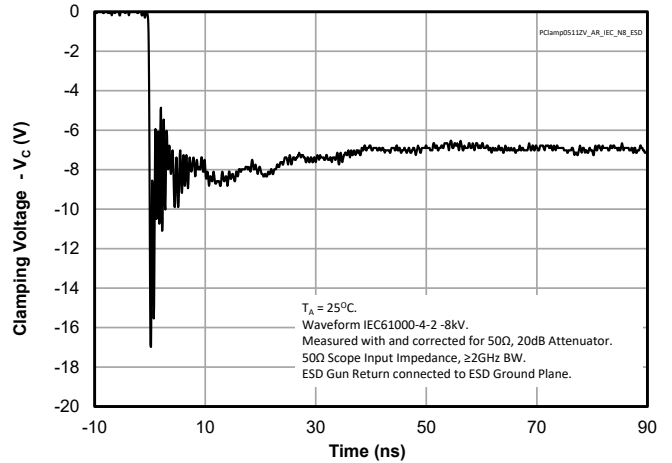

TLP Characteristic (Positive Pulse)

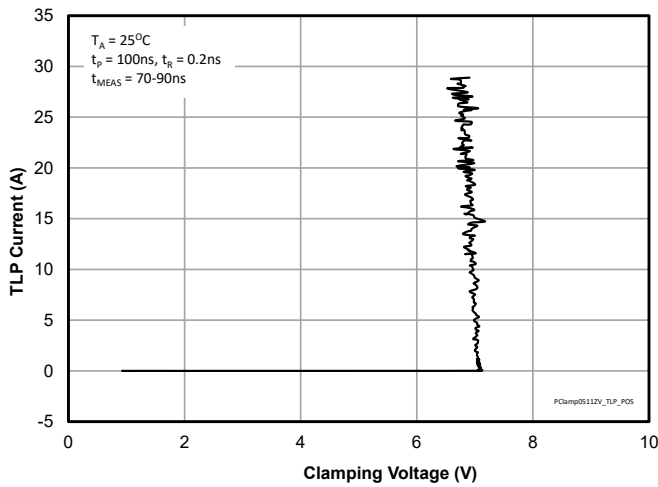

TLP Characteristic (Negative Pulse)

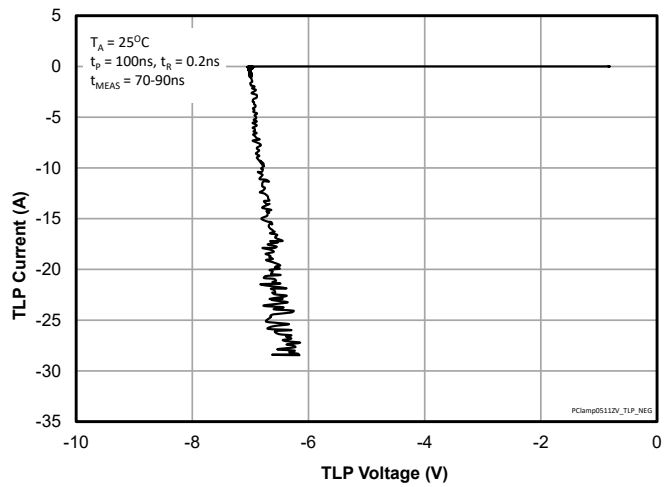

Clamping Voltage vs. Peak Pulse Current ( $t_p = 8/20\mu s$ )

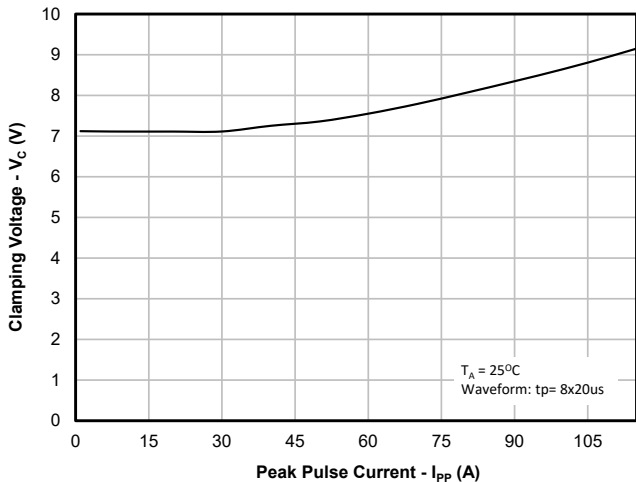

Capacitance vs. Reverse Voltage

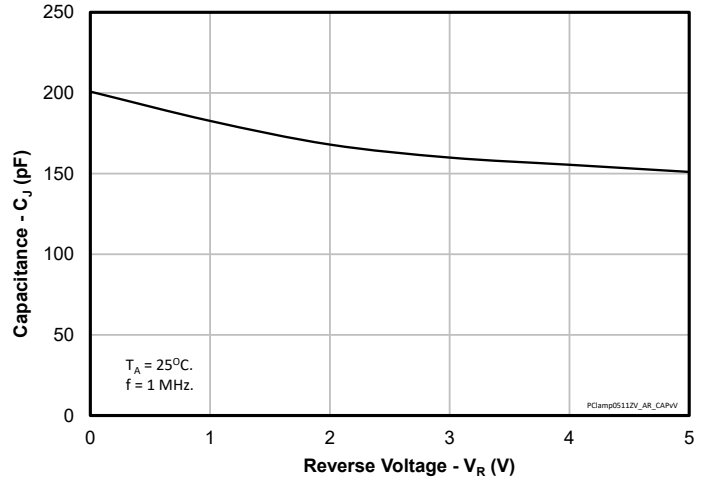

# Application Information

## Assembly Guidelines

The small size of this device means that some care must be taken during the mounting process to insure reliable solder joints. The figure at the right details Semtech's recommended mounting pattern. Recommended assembly guidelines are shown in Table 1. Note that these are only recommendations and should serve only as a starting point for design since there are many factors that affect the assembly process. Exact manufacturing parameters will require some experimentation to get the desired solder application.

## Solder Stencil

Stencil design is one of the key factors which will determine the volume of solder paste which is deposited onto the land pad. The area ratio of the stencil aperture will determine how well the stencil will print. The area ratio takes into account the aperture shape, aperture size, and stencil thickness. A minimum area ratio of 0.66 is preferred for the subject package. The area ratio of a rectangular aperture is given as:

$$\text{Area Ratio} = (L * W) / (2 * (L + W) * T)$$

Where:

L = Aperture Length

W = Aperture Width

T = Stencil Thickness

Semtech recommends a stencil with square aperture and rounded corners for consistent solder release. The stencil should be laser cut with electro-polished finish. A stencil thickness of 0.100mm (0.004") or 0.125mm (0.005") stencil may be used, however the stencil opening may need to be increased slightly to achieve the desired area ratio to ensure proper solder coverage on the pad.

## Recommended Mounting Pattern

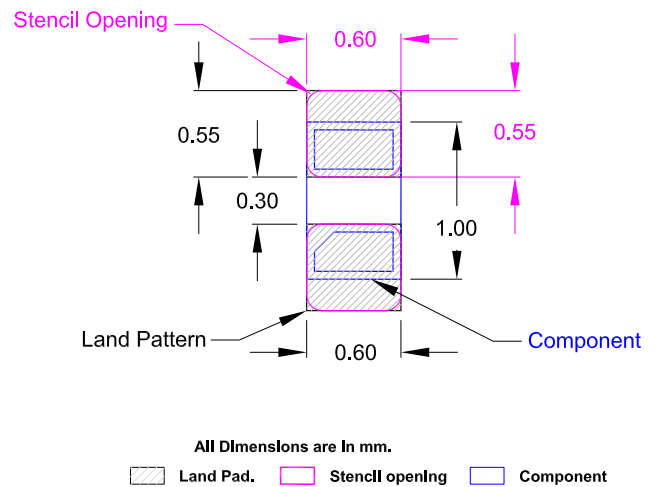

**Table 1 - Assembly Guidelines**

Assembly Parameter	Recommendation
Solder Stencil Design	Laser Cut, Electro-Polished
Aperture Shape	Rectangular with Rounded Corners
Solder Stencil Thickness	0.100mm (0.004") or 0.125mm (0.005")
Solder Paste Type	Type 4 or Type 5
Solder Reflow Profile	Per JEDEC J-STD-020
PCB Solder Pad Design	SMD or NSMD
PCB Pad Finish	OSP or NiAu

# Outline Drawing - DFN 1.0 x 0.6 x 0.25mm 2 Lead

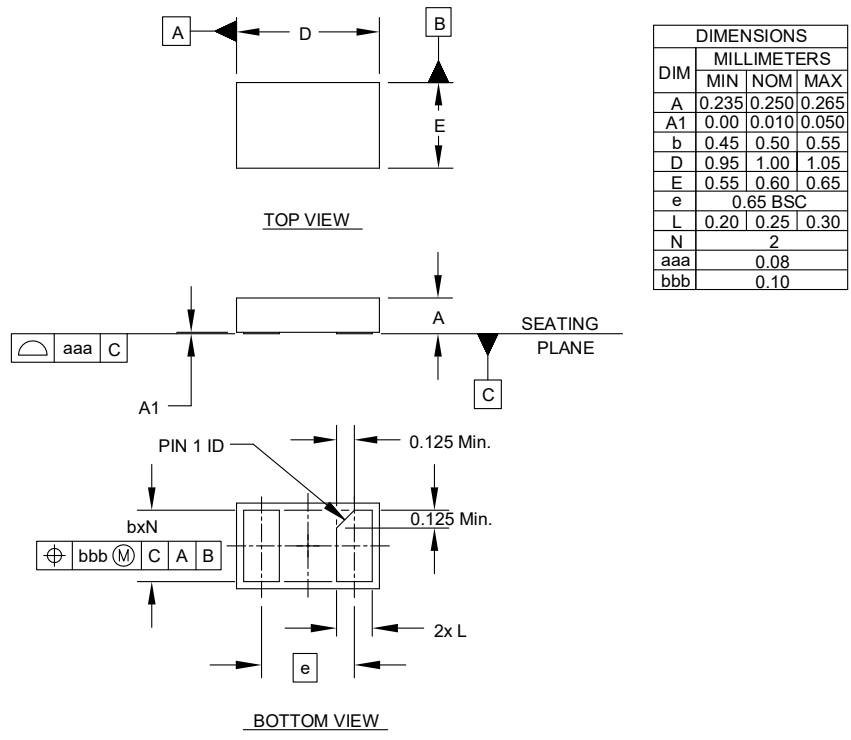

NOTES:  
 1. CONTROLLING DIMENSIONS ARE IN MILLIMETERS (ANGLES IN DEGREES).

# Land Pattern - DFN 1.0 x 0.6 x 0.25mm 2 Lead

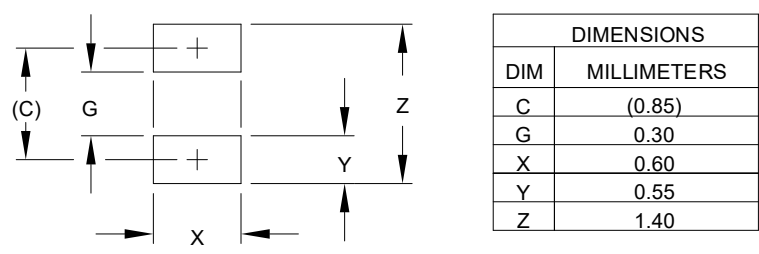

NOTES:  
 1. CONTROLLING DIMENSIONS ARE IN MILLIMETERS (ANGLES IN DEGREES).  
 2. THIS LAND PATTERN IS FOR REFERENCE PURPOSES ONLY.  
 CONSULT YOUR MANUFACTURING GROUP TO ENSURE YOUR COMPANY'S MANUFACTURING GUIDELINES ARE MET.

# Marking Code

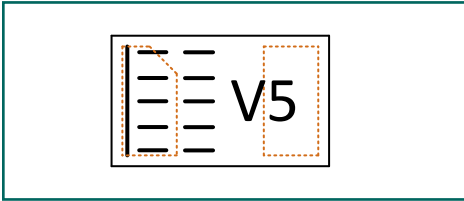

Notes:

1. Marking will also include line matrix date code.
2. Bar indicates Pin 1 location.

# Tape and Reel Specification

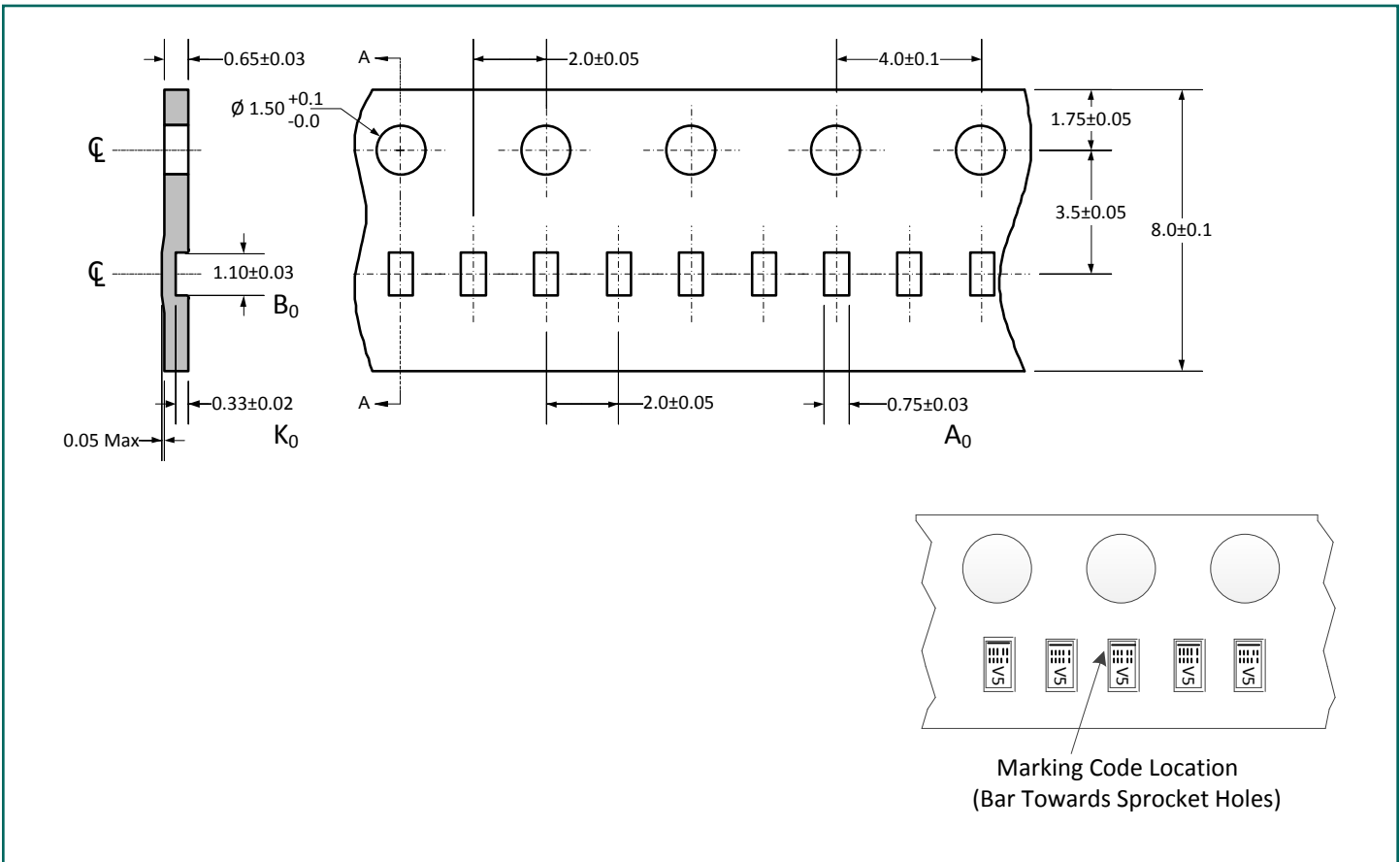

# Ordering Information

Part Number	Qty per Reel	Reel Size
PCLamp0511ZVTFT	15,000	7"



---

## Important Notice

Information relating to this product and the application or design described herein is believed to be reliable, however such information is provided as a guide only and Semtech assumes no liability for any errors in this document, or for the application or design described herein. Semtech reserves the right to make changes to the product or this document at any time without notice. Buyers should obtain the latest relevant information before placing orders and should verify that such information is current and complete. Semtech warrants performance of its products to the specifications applicable at the time of sale, and all sales are made in accordance with Semtech's standard terms and conditions of sale.

SEMTECH PRODUCTS ARE NOT DESIGNED, INTENDED, AUTHORIZED OR WARRANTED TO BE SUITABLE FOR USE IN LIFE-SUPPORT APPLICATIONS, DEVICES OR SYSTEMS, OR IN NUCLEAR APPLICATIONS IN WHICH THE FAILURE COULD BE REASONABLY EXPECTED TO RESULT IN PERSONAL INJURY, LOSS OF LIFE OR SEVERE PROPERTY OR ENVIRONMENTAL DAMAGE. INCLUSION OF SEMTECH PRODUCTS IN SUCH APPLICATIONS IS UNDERSTOOD TO BE UNDERTAKEN SOLELY AT THE CUSTOMER'S OWN RISK. Should a customer purchase or use Semtech products for any such unauthorized application, the customer shall indemnify and hold Semtech and its officers, employees, subsidiaries, affiliates, and distributors harmless against all claims, costs damages and attorney fees which could arise.

The Semtech name and logo are registered trademarks of the Semtech Corporation. All other trademarks and trade names mentioned may be marks and names of Semtech or their respective companies. Semtech reserves the right to make changes to, or discontinue any products described in this document without further notice. Semtech makes no warranty, representation or guarantee, express or implied, regarding the suitability of its products for any particular purpose. All rights reserved.

© Semtech 2022

---

## Contact Information

**Semtech Corporation**  
200 Flynn Road, Camarillo, CA 93012  
Phone: (805) 498-2111, Fax: (805) 498-3804  
[www.semtech.com](http://www.semtech.com)