

Features

Switching Regulator

- Efficiency up to 91%, no need for heatsinks
- Pin-out compatible with LM78XX linears
- Low profile (L*W*H=11.6*8.5*10.4mm)
- Wide input range (7V - 28V)
- Short circuit protection
- IEC/EN60950-1 + AM2 certified



R-78E-1.0

1.0 Amp
SIP3
Single Output



Description

The R-78E series is a switching regulator module that has been designed to offer all the advantages of a switching regulator (high efficiency, wide input range, accurate output voltage regulation) but with a low cost for production quantities. Due to the R-78E's high efficiency of up to 91% at an output voltage of 5V/1A at the output, no heat sink is required. The compact TO-220 compatible SIP3 package measures only 11.6 x 8.5 x 10.4 mm, so it saves precious board space. The warranty is 3 years.

Selection Guide

Part Number	Input Voltage Range [VDC]	Output Voltage [VDC]	Output Current [A]	Efficiency ⁽¹⁾ typ @ min Vin. [%]	Max. Capacitive Load ⁽²⁾ [µF]
R-78E3.3-1.0	7 - 28	3.3	1.0	87	220
R-78E5.0-1.0	8 - 28	5.0	1.0	91	220

Notes:

Note1: Efficiency is tested at nom. input voltage and full load

Note2: Max. Cap Load is tested by nominal input and full resistive load

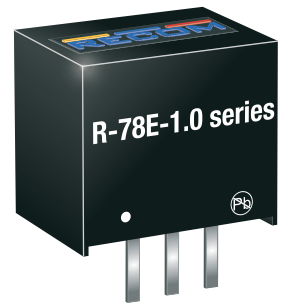

Model Numbering

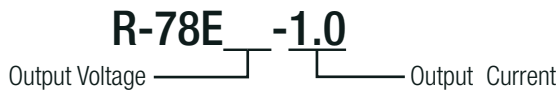

IEC60950-1 certified
EN60950-1 certified

Specifications (measured at Ta= 25°C, full load, nominal input voltage and after warm-up)

BASIC CHARACTERISTICS				
Parameter	Condition	Min.	Typ.	Max.
Input Voltage Range	nom. Vin = 24VDC	7VDC	24VDC	28VDC
Input Current	min. Vin			1000mA
Quiescent Current			1.5mA	
Internal Operating Frequency	Vin= 12VDC		330kHz	
Output Ripple and Noise ⁽³⁾	20MHz BW			120mVp-p

Notes:

Note3: Measurements are made with a 100nF MLCC across output (low ESR)

continued on next page

Specifications (measured at Ta= 25°C, full load, nominal input voltage and after warm-up)

Efficiency vs. Load

R-78E3.3-1.0

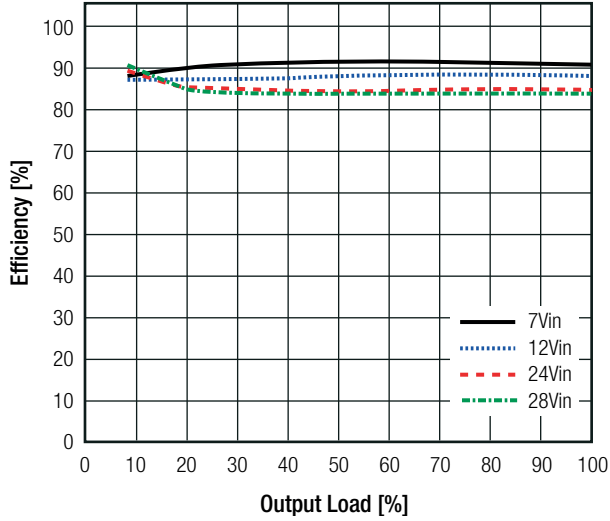

R-78E5.0-1.0

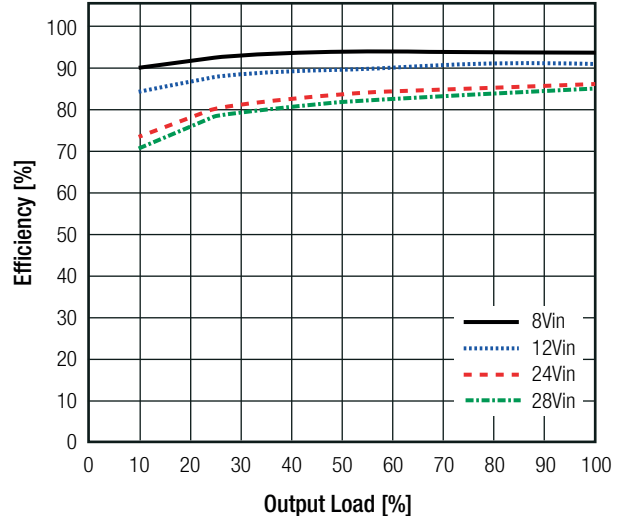

REGULATIONS

Parameter	Condition	Value
Output Accuracy		±3.0% typ. / ±5.0% max.
Line Regulation	low line to high line, full load	±1.0% max.
Load Regulation	typ Vin. and 10% to 100% load	±1.5% max.

PROTECTIONS

Parameter	Condition	Value
Short Circuit Protection (SCP)		automatic recovery
Over Current Protection (OCP)	100% = 1A	200% Load

ENVIRONMENTAL

Parameter	Condition	Value
Operating Temperature Range	natural convection and with derating (see graph)	-40°C to +85°C
Humidity	non-condensing	95%, RH max.
MTBF	according to MIL-HDBK-217F, G.B. +25°C	3875 x 10 ³ hours

Derating Graph

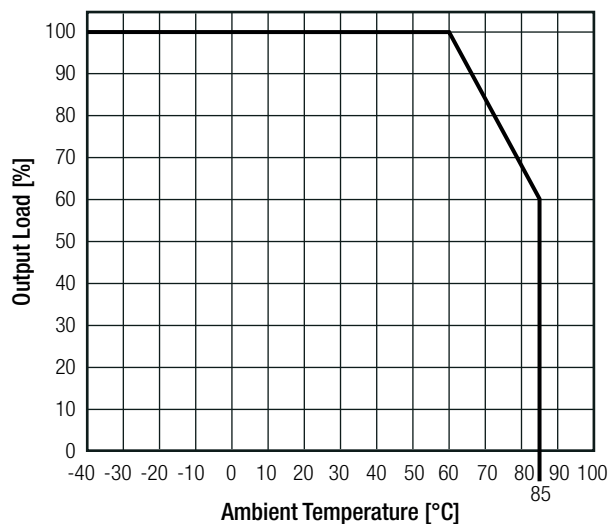

Specifications (measured at Ta= 25°C, full load, nominal input voltage and after warm-up)

SAFETY AND CERTIFICATIONS

Certificate Type (Safety)	Report / File Number	Standard
Information Technology Equipment, General Requirements for Safety	1603123	IEC60950-1:2005, 2nd Edition + AM 2:2013 EN60950-1:2006 + AM2:2013
EAC	RU-AT.49.09571	TP TC 004/2011
RoHS 2+		RoHS 2011/65/EU + AM2015/863

EMC Compliance

EMC Compliance	Condition	Standard / Criterion
Electromagnetic compatibility of multimedia equipment - Emission requirements	with external filter (see filter suggestion below)	EN55032, Class A and B

EMC Filter Suggestion according to EN55032

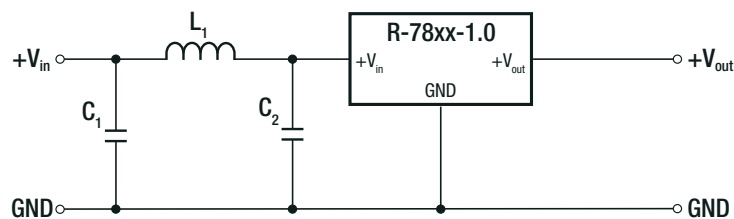

Component List Class A

MODEL	C1	C2	L1
R-78E3.3-1.0	10µF	10µF	12µH choke
R-78E5.0-1.0	100V MLCC	100V MLCC	RLS-126

Component List Class B

MODEL	C1	C2	L1
R-78E3.3-1.0	10µF	2.2µF	68µH choke
R-78E5.0-1.0	100V MLCC	100V MLCC	RLS-686

Notes:

Note4: Filter suggestions are valid for indicated part numbers only. For other part numbers, please contact RECOM tech support for advice

DIMENSION and PHYSICAL CHARACTERISTICS

Parameter	Condition	Value
Material	case potting	non-conductive black plastic, (UL94 V-0) silicone, (UL94 V-0)
Package Dimension (LxWxH)		11.6 x 8.5 x 10.4mm
Package Weight		2g typ.

Dimension Drawing (mm)

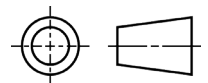
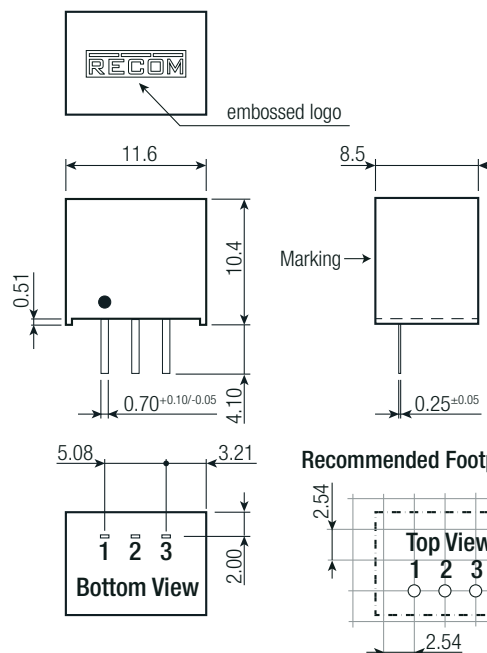

Pin Connections

Pin #	Function
1	+Vin
2	GND
3	+Vout

Tolerance: xx.x= ±0.50mm
xx.xx= ±0.25mm

Specifications (measured at Ta= 25°C, full load, nominal input voltage and after warm-up)

INSTALLATION AND APPLICATION

Standard Application

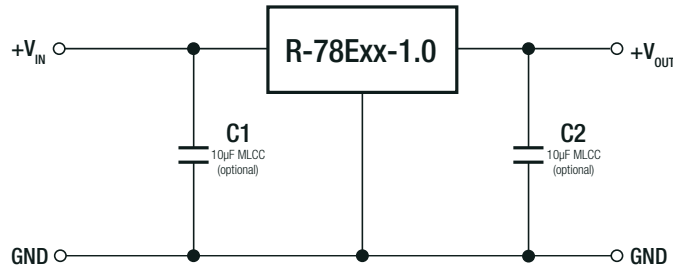

To protect the converter during power-up, use soft start power supply.

Notes:

Note5: The R-78Exx-1.0 can not be used as positive to negative converter

PACKAGING INFORMATION

Parameter	Type	Value
Packaging Dimension (LxWxH)	tube	520.0 x 11.2 x 18.2mm
Packaging Quantity		42pcs
Storage Temperature Range		-55°C to +125°C

The product information and specifications may be subject to changes even without prior written notice. The product has been designed for various applications; its suitability lies in the responsibility of each customer. The products are not authorized for use in safety-critical applications without RECOM's explicit written consent. A safety-critical application is an application where a failure may reasonably be expected to endanger or cause loss of life, inflict bodily harm or damage property. The applicant shall indemnify and hold harmless RECOM, its affiliated companies and its representatives against any damage claims in connection with the unauthorized use of RECOM products in such safety-critical applications.

Mouser Electronics

Authorized Distributor

Click to View Pricing, Inventory, Delivery & Lifecycle Information:

[RECOM:](#)

[R-78E5.0-1.0](#) [R-78E3.3-1.0](#)