

ISL3150E, ISL3152E, ISL3153E, ISL3155E, ISL3156E, ISL3158E

±16.5kV ESD, Large Output Swing, 5V, Full Fail-Safe, 1/8 Unit Load, RS-485/RS-422 Transceivers

FN6363
Rev.3.00
Aug 31, 2017

The ISL315xE are IEC61000 ESD protected, 5V powered transceivers that meet the RS-485 and RS-422 standards for balanced communication. Driver outputs and receiver inputs are protected against ±16.5kV ESD strikes without latch-up.

Transmitters in this family deliver exceptional differential output voltages (2.4V min), into the RS-485 required 54Ω load, for better noise immunity, or to allow up to eight 120Ω terminations in "star" topologies.

These devices have very low bus currents so they present a true "1/8 unit load" to the RS-485 bus. This allows up to 256 transceivers on the network without using repeaters.

Receiver (Rx) inputs feature a "Full Fail-Safe" design, which ensures a logic high Rx output if Rx inputs are floating, shorted, or on a terminated but undriven bus. Rx outputs feature high drive levels - typically 28mA at $V_{OL} = 1V$ (to ease the design of optocoupled isolated interfaces).

Half duplex (Rx inputs and Tx outputs multiplexed together) and full duplex pinouts are available. See [Table 1 on page 2](#) for key features and configurations by device number.

Related Literature

For a full list of related documents, visit our website

- [ISL3150E](#), [ISL3152E](#), [ISL3153E](#), [ISL3155E](#), [ISL3156E](#), and [ISL3158E](#) product pages

Features

- High driver V_{OD} 2.4V (Min) at $R_D = 54\Omega$
Better noise immunity, or drive up to eight terminations
- ±16.5kV IEC61000 ESD protection on I/O bus pins
- High transient overvoltage tolerance ±100V
- Full fail-safe (open, short, terminated) receivers
- High Rx I_{OL} for opto-couplers in isolated designs
- Hot plug circuitry - Tx and Rx outputs remain three-state during power-up and power-down
- True 1/8 unit load for up to 256 devices on the bus
- High data rates up to 20Mbps
- Low quiescent supply current 600μA
- Ultra low shutdown supply current. 70nA

Applications

- Utility meters/automated meter reading systems
- High node count systems
- PROFIBUS[®] and Fieldbus networks, and factory automation
- Security camera networks
- Building lighting and environmental control systems
- Industrial/process control networks

Exceptional Tx Drives Up To 8 Terminations While Still Delivering 1.5V V_{OD}

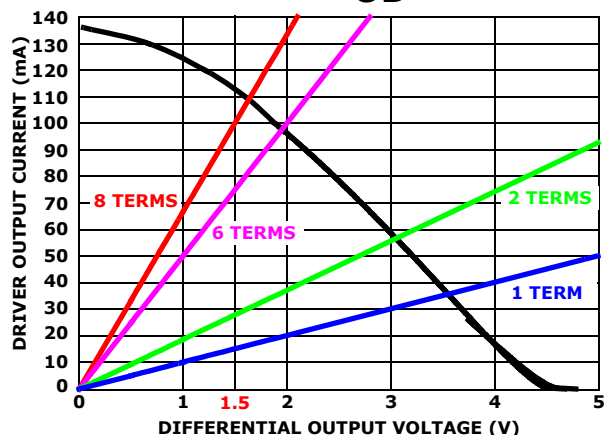

Large V_{OD} Delivers Superior Signal at Cable End for Enhanced Noise Immunity

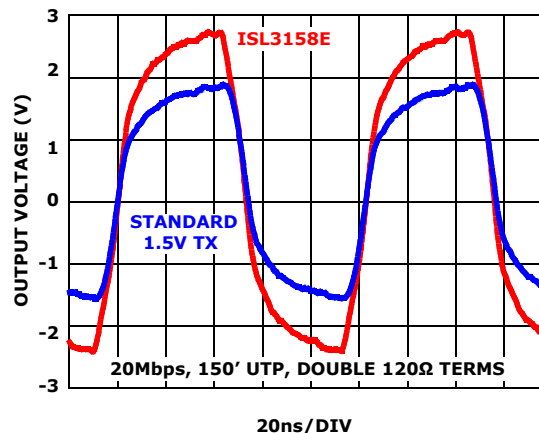

TABLE 1. SUMMARY OF FEATURES

PART NUMBER	HALF/FULL DUPLEX	DATA RATE (Mbps)	SLEW-RATE LIMITED?	HOT PLUG	# DEVICES ON BUS	Rx/Tx ENABLE?	QUIESCENT I _{CC} (μA)	LOW POWER SHUTDOWN?	PIN COUNT
ISL3150E	Full	0.115	Yes	Yes	256	Yes	600	Yes	10, 14
ISL3152E	Half	0.115	Yes	Yes	256	Yes	600	Yes	8
ISL3153E	Full	1	Yes	Yes	256	Yes	600	Yes	10, 14
ISL3155E	Half	1	Yes	Yes	256	Yes	600	Yes	8
ISL3156E	Full	20	No	Yes	256	Yes	600	Yes	10, 14
ISL3158E	Half	20	No	Yes	256	Yes	600	Yes	8

Ordering Information

PART NUMBER (Notes 6, 7)	PART MARKING	TEMP. RANGE (°C)	PACKAGE (RoHS-Compliant)	PKG. DWG. #
ISL3150EIBZ (Notes 2, 3)	3150EIBZ	-40 to +85	14 Ld SOIC	M14.15
ISL3150EIUZ (Notes 2, 3)	3150Z	-40 to +85	10 Ld MSOP	M10.118
ISL3152EIBZ (Notes 2, 3, 4)	3152EIBZ	-40 to +85	8 Ld SOIC	M8.15
ISL3152EIPZ	ISL3152 EIPZ	-40 to +85	8 Ld PDIP (Note 5)	E8.3
ISL3152EIUZ (Notes 2, 3)	3152Z	-40 to +85	8 Ld MSOP	M8.118
ISL3153EIBZ-T (Note 1)	3153EIBZ	-40 to +85	14 Ld SOIC	M14.15
ISL3153EIUZ (Notes 2, 3)	3153Z	-40 to +85	10 Ld MSOP	M10.118
ISL3155EIBZ (Notes 2, 3)	3155EIBZ	-40 to +85	8 Ld SOIC	M8.15
ISL3155EIUZ (Note 2)	3155Z	-40 to +85	8 Ld MSOP	M8.118
ISL3156EIBZ (Notes 2, 3)	3156EIBZ	-40 to +85	14 Ld SOIC	M14.15
ISL3156EIUZ (Notes 2, 3)	3156Z	-40 to +85	10 Ld MSOP	M10.118
ISL3158EIBZ (Notes 2, 3)	3158EIBZ	-40 to +85	8 Ld SOIC	M8.15
ISL3158EIUZ (Notes 2, 3)	3158Z	-40 to +85	8 Ld MSOP	M8.118

- 2.5k unit tape and reel option. Refer to [TB347](#) for details on reel specifications.
- Add "-T" suffix for 2.5k unit tape and reel options. Refer to [TB347](#) for details on reel specifications.
- Add "-T7A" suffix for 250 unit tape and reel options. Refer to [TB347](#) for details on reel specifications.
- Add "T7" suffix for 1k unit tape and reel options. Refer to [TB347](#) for details on reel specifications.
- Pb-free PDIPs can be used for through-hole wave solder processing only. They are not intended for use in Reflow solder processing applications.
- These Intersil Pb-free plastic packaged products employ special Pb-free material sets, molding compounds/die attach materials, and 100% matte tin plate plus anneal (e3 termination finish, which is RoHS compliant and compatible with both SnPb and Pb-free soldering operations). Intersil Pb-free products are MSL classified at Pb-free peak reflow temperatures that meet or exceed the Pb-free requirements of IPC/JEDEC J STD-020.
- For Moisture Sensitivity Level (MSL), see the product information pages for [ISL3150E](#), [ISL3152E](#), [ISL3153E](#), [ISL3155E](#), [ISL3156E](#), and [ISL3158E](#). For more information on MSL, see [TB363](#).

Pin Configurations

ISL3152E, ISL3155E, ISL3158E
(8 LD MSOP, 8 LD SOIC, 8 LD PDIP)

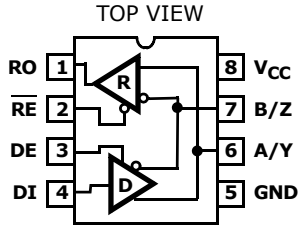

ISL3150E, ISL3153E, ISL3156E
(10 LD MSOP)

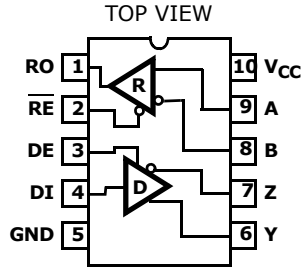

ISL3150E, ISL3153E, ISL3156E
(14 LD SOIC)

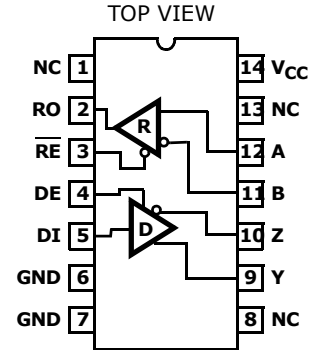

Pin Descriptions

PIN	FUNCTION
RO	Receiver output: If $A-B \geq -50\text{mV}$, RO is high; If $A-B \leq -200\text{mV}$, RO is low; RO = High if A and B are unconnected (floating) or shorted.
$\overline{\text{RE}}$	Receiver output enable. RO is enabled when $\overline{\text{RE}}$ is low; RO is high impedance when $\overline{\text{RE}}$ is high.
DE	Driver output enable. The driver outputs, Y and Z, are enabled by bringing DE high. They are high impedance when DE is low.
DI	Driver input. A low on DI forces output Y low and output Z high. Similarly, a high on DI forces output Y high and output Z low.
GND	Ground connection.
A/Y	$\pm 16.5\text{kV}$ IEC61000 ESD Protected RS-485/RS-422 level, non-inverting receiver input and non inverting driver output. Pin is an input if DE = 0; pin is an output if DE = 1.
B/Z	$\pm 16.5\text{kV}$ IEC61000 ESD Protected RS-485/RS-422 level, inverting receiver input and inverting driver output. Pin is an input if DE = 0; pin is an output if DE = 1.
A	$\pm 16.5\text{kV}$ IEC61000 ESD Protected RS-485/RS-422 level, non-inverting receiver input.
B	$\pm 16.5\text{kV}$ IEC61000 ESD Protected RS-485/RS-422 level, inverting receiver input.
Y	$\pm 16.5\text{kV}$ IEC61000 ESD Protected RS-485/RS-422 level, non-inverting driver output.
Z	$\pm 16.5\text{kV}$ IEC61000 ESD Protected RS-485/RS-422 level, inverting driver output.
V _{CC}	System power supply input (4.5V to 5.5V).
NC	No Connection.

Truth Tables

TRANSMITTING				
INPUTS			OUTPUTS	
$\overline{\text{RE}}$	DE	DI	Z	Y
X	1	1	0	1
X	1	0	1	0
0	0	X	High-Z	High-Z
1	0	X	High-Z*	High-Z*

NOTE: *Shutdown Mode (see [Note 14](#)).

RECEIVING				
INPUTS				OUTPUTS
$\overline{\text{RE}}$	DE Half Duplex	DE Full Duplex	A-B	RO
0	0	X	$V_{AB} \geq -0.05\text{V}$	1
0	0	X	$-0.05\text{V} > V_{AB} > -0.2\text{V}$	Undetermined
0	0	X	$V_{AB} \leq -0.2\text{V}$	0
0	0	X	Inputs Open/Shorted	1
1	0	X	X	High-Z*
1	1	X	X	High-Z

NOTE: *Shutdown Mode (see [Note 14](#)).

Typical Operating Circuit

ISL3152E, ISL3155E, ISL3158E

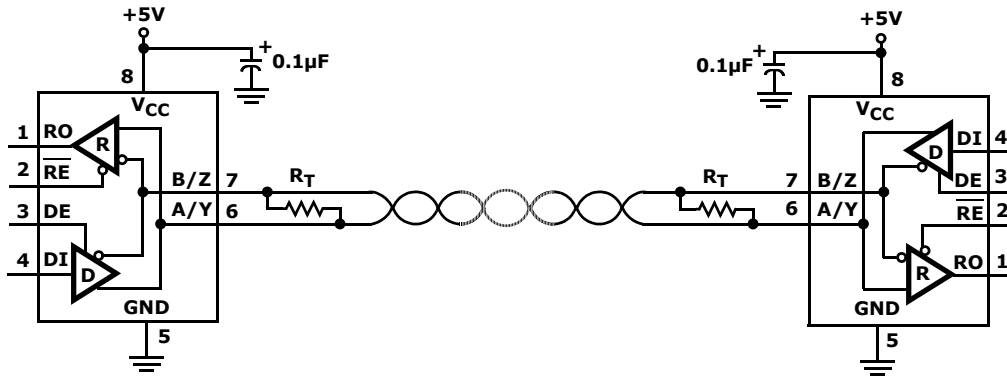

ISL3150E, ISL3153E, ISL3156E (SOIC PIN NUMBERS SHOWN)

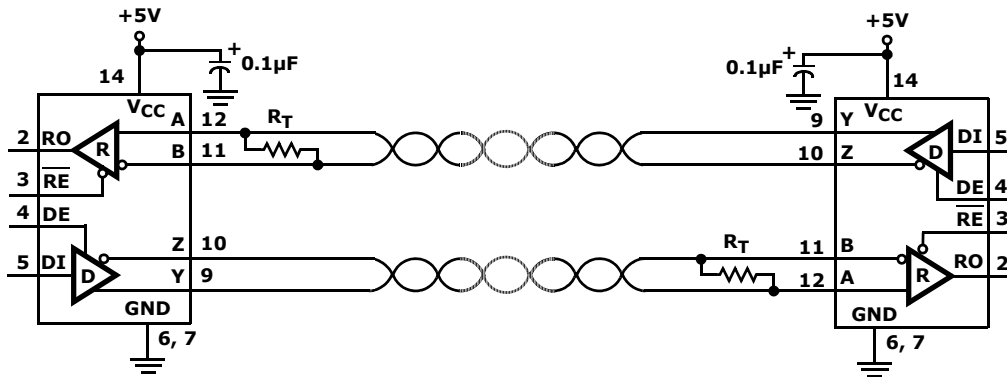

Absolute Maximum Ratings

V _{CC} to Ground	7V
Input Voltages	
DI, DE, \overline{RE}	-0.3V to (V _{CC} + 0.3V)
Input/Output Voltages	
A/Y, B/Z, A, B, Y, Z	-9V to +13V
A/Y, B/Z, A, B, Y, Z (Transient Pulse Through 100Ω, Note 19)	±100V
RO	-0.3V to (V _{CC} + 0.3V)
Short Circuit Duration	
Y, Z	Continuous
ESD Rating	See Specification Table

Thermal Information

Thermal Resistance (Typical, Note 8)	θ_{JA} (°C/W)
8 Ld SOIC	105
8 Ld MSOP, PDIP*	140
10 Ld MSOP	130
14 Ld SOIC	130
Maximum Junction Temperature (Plastic Package)	+150°C
Maximum Storage Temperature Range	-65°C to +150°C
Pb-Free Reflow Profile	see TB493
*Pb-free PDIPs can be used for through-hole wave solder processing only. They are not intended for use in Reflow solder processing applications.	

Recommended Operating Conditions

Supply Voltage	5V
Temperature Range	-40°C to +85°C
Bus Pin Common Mode Voltage Range	-7V to +12V

CAUTION: Do not operate at or near the maximum ratings listed for extended periods of time. Exposure to such conditions may adversely impact product reliability and result in failures not covered by warranty.

NOTE:

- 8. θ_{JA} is measured with the component mounted on a high-effective thermal conductivity test board in free air. See [TB379](#) for details.

Electrical Specifications Test Conditions: V_{CC} = 4.5V to 5.5V; Unless Otherwise Specified. Typicals are at V_{CC} = 5V, T_A = +25°C ([Note 9](#)). **Boldface limits apply across the operating temperature range, -40°C to +85°C.**

PARAMETER	SYMBOL	TEST CONDITIONS	TEMP (°C)	MIN (Note 17)	TYP	MAX (Note 17)	UNIT	
DC CHARACTERISTICS								
Driver Differential V _{OUT} (No load)	V _{OD1}		Full	-	-	V_{CC}	V	
Driver Differential V _{OUT} (Loaded)	V _{OD2}	R _L = 100Ω (RS-422) (Figure 1A)	Full	2.8	3.6	-	V	
		R _L = 54Ω (RS-485) (Figure 1A)	Full	2.4	3.1	V_{CC}	V	
		R _L = 15Ω (Eight 120Ω terminations) (Note 18)	25	-	1.65	-	V	
		R _L = 60Ω, -7V ≤ V _{CM} ≤ 12V (Figure 1B)	Full	2.4	3	-	V	
Change in Magnitude of Driver Differential V _{OUT} for Complementary Output States	ΔV _{OD}	R _L = 54Ω or 100Ω (Figure 1A)	Full	-	0.01	0.2	V	
Driver Common-Mode V _{OUT}	V _{OC}	R _L = 54Ω or 100Ω (Figure 1A)	Full	-	-	3.15	V	
Change in Magnitude of Driver Common-Mode V _{OUT} for Complementary Output States	ΔV _{OC}	R _L = 54Ω or 100Ω (Figure 1A)	Full	-	0.01	0.2	V	
Logic Input High Voltage	V _{IH}	DE, DI, \overline{RE}	Full	2	-	-	V	
Logic Input Low Voltage	V _{IL}	DE, DI, \overline{RE}	Full	-	-	0.8	V	
DI Input Hysteresis Voltage	V _{HYS}		25	-	100	-	mV	
Logic Input Current	I _{IN1}	DE, DI, \overline{RE}	Full	-2	-	2	μA	
Input Current (A, B, A/Y, B/Z)	I _{IN2}	DE = 0V, V _{CC} = 0V or 5.5V	V _{IN} = 12V	Full	-	70	125	μA
			V _{IN} = -7V	Full	-75	55	-	μA

Electrical Specifications Test Conditions: $V_{CC} = 4.5V$ to $5.5V$; Unless Otherwise Specified. Typicals are at $V_{CC} = 5V$, $T_A = +25^\circ C$ (Note 9). **Boldface limits apply across the operating temperature range, $-40^\circ C$ to $+85^\circ C$.** (Continued)

PARAMETER	SYMBOL	TEST CONDITIONS	TEMP (°C)	MIN (Note 17)	TYP	MAX (Note 17)	UNIT	
Output Leakage Current (Y, Z) (Full Duplex Versions Only)	I_{IN3}	$\overline{RE} = 0V$, $DE = 0V$, $V_{CC} = 0V$ or $5.5V$	$V_{IN} = 12V$	Full	-	1	40	μA
			$V_{IN} = -7V$	Full	-40	-9	-	μA
Output Leakage Current (Y, Z) in Shutdown Mode (Full Duplex)	I_{IN4}	$\overline{RE} = V_{CC}$, $DE = 0V$, $V_{CC} = 0V$ or $5.5V$	$V_{IN} = 12V$	Full	-	1	20	μA
			$V_{IN} = -7V$	Full	-20	-9	-	μA
Driver Short-Circuit Current, $V_O =$ High or Low	I_{OSD1}	$DE = V_{CC}$, $-7V \leq V_Y$ or $V_Z \leq 12V$ (Note 11)	Full	-	-	± 250	mA	
Receiver Differential Threshold Voltage	V_{TH}	$-7V \leq V_{CM} \leq 12V$	Full	-200	-90	-50	mV	
Receiver Input Hysteresis	ΔV_{TH}	$V_{CM} = 0V$	25	-	20	-	mV	
Receiver Output High Voltage	V_{OH}	$I_O = -8mA$, $V_{ID} = -50mV$	Full	$V_{CC} - 1.2$	4.3	-	V	
Receiver Output Low Voltage	V_{OL}	$I_O = -8mA$, $V_{ID} = -200mV$	Full	-	0.25	0.4	V	
Receiver Output Low Current	I_{OL}	$V_O = 1V$, $V_{ID} = -200mV$	Full	20	28	-	mA	
Three-State (High Impedance) Receiver Output Current	I_{OZR}	$0.4V \leq V_O \leq 2.4V$	Full	-1	0.03	1	μA	
Receiver Input Resistance	R_{IN}	$-7V \leq V_{CM} \leq 12V$	Full	96	160	-	k Ω	
Receiver Short-Circuit Current	I_{OSR}	$0V \leq V_O \leq V_{CC}$	Full	± 7	65	± 85	mA	
SUPPLY CURRENT								
No-Load Supply Current (Note 10)	I_{CC}	Half Duplex Versions, $DE = V_{CC}$, $\overline{RE} = X$, $DI = 0V$ or V_{CC}	Full	-	650	800	μA	
		All Versions, $DE = 0V$, $\overline{RE} = 0V$, or Full Duplex Versions, $DE = V_{CC}$, $\overline{RE} = X$. $DI = 0V$ or V_{CC}	Full	-	550	700	μA	
Shutdown Supply Current	I_{SHDN}	$DE = 0V$, $\overline{RE} = V_{CC}$, $DI = 0V$ or V_{CC}	Full	-	0.07	3	μA	
ESD PERFORMANCE								
RS-485 Pins (A, Y, B, Z, A/Y, B/Z)		IEC61000-4-2, Air-Gap Discharge Method	1/2 Duplex	25	-	± 16.5	-	kV
			Full Duplex	25	-	± 10	-	kV
		IEC61000-4-2, Contact Discharge Method	25	-	± 9	-	kV	
		Human Body Model, From Bus Pins to GND	25	-	± 16.5	-	kV	
All Pins		Human Body Model, per MIL-STD-883 Method 3015	25	-	± 7	-	kV	
		Machine Model	25	-	400	-	V	

Electrical Specifications Test Conditions: $V_{CC} = 4.5V$ to $5.5V$; Unless Otherwise Specified. Typicals are at $V_{CC} = 5V$, $T_A = +25^{\circ}C$ (Note 9). **Boldface limits apply across the operating temperature range, $-40^{\circ}C$ to $+85^{\circ}C$. (Continued)**

PARAMETER	SYMBOL	TEST CONDITIONS	TEMP ($^{\circ}C$)	MIN (Note 17)	TYP	MAX (Note 17)	UNIT
DRIVER SWITCHING CHARACTERISTICS (115kbps Versions; ISL3150E, ISL3152E)							
Driver Differential Output Delay	t_{PLH}, t_{PHL}	$R_{DIFF} = 54\Omega, C_L = 100pF$ (Figure 2)	Full	500	970	1300	ns
Driver Differential Output Skew	t_{SKEW}	$R_{DIFF} = 54\Omega, C_L = 100pF$ (Figure 2)	Full	-	12	50	ns
Driver Differential Rise or Fall Time	t_R, t_F	$R_{DIFF} = 54\Omega, C_L = 100pF$ (Figure 2)	Full	700	1100	1600	ns
Maximum Data Rate	f_{MAX}	$C_D = 820pF$ (Figure 4) (Note 20)	Full	115	2000	-	kbps
Driver Enable to Output High	t_{ZH}	$R_L = 500\Omega, C_L = 100pF, SW = GND$ (Figure 3), (Note 12)	Full	-	300	600	ns
Driver Enable to Output Low	t_{ZL}	$R_L = 500\Omega, C_L = 100pF, SW = V_{CC}$ (Figure 3), (Note 12)	Full	-	130	500	ns
Driver Disable from Output Low	t_{LZ}	$R_L = 500\Omega, C_L = 15pF, SW = V_{CC}$ (Figure 3)	Full	-	50	65	ns
Driver Disable from Output High	t_{HZ}	$R_L = 500\Omega, C_L = 15pF, SW = GND$ (Figure 3)	Full	-	35	60	ns
Time to Shutdown	t_{SHDN}	(Note 14)	Full	60	160	600	ns
Driver Enable from Shutdown to Output High	$t_{ZH}(SHDN)$	$R_L = 500\Omega, C_L = 100pF, SW = GND$ (Figure 3), (Notes 14, 15)	Full	-	-	250	ns
Driver Enable from Shutdown to Output Low	$t_{ZL}(SHDN)$	$R_L = 500\Omega, C_L = 100pF, SW = V_{CC}$ (Figure 3), (Notes 14, 15)	Full	-	-	250	ns
DRIVER SWITCHING CHARACTERISTICS (1Mbps Versions; ISL3153E, ISL3155E)							
Driver Differential Output Delay	t_{PLH}, t_{PHL}	$R_{DIFF} = 54\Omega, C_L = 100pF$ (Figure 2)	Full	150	270	400	ns
Driver Differential Output Skew	t_{SKEW}	$R_{DIFF} = 54\Omega, C_L = 100pF$ (Figure 2)	Full	-	3	10	ns
Driver Differential Rise or Fall Time	t_R, t_F	$R_{DIFF} = 54\Omega, C_L = 100pF$ (Figure 2)	Full	150	325	450	ns
Maximum Data Rate	f_{MAX}	$C_D = 820pF$ (Figure 4) (Note 20)	Full	1	8	-	Mbps
Driver Enable to Output High	t_{ZH}	$R_L = 500\Omega, C_L = 100pF, SW = GND$ (Figure 3), (Note 12)	Full	-	110	200	ns
Driver Enable to Output Low	t_{ZL}	$R_L = 500\Omega, C_L = 100pF, SW = V_{CC}$ (Figure 3), (Note 12)	Full	-	60	200	ns
Driver Disable from Output Low	t_{LZ}	$R_L = 500\Omega, C_L = 15pF, SW = V_{CC}$ (Figure 3)	Full	-	50	65	ns
Driver Disable from Output High	t_{HZ}	$R_L = 500\Omega, C_L = 15pF, SW = GND$ (Figure 3)	Full	-	35	60	ns
Time to Shutdown	t_{SHDN}	(Note 14)	Full	60	160	600	ns
Driver Enable from Shutdown to Output High	$t_{ZH}(SHDN)$	$R_L = 500\Omega, C_L = 100pF, SW = GND$ (Figure 3), (Notes 14, 15)	Full	-	-	250	ns
Driver Enable from Shutdown to Output Low	$t_{ZL}(SHDN)$	$R_L = 500\Omega, C_L = 100pF, SW = V_{CC}$ (Figure 3), (Notes 14, 15)	Full	-	-	250	ns

Electrical Specifications Test Conditions: $V_{CC} = 4.5V$ to $5.5V$; Unless Otherwise Specified. Typicals are at $V_{CC} = 5V$, $T_A = +25^{\circ}C$ (Note 9). **Boldface limits apply across the operating temperature range, $-40^{\circ}C$ to $+85^{\circ}C$.** (Continued)

PARAMETER	SYMBOL	TEST CONDITIONS	TEMP (°C)	MIN (Note 17)	TYP	MAX (Note 17)	UNIT
DRIVER SWITCHING CHARACTERISTICS (20Mbps Versions; ISL3156E, ISL3158E)							
Driver Differential Output Delay	t_{PLH}, t_{PHL}	$R_{DIFF} = 54\Omega, C_L = 100pF$ (Figure 2)	Full	-	21	30	ns
Driver Differential Output Skew	t_{SKEW}	$R_{DIFF} = 54\Omega, C_L = 100pF$ (Figure 2)	Full	-	0.2	3	ns
Driver Differential Rise or Fall Time	t_R, t_F	$R_{DIFF} = 54\Omega, C_L = 100pF$ (Figure 2)	Full	-	12	16	ns
Maximum Data Rate	f_{MAX}	$C_D = 470pF$ (Figure 4) (Note 20)	Full	20	55	-	Mbps
Driver Enable to Output High	t_{ZH}	$R_L = 500\Omega, C_L = 100pF, SW = GND$ (Figure 3), (Note 12)	Full	-	30	45	ns
Driver Enable to Output Low	t_{ZL}	$R_L = 500\Omega, C_L = 100pF, SW = V_{CC}$ (Figure 3), (Note 12)	Full	-	28	45	ns
Driver Disable from Output Low	t_{LZ}	$R_L = 500\Omega, C_L = 15pF, SW = V_{CC}$ (Figure 3)	Full	-	50	65	ns
Driver Disable from Output High	t_{HZ}	$R_L = 500\Omega, C_L = 15pF, SW = GND$ (Figure 3)	Full	-	38	60	ns
Time to Shutdown	t_{SHDN}	(Note 14)	Full	60	160	600	ns
Driver Enable from Shutdown to Output High	$t_{ZH}(SHDN)$	$R_L = 500\Omega, C_L = 100pF, SW = GND$ (Figure 3), (Notes 14, 15)	Full	-	-	200	ns
Driver Enable from Shutdown to Output Low	$t_{ZL}(SHDN)$	$R_L = 500\Omega, C_L = 100pF, SW = V_{CC}$ (Figure 3), (Notes 14, 15)	Full	-	-	200	ns
RECEIVER SWITCHING CHARACTERISTICS (115kbps and 1Mbps Versions; ISL3150E through ISL3155E)							
Maximum Data Rate	f_{MAX}	(Figure 5) (Note 20)	Full	1	12	-	Mbps
Receiver Input to Output Delay	t_{PLH}, t_{PHL}	(Figure 5)	Full	-	100	150	ns
Receiver Skew $t_{PLH} - t_{PHL}$	t_{SKD}	(Figure 5)	Full	-	4	10	ns
Receiver Enable to Output Low	t_{ZL}	$R_L = 1k\Omega, C_L = 15pF, SW = V_{CC}$ (Figure 6), (Note 13)	Full	-	9	20	ns
Receiver Enable to Output High	t_{ZH}	$R_L = 1k\Omega, C_L = 15pF, SW = GND$ (Figure 6), (Note 13)	Full	-	7	20	ns
Receiver Disable from Output Low	t_{LZ}	$R_L = 1k\Omega, C_L = 15pF, SW = V_{CC}$ (Figure 6)	Full	-	8	15	ns
Receiver Disable from Output High	t_{HZ}	$R_L = 1k\Omega, C_L = 15pF, SW = GND$ (Figure 6)	Full	-	8	15	ns
Time to Shutdown	t_{SHDN}	(Note 14)	Full	60	160	600	ns
Receiver Enable from Shutdown to Output High	$t_{ZH}(SHDN)$	$R_L = 1k\Omega, C_L = 15pF, SW = GND$ (Figure 6), (Notes 14, 16)	Full	-	-	200	ns
Receiver Enable from Shutdown to Output Low	$t_{ZL}(SHDN)$	$R_L = 1k\Omega, C_L = 15pF, SW = V_{CC}$ (Figure 6), (Notes 14, 16)	Full	-	-	200	ns
RECEIVER SWITCHING CHARACTERISTICS (20Mbps Versions; ISL3156E, ISL3158E)							
Maximum Data Rate	f_{MAX}	(Figure 5) (Note 20)	Full	20	30	-	Mbps
Receiver Input to Output Delay	t_{PLH}, t_{PHL}	(Figure 5)	Full	-	33	45	ns

Electrical Specifications Test Conditions: $V_{CC} = 4.5V$ to $5.5V$; Unless Otherwise Specified. Typicals are at $V_{CC} = 5V$, $T_A = +25^{\circ}C$ (Note 9). **Boldface limits apply across the operating temperature range, $-40^{\circ}C$ to $+85^{\circ}C$. (Continued)**

PARAMETER	SYMBOL	TEST CONDITIONS	TEMP (°C)	MIN (Note 17)	TYP	MAX (Note 17)	UNIT
Receiver Skew $t_{PLH} - t_{PHL}$	t_{SKD}	(Figure 5)	Full	-	2.5	5	ns
Receiver Enable to Output Low	t_{ZL}	$R_L = 1k\Omega$, $C_L = 15pF$, SW = V_{CC} (Figure 6), (Note 13)	Full	-	8	15	ns
Receiver Enable to Output High	t_{ZH}	$R_L = 1k\Omega$, $C_L = 15pF$, SW = GND (Figure 6), (Note 13)	Full	-	7	15	ns
Receiver Disable from Output Low	t_{LZ}	$R_L = 1k\Omega$, $C_L = 15pF$, SW = V_{CC} (Figure 6)	Full	-	8	15	ns
Receiver Disable from Output High	t_{HZ}	$R_L = 1k\Omega$, $C_L = 15pF$, SW = GND (Figure 6)	Full	-	8	15	ns
Time to Shutdown	t_{SHDN}	(Note 14)	Full	60	160	600	ns
Receiver Enable from Shutdown to Output High	$t_{ZH}(SHDN)$	$R_L = 1k\Omega$, $C_L = 15pF$, SW = GND (Figure 6), (Notes 14, 16)	Full	-	-	200	ns
Receiver Enable from Shutdown to Output Low	$t_{ZL}(SHDN)$	$R_L = 1k\Omega$, $C_L = 15pF$, SW = V_{CC} (Figure 6), (Notes 14, 16)	Full	-	-	200	ns

NOTES:

9. All currents in to device pins are positive; all currents out of device pins are negative. All voltages are referenced to device ground unless otherwise specified.
10. Supply current specification is valid for loaded drivers when DE = 0V.
11. Applies to peak current. See "Typical Performance Curves" beginning on page 14 for more information.
12. Keep $\overline{RE} = 0$ to prevent the device from entering SHDN.
13. The \overline{RE} signal high time must be short enough (typically <100ns) to prevent the device from entering SHDN.
14. Transceivers are put into shutdown by bringing \overline{RE} high and DE low. If the inputs are in this state for less than 60ns, the parts are guaranteed not to enter shutdown. If the inputs are in this state for at least 600ns, the parts are guaranteed to have entered shutdown. See "Low Power Shutdown Mode" on page 13
15. Keep $\overline{RE} = V_{CC}$, and set the DE signal low time >600ns to ensure that the device enters SHDN.
16. Set the \overline{RE} signal high time >600ns to ensure that the device enters SHDN.
17. Parameters with MIN and/or MAX limits are 100% tested at +25°C, unless otherwise specified. Temperature limits established by characterization and are not production tested.
18. See Figure 8 for more information, and for performance over-temperature.
19. Tested according to TIA/EIA-485-A, Section 4.2.6 ($\pm 100V$ for 15µs at a 1% duty cycle).
20. Limits established by characterization and are not production tested.

Test Circuits and Waveforms

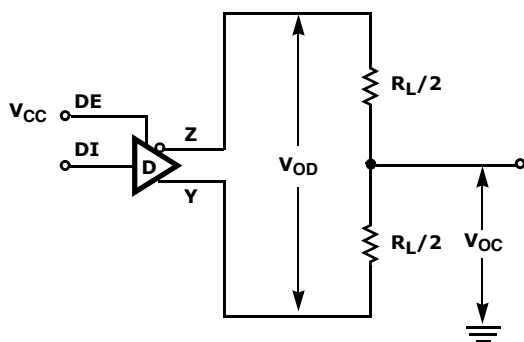

FIGURE 1A. V_{OD} AND V_{OC}

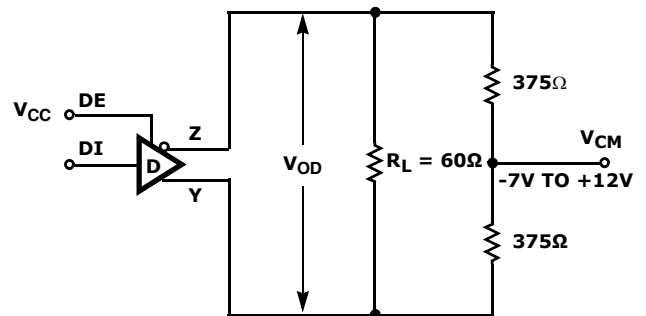

FIGURE 1B. V_{OD} WITH COMMON MODE LOAD

FIGURE 1. DC DRIVER TEST CIRCUITS

Test Circuits and Waveforms (Continued)

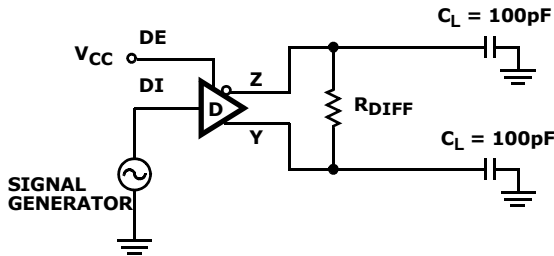

FIGURE 2A. TEST CIRCUIT

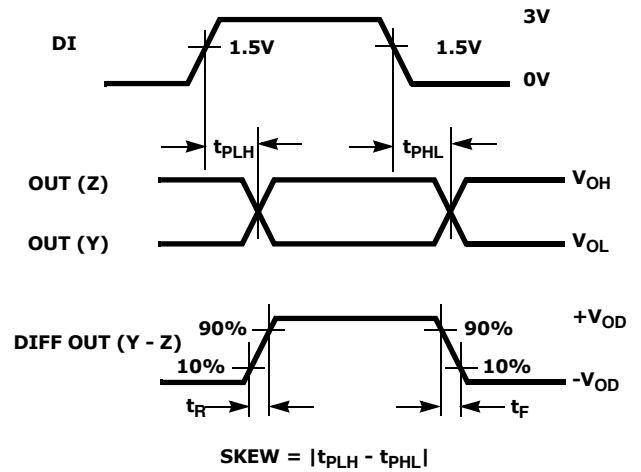
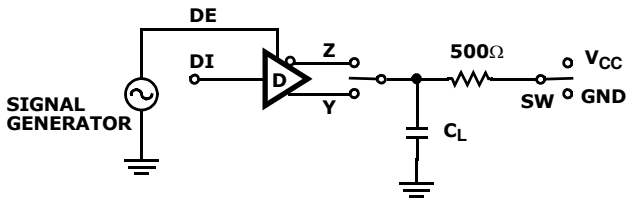

FIGURE 2B. MEASUREMENT POINTS

FIGURE 2. DRIVER PROPAGATION DELAY AND DIFFERENTIAL TRANSITION TIMES



PARAMETER	OUTPUT	\overline{RE}	DI	SW	C_L (pF)
t_{HZ}	Y/Z	X	1/0	GND	15
t_{LZ}	Y/Z	X	0/1	V_{CC}	15
t_{ZH}	Y/Z	0 (Note 12)	1/0	GND	100
t_{ZL}	Y/Z	0 (Note 12)	0/1	V_{CC}	100
$t_{ZH(SHDN)}$	Y/Z	1 (Note 15)	1/0	GND	100
$t_{ZL(SHDN)}$	Y/Z	1 (Note 15)	0/1	V_{CC}	100

FIGURE 3A. TEST CIRCUIT

FIGURE 3. DRIVER ENABLE AND DISABLE TIMES

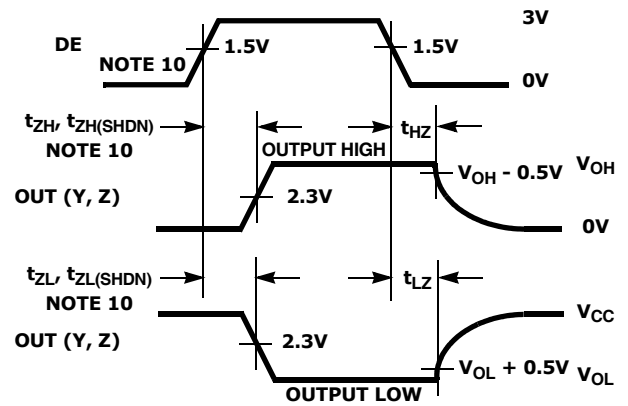

FIGURE 3B. MEASUREMENT POINTS

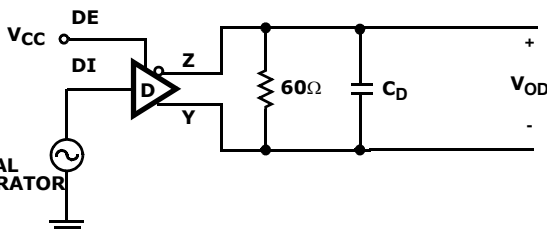

FIGURE 4A. TEST CIRCUIT

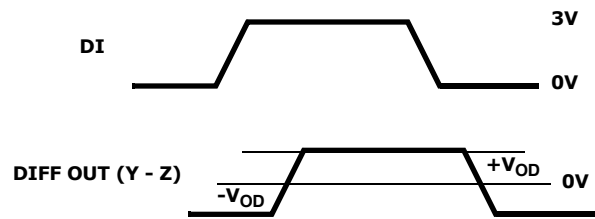

FIGURE 4B. MEASUREMENT POINTS

FIGURE 4. DRIVER DATA RATE

Test Circuits and Waveforms (Continued)

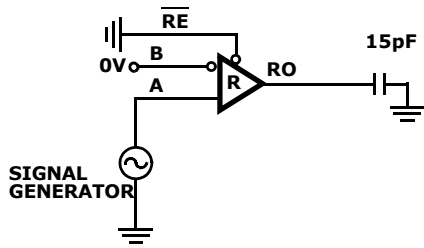

FIGURE 5A. TEST CIRCUIT

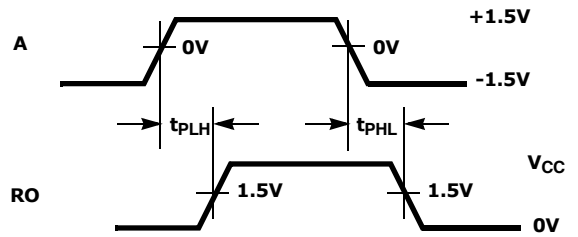
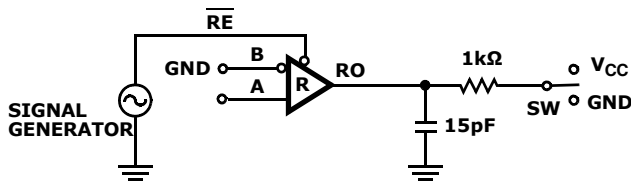

FIGURE 5B. MEASUREMENT POINTS

FIGURE 5. RECEIVER PROPAGATION DELAY AND DATA RATE



PARAMETER	DE	A	SW
t_{HZ}	0	+1.5V	GND
t_{LZ}	0	-1.5V	V_{CC}
t_{ZH} (Note 13)	0	+1.5V	GND
t_{ZL} (Note 13)	0	-1.5V	V_{CC}
$t_{ZH(SHDN)}$ (Note 16)	0	+1.5V	GND
$t_{ZL(SHDN)}$ (Note 16)	0	-1.5V	V_{CC}

FIGURE 6A. TEST CIRCUIT

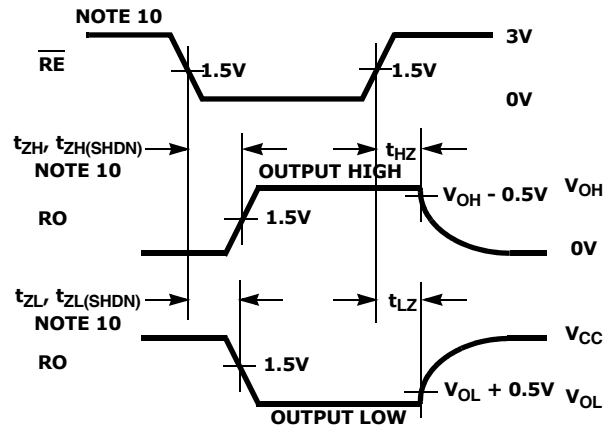

FIGURE 6B. MEASUREMENT POINTS

FIGURE 6. RECEIVER ENABLE AND DISABLE TIMES

Application Information

RS-485 and RS-422 are differential (balanced) data transmission standards used for long haul or noisy environments. RS-422 is a subset of RS-485, so RS-485 transceivers are also RS-422 compliant. RS-422 is a point-to-multipoint (multidrop) standard, which allows only one driver and up to 10 (assuming one unit load devices) receivers on each bus. RS-485 is a true multipoint standard, which allows up to 32 one unit load devices (any combination of drivers and receivers) on each bus. To allow for multipoint operation, the RS-485 specification requires that drivers must handle bus contention without sustaining any damage.

Another important advantage of RS-485 is the extended common mode range (CMR), which specifies that the driver outputs and receiver inputs withstand signals that range from +12V to -7V. RS-422 and RS-485 are intended for runs as long as 4000', so the wide CMR is necessary to handle ground potential differences, as well as voltages induced in the cable by external fields.

Receiver (Rx) Features

These devices use a differential input receiver for maximum noise immunity and common mode rejection. Input sensitivity is better than $\pm 200\text{mV}$, as required by the RS-422 and RS-485 specifications.

Rx outputs feature high drive levels (typically 28mA at $V_{OL} = 1\text{V}$) to ease the design of optically coupled isolated interfaces.

Receiver input resistance of 96k Ω surpasses the RS-422 specification of 4k Ω , and is eight times the RS-485 "Unit Load (UL)" requirement of 12k Ω minimum. Thus, these products are known as "one-eighth UL" transceivers, and there can be up to 256 of these devices on a network while still complying with the RS-485 loading specification.

Rx inputs function with common mode voltages as great as $\pm 7\text{V}$ outside the power supplies (that is, +12V and -7V), making them ideal for long networks where induced voltages are a realistic concern.

All the receivers include a "full fail-safe" function that guarantees a high level receiver output if the receiver inputs are unconnected (floating), shorted together, or connected to a terminated bus with all the transmitters disabled.

Receivers easily meet the data rates supported by the corresponding driver, and all receiver outputs are three-statable through the active low $\overline{\text{RE}}$ input.

Driver (Tx) Features

The RS-485/RS-422 driver is a differential output device that delivers at least 2.4V across a 54 Ω load (RS-485), and at least 2.8V across a 100 Ω load (RS-422). The drivers feature low propagation delay skew to maximize bit width, and to minimize EMI, and all drivers are three-statable through the active high DE input.

The 115kbps and 1Mbps driver outputs are slew rate limited to minimize EMI, and to minimize reflections in unterminated or improperly terminated networks. Outputs of the ISL3156E and ISL3158E drivers are not limited, so faster output transition times allow data rates of at least 20Mbps.

HIGH V_{OD} IMPROVES NOISE IMMUNITY AND FLEXIBILITY

The ISL315xE driver design delivers larger differential output voltages (V_{OD}) than the RS-485 standard requires, or than most RS-485 transmitters can deliver. The minimum $\pm 2.4\text{V}$ V_{OD} guarantees at least $\pm 900\text{mV}$ more noise immunity than networks built using standard 1.5V V_{OD} transmitters.

Another advantage of the large V_{OD} is the ability to drive more than two bus terminations, which allows for using the ISL315xE in "star" and other multi-terminated, "nonstandard" network topologies. Figure 8 details the transmitter's V_{OD} vs I_{OUT} characteristic, and includes load lines for six (20 Ω) and eight (15 Ω) 120 Ω terminations. The figure shows that the driver typically delivers 1.65/1.5V into 6/8 terminations, even at the worst case temperature of +85 $^{\circ}\text{C}$. The RS-485 standard requires a minimum 1.5V V_{OD} into two terminations, but the ISL315xE delivers RS-485 voltage levels with 3x to 4x the number of terminations.

Hot Plug Function

When a piece of equipment powers up, there is a period of time where the processor or ASIC driving the RS-485 control lines (DE, $\overline{\text{RE}}$) is unable to ensure that the RS-485 Tx and Rx outputs are kept disabled. If the equipment is connected to the bus, a driver activating prematurely during power-up may crash the bus. To avoid this scenario, the ISL315xE devices incorporate a "Hot Plug" function. Circuitry monitoring V_{CC} ensures that, during power-up and power-down, the Tx and Rx outputs remain disabled, regardless of the state of DE and $\overline{\text{RE}}$, if V_{CC} is less than $\sim 3.4\text{V}$. This gives the processor/ASIC a chance to stabilize and drive the RS-485 control lines to the proper states.

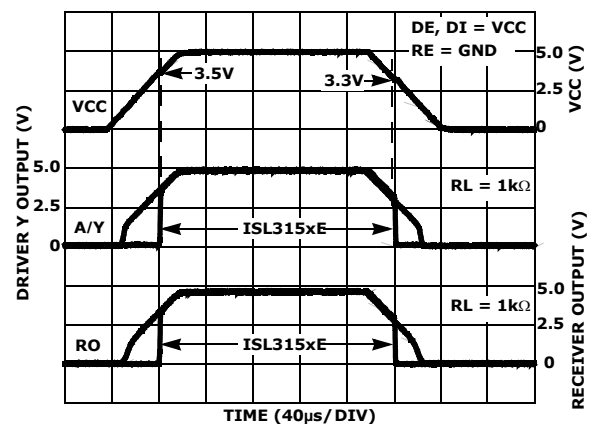

FIGURE 7. HOT PLUG PERFORMANCE (ISL315xE) vs ISL83088E WITHOUT HOT PLUG CIRCUITRY

ESD Protection

All pins on these devices include class 3 (>7kV) Human Body Model (HBM) ESD protection structures, but the RS-485 pins (driver outputs and receiver inputs) incorporate advanced structures allowing them to survive ESD events in excess of $\pm 16.5\text{kV}$ HBM and $\pm 16.5\text{kV}$ (1/2 duplex) IEC61000-4-2. The RS-485 pins are particularly vulnerable to ESD strikes because they typically connect to an exposed port on the exterior of the finished product. Simply touching the port pins, or connecting a cable, can cause an ESD event that might destroy unprotected ICs. These new ESD structures protect the device whether or not it is powered up, and without degrading the RS-485 common mode range of -7V to +12V. This built-in ESD protection eliminates the need for board level protection structures (such as transient suppression diodes), and the associated, undesirable capacitive load they present.

IEC61000-4-2 Testing

The IEC61000 test method applies to finished equipment, rather than to an individual IC. Therefore, the pins most likely to suffer an ESD event are those that are exposed to the outside world (the RS-485 pins in this case), and the IC is tested in its typical application configuration (power applied) rather than testing each pin-to-pin combination. The IEC61000 standard's lower current limiting resistor coupled with the larger charge storage capacitor yields a test that is much more severe than the HBM test. The extra ESD protection built into this device's RS-485 pins allows the design of equipment meeting level 4 criteria without the need for additional board level protection on the RS-485 port.

AIR-GAP DISCHARGE TEST METHOD

For this test method, a charged probe tip moves toward the IC pin until the voltage arcs to it. The current waveform delivered to the IC pin depends on approach speed, humidity, temperature, etc., so it is difficult to obtain repeatable results. The ISL315xE 1/2 duplex RS-485 pins withstand $\pm 16.5\text{kV}$ air-gap discharges.

CONTACT DISCHARGE TEST METHOD

During the contact discharge test, the probe contacts the tested pin before the probe tip is energized, thereby eliminating the variables associated with the air-gap discharge. The result is a more repeatable and predictable test, but equipment limits prevent testing devices at voltages higher than $\pm 9\text{kV}$. The RS-485 pins of all the ISL315xE versions survive $\pm 9\text{kV}$ contact discharges.

Data Rate, Cables, and Terminations

RS-485/RS-422 are intended for network lengths up to 4000', but the maximum system data rate decreases as the transmission length increases. Devices operating at 20Mbps are limited to lengths less than 100', while the 115kbps versions can operate at full data rates with lengths of several 1000'.

Twisted pair is the cable of choice for RS-485/RS-422 networks. Twisted pair cables tend to pick up noise and other electromagnetically induced voltages as common mode signals, which are effectively rejected by the differential receivers in these ICs.

Proper termination is imperative, when using the 20Mbps devices, to minimize reflections. Short networks using the 115kbps versions need not be terminated, but, terminations are recommended unless power dissipation is an overriding concern.

In point-to-point, or point-to-multipoint (single driver on bus) networks, the main cable should be terminated in its characteristic impedance (typically 120Ω) at the end farthest from the driver. In multi-receiver applications, stubs connecting receivers to the main cable should be kept as short as possible. Multipoint (multi-driver) systems require that the main cable be terminated in its characteristic impedance at both ends. Stubs connecting a transceiver to the main cable should be kept as short as possible.

Built-In Driver Overload Protection

As stated previously, the RS-485 specification requires that drivers survive worst case bus contentions undamaged. These devices meet this requirement through driver output short circuit current limits, and on-chip thermal shutdown circuitry.

The driver output stages incorporate short circuit current limiting circuitry which ensures that the output current never exceeds the RS-485 specification, even at the common mode voltage range extremes.

In the event of a major short circuit condition, devices also include a thermal shutdown feature that disables the drivers whenever the die temperature becomes excessive. This eliminates the power dissipation, allowing the die to cool. The drivers automatically re-enable after the die temperature drops about 15°C . If the contention persists, the thermal shutdown/re-enable cycle repeats until the fault is cleared. Receivers stay operational during thermal shutdown.

Low Power Shutdown Mode

These CMOS transceivers all use a fraction of the power required by their bipolar counterparts, but they also include a shutdown feature that reduces the already low quiescent I_{CC} to a 70nA trickle. These devices enter shutdown whenever the receiver and driver are *simultaneously* disabled ($\overline{RE} = V_{CC}$ and $DE = GND$) for a period of at least 600ns. Disabling both the driver and the receiver for less than 60ns guarantees that the transceiver will not enter shutdown.

Note that receiver and driver enable times increase when the transceiver enables from shutdown. Refer to [Notes 12, 13, 14, 15](#) and [16](#), at the end of the "Electrical Specification" table on [page 9](#) for more information.

Typical Performance Curves $V_{CC} = 5V, T_A = +25^\circ C$; Unless Otherwise Specified.

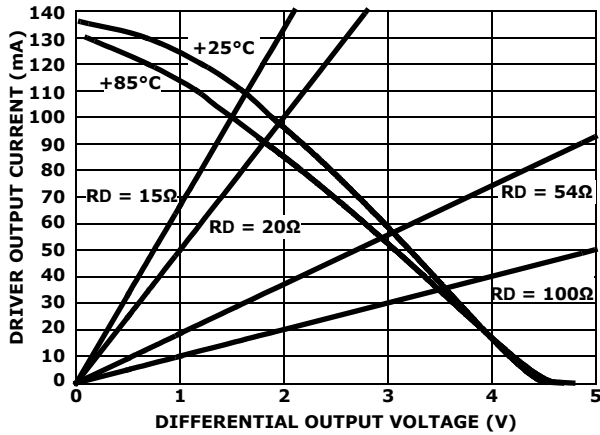

FIGURE 8. DRIVER OUTPUT CURRENT vs DIFFERENTIAL OUTPUT VOLTAGE

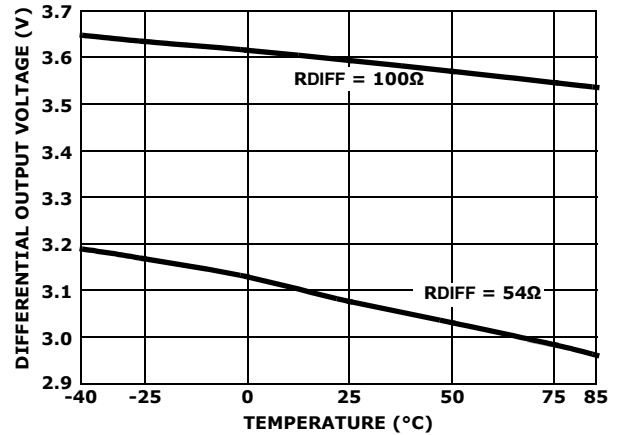

FIGURE 9. DRIVER DIFFERENTIAL OUTPUT VOLTAGE vs TEMPERATURE

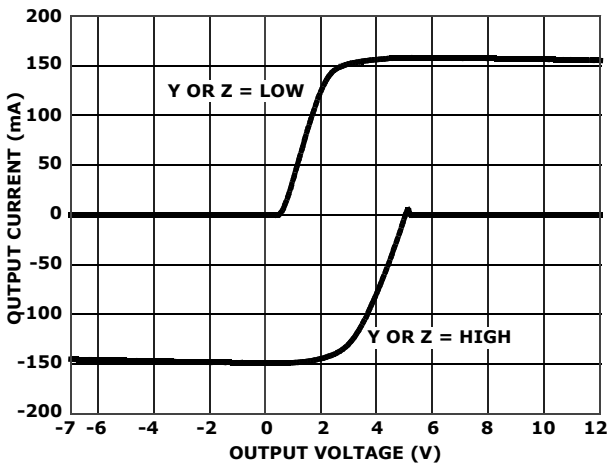

FIGURE 10. DRIVER OUTPUT CURRENT vs SHORT CIRCUIT VOLTAGE

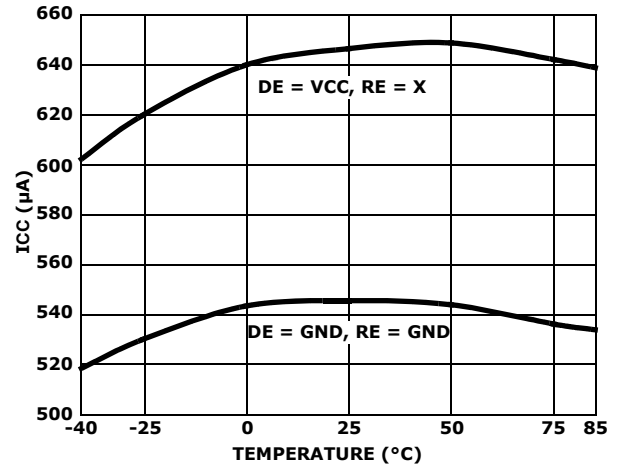

FIGURE 11. SUPPLY CURRENT vs TEMPERATURE

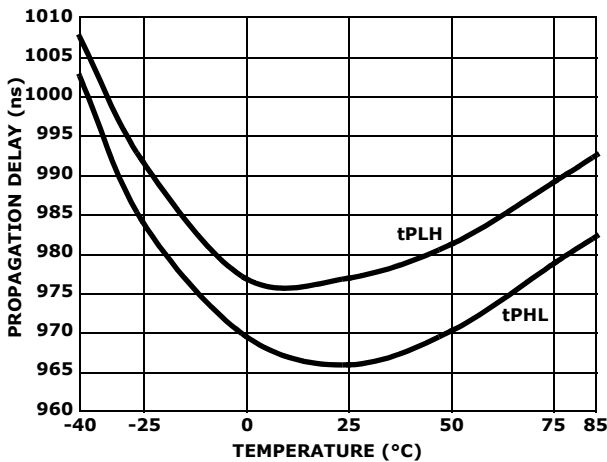

FIGURE 12. DRIVER DIFFERENTIAL PROPAGATION DELAY vs TEMPERATURE (ISL3150E, ISL3152E)

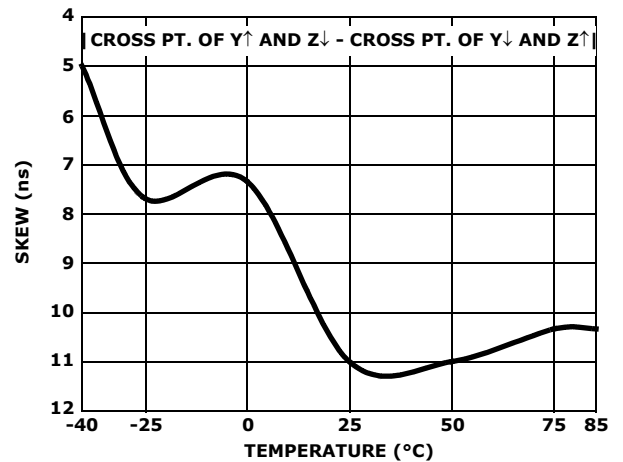

FIGURE 13. DRIVER DIFFERENTIAL SKEW vs TEMPERATURE (ISL3150E, ISL3152E)

Typical Performance Curves $V_{CC} = 5V, T_A = +25^{\circ}C$; Unless Otherwise Specified. (Continued)

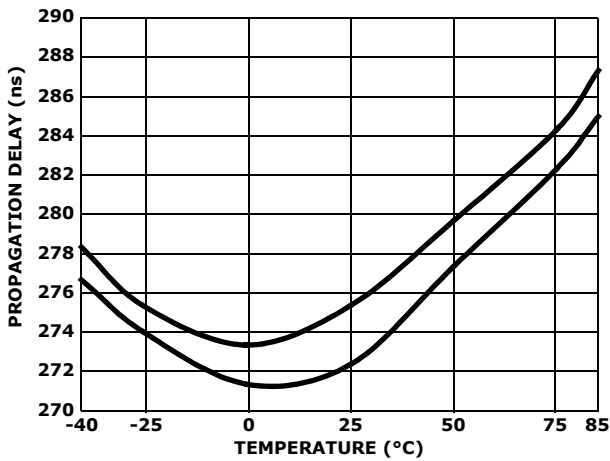

FIGURE 14. DRIVER DIFFERENTIAL PROPAGATION DELAY vs TEMPERATURE (ISL3153E, ISL3155E)

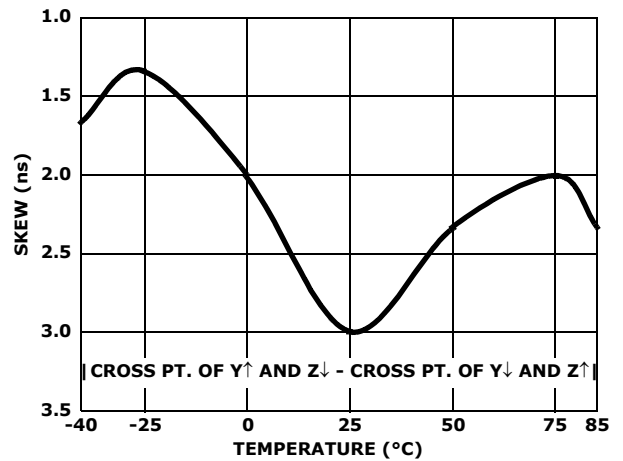

FIGURE 15. DRIVER DIFFERENTIAL SKEW vs TEMPERATURE (ISL3153E, ISL3155E)

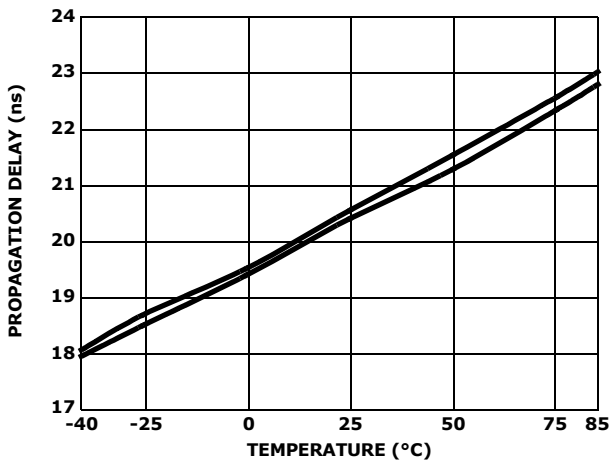

FIGURE 16. DRIVER DIFFERENTIAL PROPAGATION DELAY vs TEMPERATURE (ISL3156E, ISL3158E)

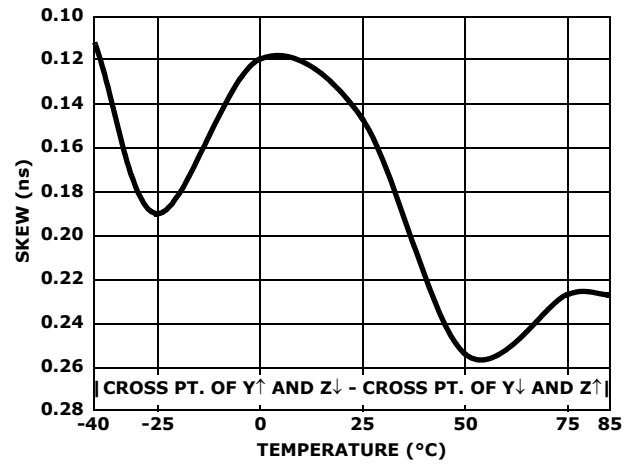

FIGURE 17. DRIVER DIFFERENTIAL SKEW vs TEMPERATURE (ISL3156E, ISL3158E)

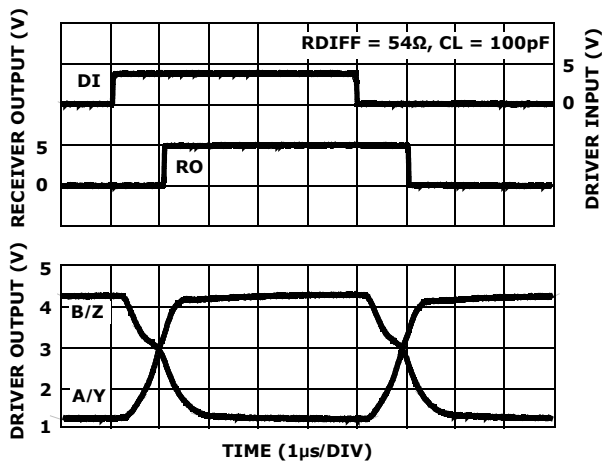

FIGURE 18. DRIVER AND RECEIVER WAVEFORMS, (ISL3150E, ISL3152E)

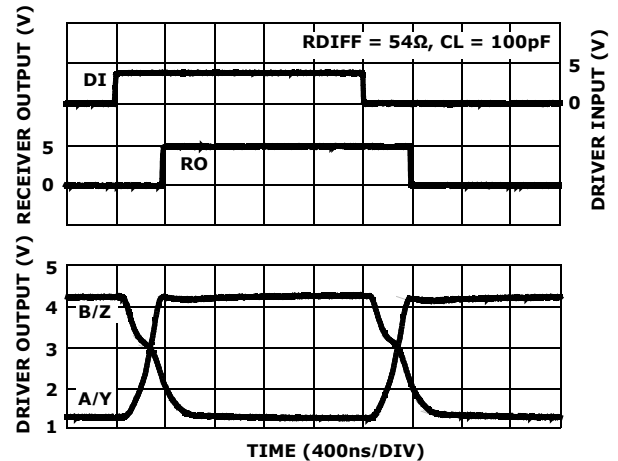

FIGURE 19. DRIVER AND RECEIVER WAVEFORMS, (ISL3153E, ISL3155E)

Typical Performance Curves $V_{CC} = 5V, T_A = +25^{\circ}C$; Unless Otherwise Specified. (Continued)

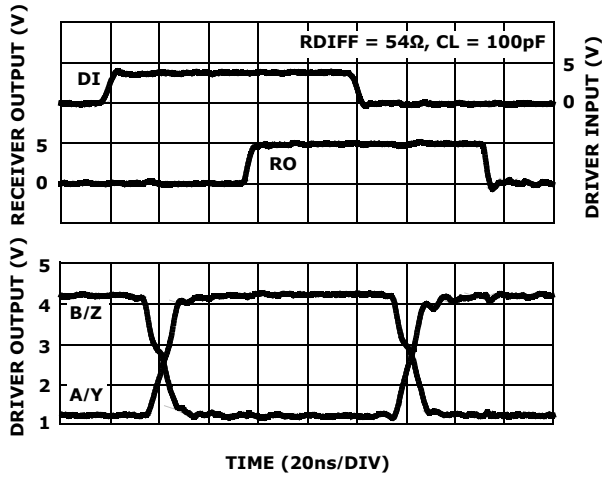

FIGURE 20. DRIVER AND RECEIVER WAVEFORMS, (ISL3156E, ISL3158E)

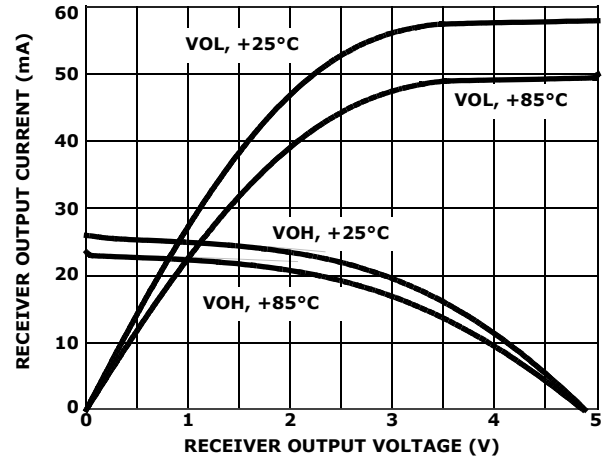

FIGURE 21. RECEIVER OUTPUT CURRENT vs RECEIVER OUTPUT VOLTAGE

Die Characteristics

SUBSTRATE POTENTIAL (POWERED UP):

GND

TRANSISTOR COUNT:

530

PROCESS:

Si Gate BiCMOS

Revision History

The revision history provided is for informational purposes only and is believed to be accurate, but not warranted. Please visit our website to make sure you have the latest revision.

DATE	REVISION	CHANGE
8/31/17	FN6363.3	<p>Updated the Receiving Truth Table on page 3. Updated header/footer. Added Related Literature Updated Ordering Information table. Updated Note 1. Added Notes 2, 3, and 4. Replaced Products section with About Intersil section. Updated the POD M8.118 from revision 2 to revision 4. Changes since revision 2: Updated to new format by adding land pattern and moving dimensions from the table to the drawing. Corrected lead width dimension in side view 1 from "0.25 - 0.036" to "0.25 - 0.36" Updated the POD M10.118 from revision 0 to revision 1. Changes since revision 0: Updated to new format by adding land pattern and moving dimensions from the table to the drawing. Updated the POD M14.15 from revision 0 to revision 1. Changes since revision 0: Updated to new format by adding land pattern and moving dimensions from the table to the drawing. Updated the POD M8.15 from revision 1 to revision 4. Changes since revision 1: Changed Note 1 "1982" to "1994" In the Typical Recommended Land Pattern, changed the following: 2.41(0.095) to 2.20(0.087) 0.76 (0.030) to 0.60(0.023) 0.200 to 5.20(0.205) Updated to new format by adding land pattern and moving dimensions from the table to the drawing.</p>
6/30/09	FN6363.2	<p>Converted to new Intersil template. Rev 2 changes are as follows: Page 1 - Introduction was reworded to fit graphs. Features Section by listing only key features. Added performance graphs. Page 2 - Updated Ordering information by numbering all notes and referencing them on each part. Added MSL Note as new standard with linked parts to device info page. Updated Pinout name to Pin Configurations with Pin Descriptions following on page 3. Page 5 - Added Boldface limit verbiage in Electrical specifications table and added bold formatting for Min and Max over-temperature limits. Page 17 - Added Revision History and Products information with all links included.</p>
1/17/08	FN6363.1	<p>Added 8 Ld PDIP to ordering information, POD, and Thermal resistance. Applied Intersil Standards as follows: Updated ordering information with Notes for tape and reel reference, Pb-free PDIP and lead finish. Added Pb-free reflow link and Pb-free note to Thermal Information. Added E8.3 POD.</p>
2/20/07	FN6363.0	<p>Cosmetic edit to the ISL315xE data sheet, no rev, no date change, no formal review. Removed both commas in this sentence in the first paragraph: "Each driver output, and receiver input, is protected against ±16.5kV ESD strikes without latch-up."</p>
12/14/06	FN6363.0	Initial release

About Intersil

Intersil Corporation is a leading provider of innovative power management and precision analog solutions. The company's products address some of the largest markets within the industrial and infrastructure, mobile computing, and high-end consumer markets.

For the most updated datasheet, application notes, related documentation, and related parts, see the respective product information page found at www.intersil.com.

For a listing of definitions and abbreviations of common terms used in our documents, visit www.intersil.com/glossary.

You can report errors or suggestions for improving this datasheet by visiting www.intersil.com/ask.

Reliability reports are also available from our website at www.intersil.com/support.

© Copyright Intersil Americas LLC 2006-2017. All Rights Reserved.
All trademarks and registered trademarks are the property of their respective owners.

For additional products, see www.intersil.com/en/products.html

Intersil products are manufactured, assembled and tested utilizing ISO9001 quality systems as noted in the quality certifications found at www.intersil.com/en/support/qualandreliability.html

Intersil products are sold by description only. Intersil may modify the circuit design and/or specifications of products at any time without notice, provided that such modification does not, in Intersil's sole judgment, affect the form, fit or function of the product. Accordingly, the reader is cautioned to verify that datasheets are current before placing orders. Information furnished by Intersil is believed to be accurate and reliable. However, no responsibility is assumed by Intersil or its subsidiaries for its use; nor for any infringements of patents or other rights of third parties which may result from its use. No license is granted by implication or otherwise under any patent or patent rights of Intersil or its subsidiaries.

For information regarding Intersil Corporation and its products, see www.intersil.com

Package Outline Drawings

For the most recent package outline drawing, see [M8.118](#).

M8.118

8 LEAD MINI SMALL OUTLINE PLASTIC PACKAGE

Rev 4, 7/11

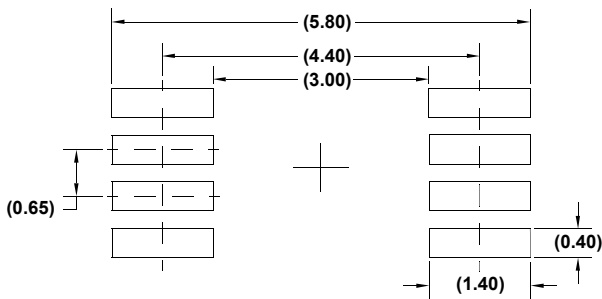
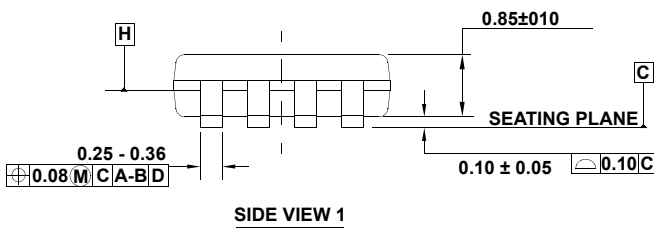
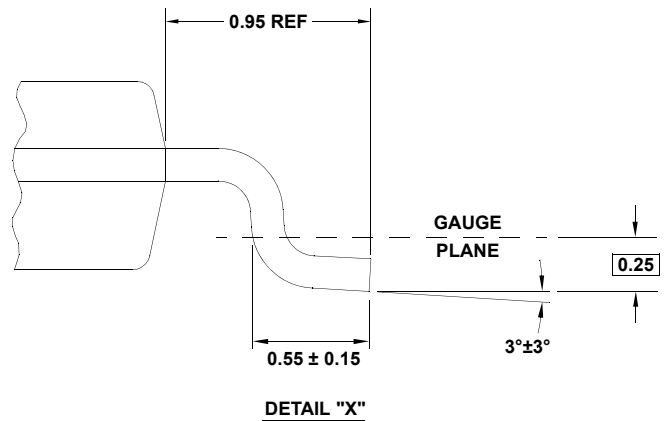
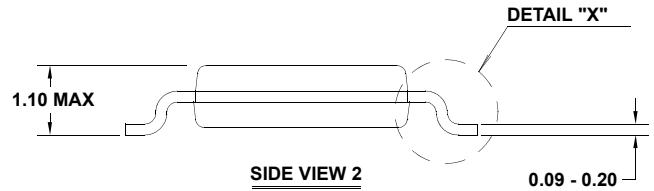
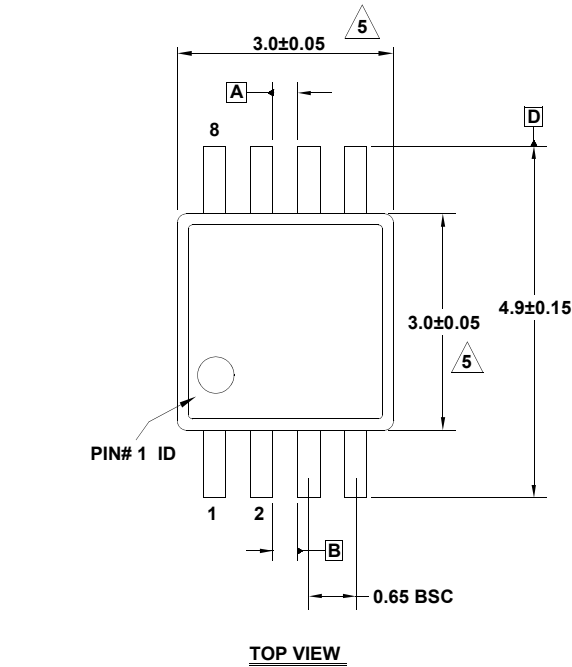

NOTES:

1. Dimensions are in millimeters.
2. Dimensioning and tolerancing conform to JEDEC MO-187-AA and AMSEY14.5m-1994.
3. Plastic or metal protrusions of 0.15mm max per side are not included.
4. Plastic interlead protrusions of 0.15mm max per side are not included.
5. Dimensions are measured at Datum Plane "H".
6. Dimensions in () are for reference only.

M10.118

10 LEAD MINI SMALL OUTLINE PLASTIC PACKAGE

Rev 1, 4/12

For the most recent package outline drawing, see [M10.118](#).

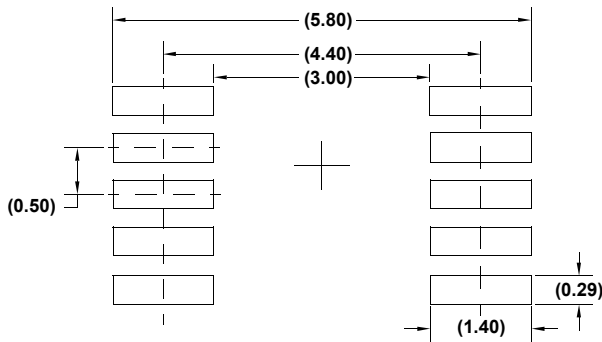
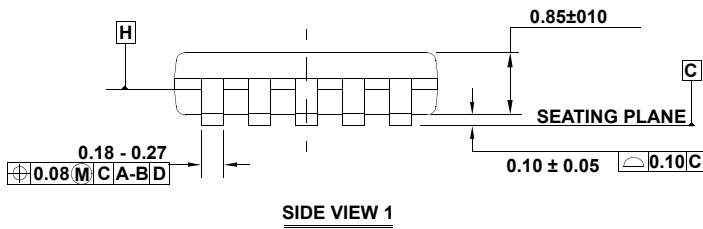
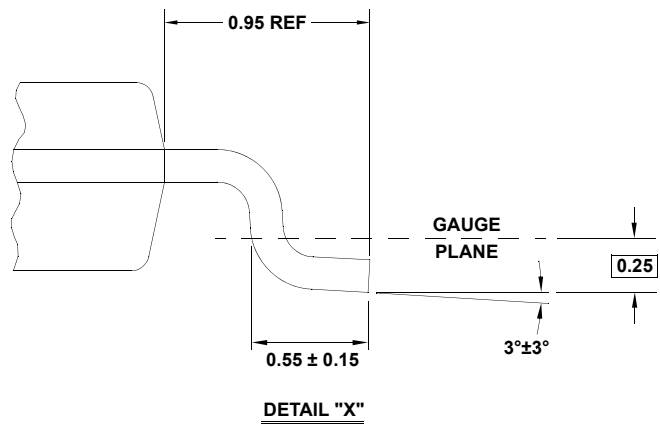
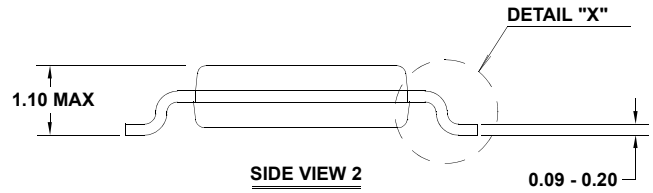
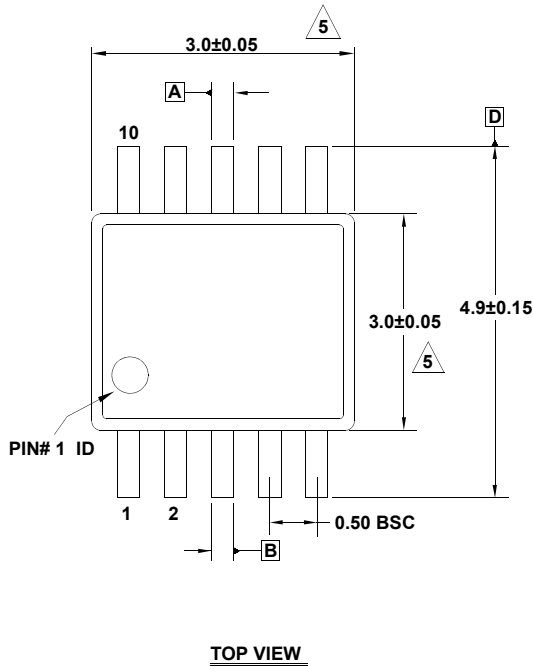

NOTES:

1. Dimensions are in millimeters.
2. Dimensioning and tolerancing conform to JEDEC MO-187-BA and AMSEY14.5m-1994.
3. Plastic or metal protrusions of 0.15mm max per side are not included.
4. Plastic interlead protrusions of 0.15mm max per side are not included.
5. Dimensions are measured at Datum Plane "H".
6. Dimensions in () are for reference only.

M14.15
 14 LEAD NARROW BODY SMALL OUTLINE PLASTIC PACKAGE
 Rev 1, 10/09

For the most recent package outline drawing, see [M14.15](#).

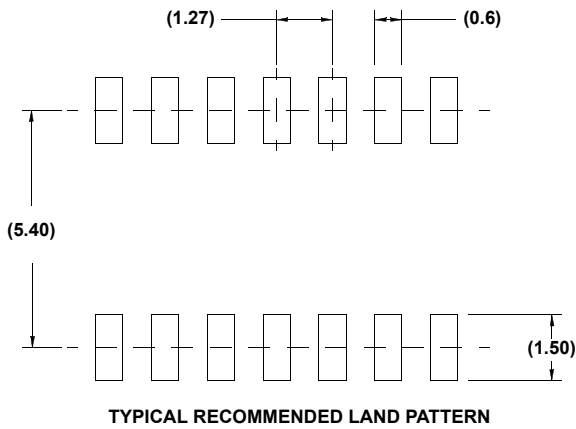
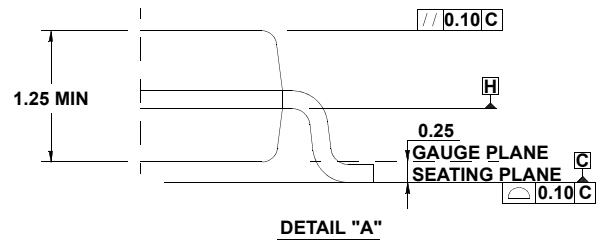
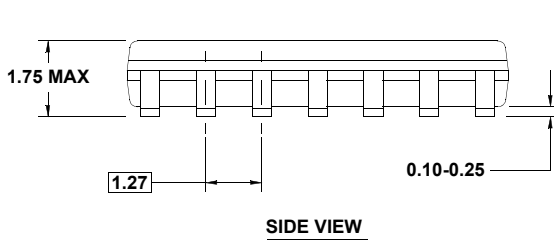
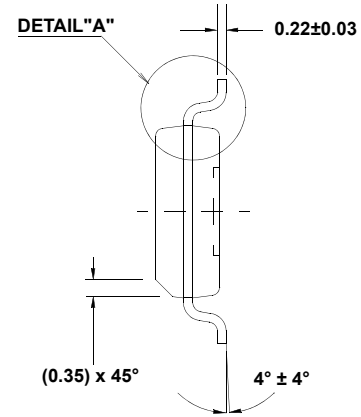
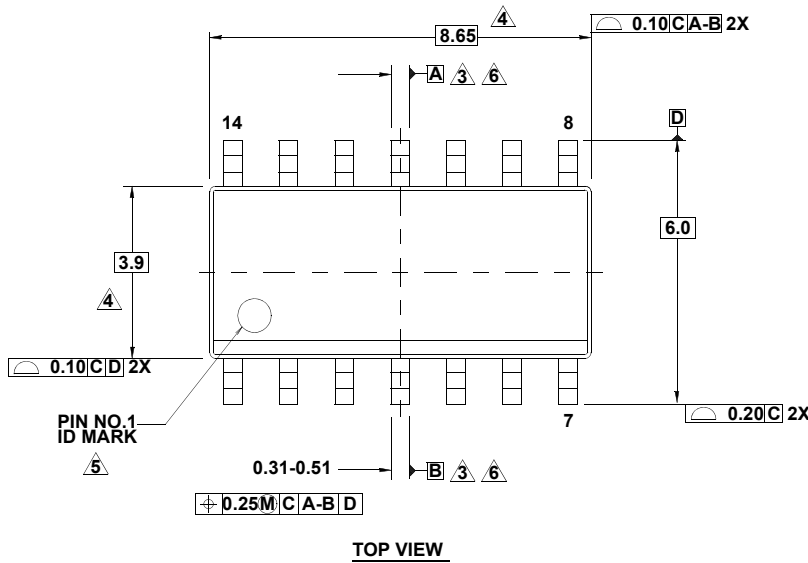

NOTES:

1. Dimensions are in millimeters.
Dimensions in () for Reference Only.
2. Dimensioning and tolerancing conform to AMSEY14.5m-1994.
3. Datums A and B to be determined at Datum H.
4. Dimension does not include interlead flash or protrusions.
Interlead flash or protrusions shall not exceed 0.25mm per side.
5. The pin #1 identifier may be either a mold or mark feature.
6. Does not include dambar protrusion. Allowable dambar protrusion shall be 0.10mm total in excess of lead width at maximum condition.
7. Reference to JEDEC MS-012-AB.

Dual-In-Line Plastic Packages (PDIP)

For the most recent package outline drawing, see [E8.3](#).

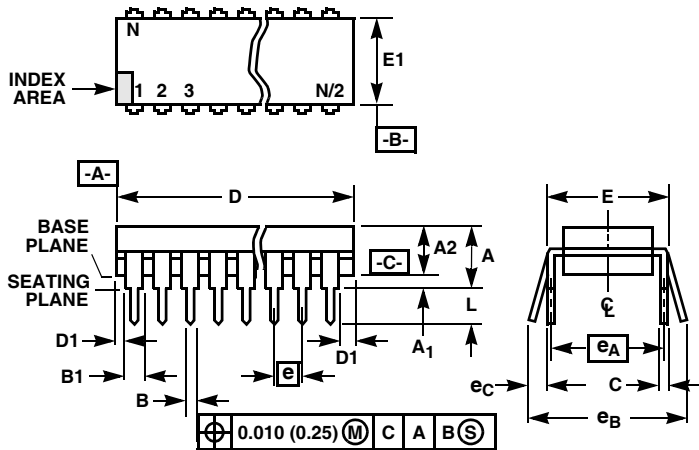

E8.3 (JEDEC MS-001-BA ISSUE D)
8 LEAD DUAL-IN-LINE PLASTIC PACKAGE

SYMBOL	INCHES		MILLIMETERS		NOTES
	MIN	MAX	MIN	MAX	
A	-	0.210	-	5.33	4
A1	0.015	-	0.39	-	4
A2	0.115	0.195	2.93	4.95	-
B	0.014	0.022	0.356	0.558	-
B1	0.045	0.070	1.15	1.77	8, 10
C	0.008	0.014	0.204	0.355	-
D	0.355	0.400	9.01	10.16	5
D1	0.005	-	0.13	-	5
E	0.300	0.325	7.62	8.25	6
E1	0.240	0.280	6.10	7.11	5
e	0.100 BSC		2.54 BSC		-
eA	0.300 BSC		7.62 BSC		6
eB	-	0.430	-	10.92	7
L	0.115	0.150	2.93	3.81	4
N	8		8		9

Rev. 0 12/93

NOTES:

- Controlling Dimensions: INCH. In case of conflict between English and Metric dimensions, the inch dimensions control.
- Dimensioning and tolerancing per ANSI Y14.5M-1982.
- Symbols are defined in the "MO Series Symbol List" in Section 2.2 of Publication No. 95.
- Dimensions A, A1 and L are measured with the package seated in JEDEC seating plane gauge GS-3.
- D, D1, and E1 dimensions do not include mold flash or protrusions. Mold flash or protrusions shall not exceed 0.010 inch (0.25mm).
- E and e_A are measured with the leads constrained to be perpendicular to datum -C-.
- e_B and e_C are measured at the lead tips with the leads unconstrained. e_C must be zero or greater.
- B1 maximum dimensions do not include dambar protrusions. Dambar protrusions shall not exceed 0.010 inch (0.25mm).
- N is the maximum number of terminal positions.
- Corner leads (1, N, N/2 and N/2 + 1) for E8.3, E16.3, E18.3, E28.3, E42.6 will have a B1 dimension of 0.030 - 0.045 inch (0.76 - 1.14mm).

M8.15

8 LEAD NARROW BODY SMALL OUTLINE PLASTIC PACKAGE

Rev 4, 1/12

For the most recent package outline drawing, see [M8.15](#).

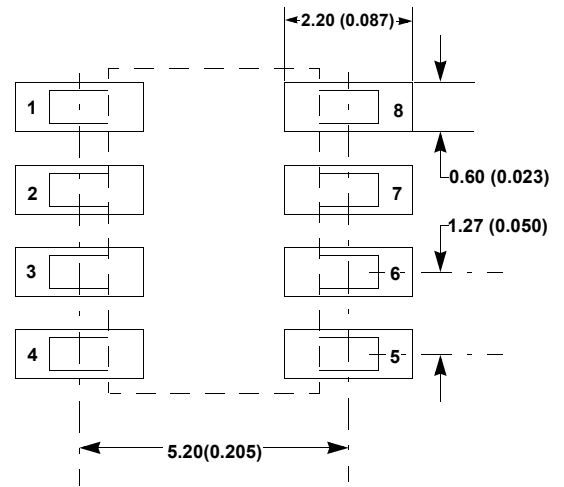
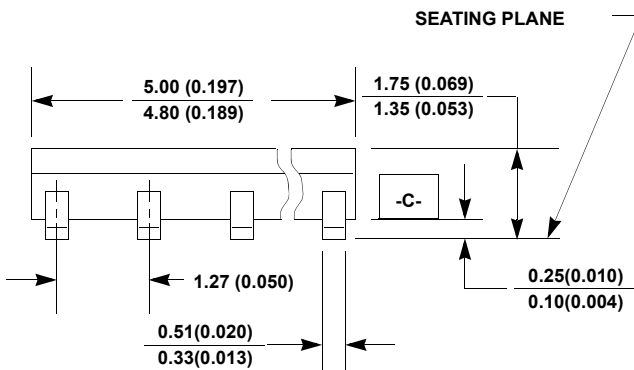
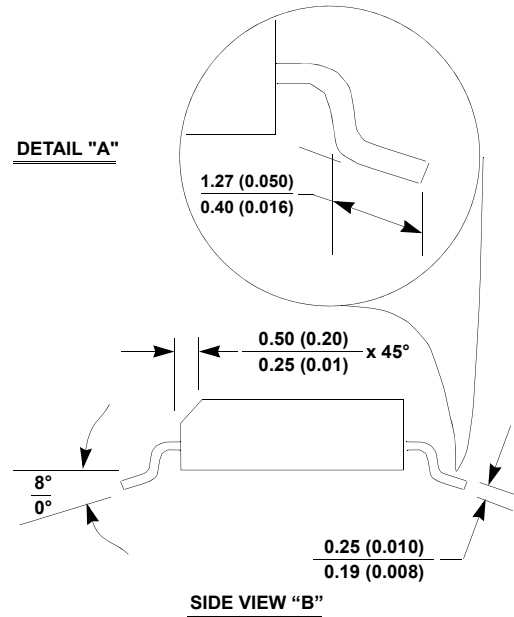
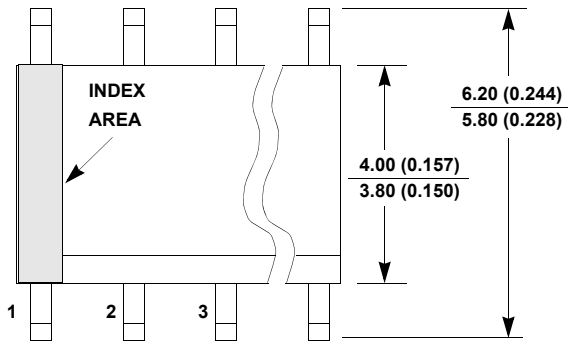

NOTES:

1. Dimensioning and tolerancing per ANSI Y14.5M-1994.
2. Package length does not include mold flash, protrusions or gate burrs. Mold flash, protrusion and gate burrs shall not exceed 0.15mm (0.006 inch) per side.
3. Package width does not include interlead flash or protrusions. Interlead flash and protrusions shall not exceed 0.25mm (0.010 inch) per side.
4. The chamfer on the body is optional. If it is not present, a visual index feature must be located within the crosshatched area.
5. Terminal numbers are shown for reference only.
6. The lead width as measured 0.36mm (0.014 inch) or greater above the seating plane, shall not exceed a maximum value of 0.61mm (0.024 inch).
7. Controlling dimension: MILLIMETER. Converted inch dimensions are not necessarily exact.
8. This outline conforms to JEDEC publication MS-012-AA ISSUE C.

Mouser Electronics

Authorized Distributor

Click to View Pricing, Inventory, Delivery & Lifecycle Information:

Intersil:

[ISL3150EIBZ](#) [ISL3150EIBZ-T](#) [ISL3150EIBZ-T7A](#) [ISL3150EIUZ](#) [ISL3150EIUZ-T](#) [ISL3150EIUZ-T7A](#) [ISL3152EIBZ](#)
[ISL3152EIBZ-T](#) [ISL3152EIBZ-T7A](#) [ISL3152EIPZ](#) [ISL3152EIUZ](#) [ISL3152EIUZ-T](#) [ISL3152EIUZ-T7A](#) [ISL3153EIBZ-T](#)
[ISL3153EIUZ](#) [ISL3153EIUZ-T](#) [ISL3153EIUZ-T7A](#) [ISL3155EIBZ](#) [ISL3155EIBZ-T](#) [ISL3155EIBZ-T7A](#) [ISL3155EIUZ](#)
[ISL3155EIUZ-T](#) [ISL3156EIBZ](#) [ISL3156EIBZ-T](#) [ISL3156EIBZ-T7A](#) [ISL3156EIUZ](#) [ISL3156EIUZ-T](#) [ISL3156EIUZ-T7A](#)
[ISL3158EIBZ](#) [ISL3158EIBZ-T](#) [ISL3158EIBZ-T7A](#) [ISL3158EIUZ](#) [ISL3158EIUZ-T](#) [ISL3158EIUZ-T7A](#)