

THIS DRAWING IS UNPUBLISHED  
 RELEASED FOR PUBLICATION NOV, 2001.  
 ALL RIGHTS RESERVED.

LOC	DIST	REVISIONS					
IR	-	P	LTR	DESCRIPTION	DATE	DWN	APVD
			E3	ECR-10-026537	27JUN11	KK	HMR

- NOTE:
- 1 MATERIAL :  
HOUSING : NYLON 66 OR EQUIVALENT, UL94V-0, BLACK COLOUR.  
CONTACT : COPPER ALLOY
  - 2 FINISH:  
CONTACT : GOLD PLATED (SEE TABLE) ON CONTACT AREA  
80μ" MIN. TIN PLATED ON SOLDER TAIL,  
50μ" MIN. NICKEL UNDERPLATED ALL OVER.
3. APPLICATION :  
SOLDERTAIL LENGTH 2.6 FOR PCB THICKNESS 1.6±0.1  
1.2 FOR PCB THICKNESS 0.3 MAX.
4. KEYING POS. : HOUSING CAVITY MOLDED SHUT
5. QUALIFICATION TEST REPORT: 501-57197

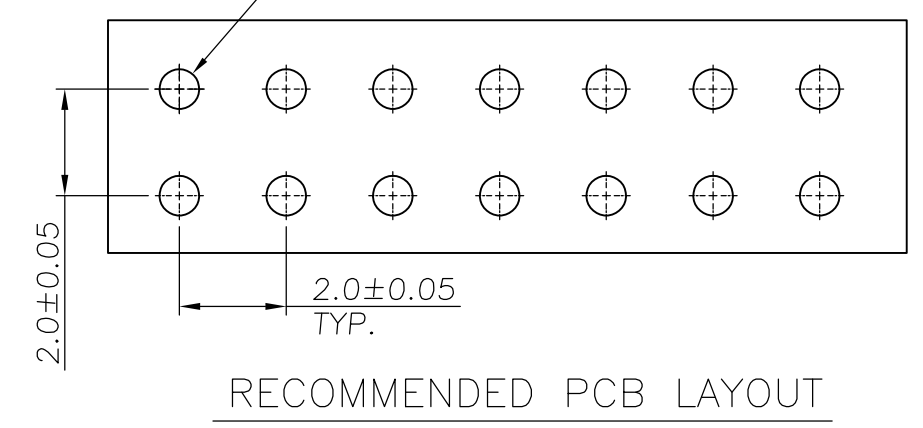
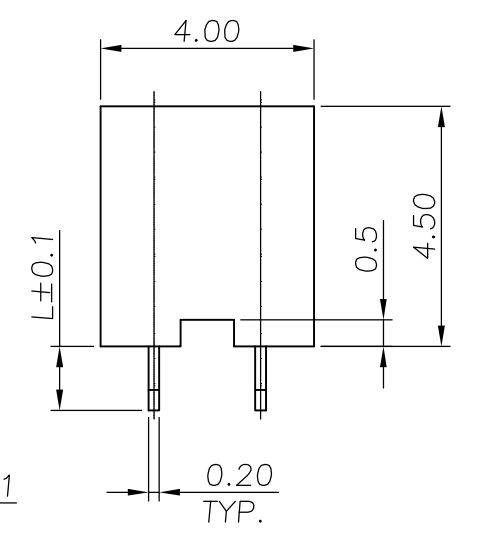
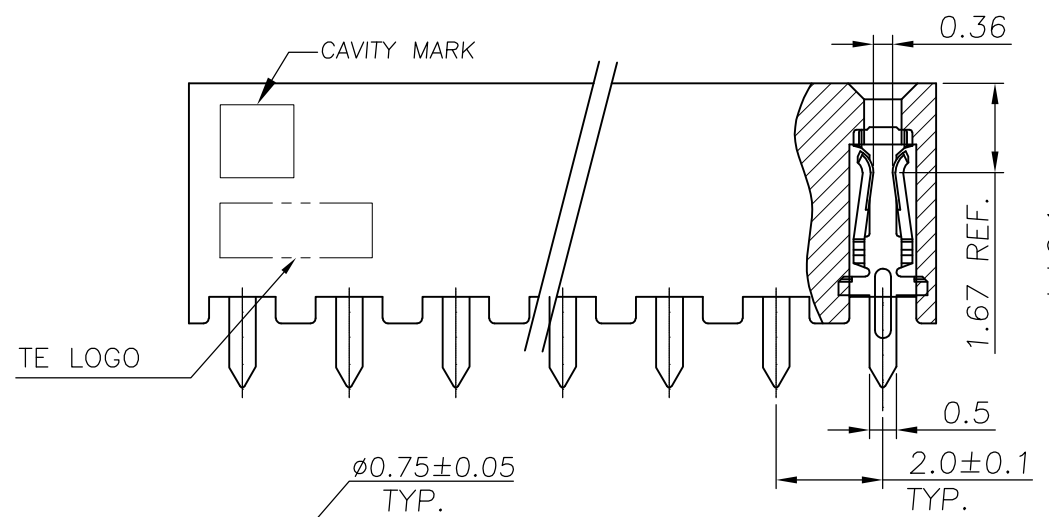
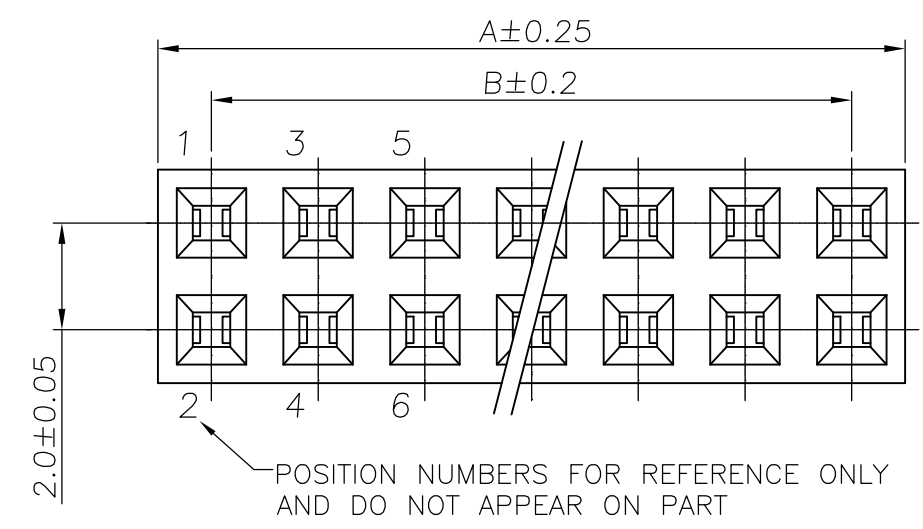
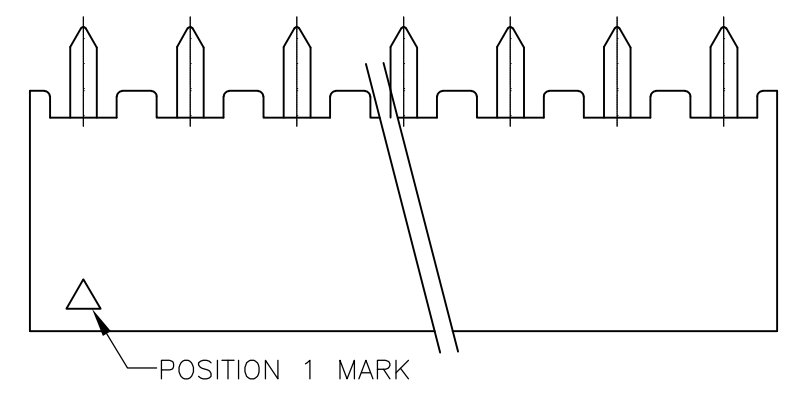

OBSOLETE		6	40	38	40	9	-9	
OBSOLETE			50	48	50	9	-8	
OBSOLETE			48	46	48	9	-7	
OBSOLETE			46	44	46	9	-6	
OBSOLETE			44	42	44	9	-5	
OBSOLETE			42	40	42	9	-4	
OBSOLETE			40	38	40	9	-3	
OBSOLETE			38	36	38	9	-2	
OBSOLETE			36	34	36	9	-1	
OBSOLETE			34	32	34	9	0	
OBSOLETE			32	30	32	8	-9	
OBSOLETE			30	28	30	8	-8	
OBSOLETE			28	26	28	8	-7	
OBSOLETE			26	24	26	8	-6	
OBSOLETE			24	22	24	8	-5	
OBSOLETE			22	20	22	8	-4	
OBSOLETE			20	18	20	8	-3	
OBSOLETE			18	16	18	8	-2	
OBSOLETE			16	14	16	8	-1	
OBSOLETE			14	12	14	8	0	
OBSOLETE			12	10	12	7	-9	
OBSOLETE			10	8	10	7	-8	
OBSOLETE			8	6	8	7	-7	
OBSOLETE			6	4	6	7	-6	
OBSOLETE			4	2	4	7	-5	
OBSOLETE			50	48	50	7	-4	
OBSOLETE			48	46	48	7	-3	
OBSOLETE			46	44	46	7	-2	
OBSOLETE			44	42	44	7	-1	
OBSOLETE			42	40	42	7	0	
OBSOLETE			40	38	40	6	-9	
OBSOLETE			38	36	38	6	-8	
OBSOLETE			36	34	36	6	-7	
OBSOLETE			34	32	34	6	-6	
OBSOLETE			32	30	32	6	-5	
OBSOLETE			30	28	30	6	-4	
OBSOLETE			28	26	28	6	-3	
OBSOLETE			26	24	26	6	-2	
OBSOLETE			24	22	24	6	-1	
OBSOLETE			22	20	22	6	0	
OBSOLETE			20	18	20	5	-9	
OBSOLETE			18	16	18	5	-8	
OBSOLETE			16	14	16	5	-7	
OBSOLETE			14	12	14	5	-6	
OBSOLETE			12	10	12	5	-5	
OBSOLETE			10	8	10	5	-4	
OBSOLETE			8	6	8	5	-3	
OBSOLETE			6	4	6	5	-2	
OBSOLETE			4	2	4	5	-1	

THIS DRAWING IS A CONTROLLED DOCUMENT.

DWN O.HU 30-NOV-2001  
 CHK J.CHENG 30-NOV-2001  
 APVD J.WU 30-NOV-2001

NAME: AMPMODU 2.0mm PITCH REC CONN,VERTICAL MOUNT TYPE

PRODUCT SPEC: 108-57197

APPLICATION SPEC: -

SIZE: A3 CAGE CODE: - DRAWING NO: C-1470209 RESTRICTED TO: -

WEIGHT: -

CUSTOMER DRAWING SCALE: 1:1 SHEET: 1 OF 2 REV: E3

THIS DRAWING IS UNPUBLISHED  
 © COPYRIGHT 2009 By -  
 ALL RIGHTS RESERVED.

RELEASED FOR PUBLICATION  
 NOV ,2001.

LOC	DIST	REVISIONS			
P	LTR	DESCRIPTION	DATE	DWN	APVD
	-	SEE SHEET 1	-	-	-

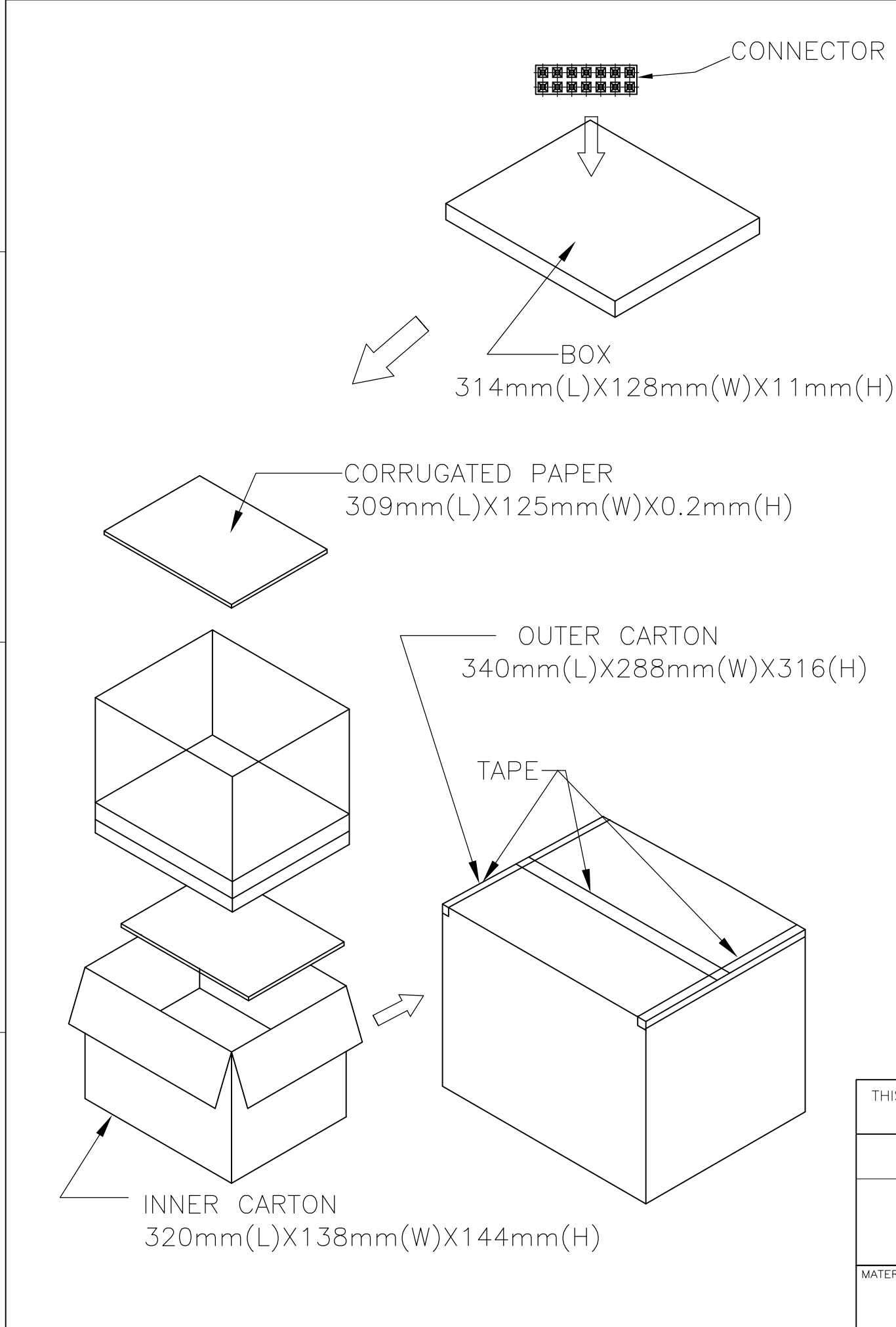

OBSOLETE	"L"	Pcs/Carton	Pcs/Inner Carton	Pcs/BOX	POS.	PART NUMBER
OBSOLETE	5040	1260	105	40	9	-9
OBSOLETE	4320	1080	90	50	9	-8
OBSOLETE	4320	1080	90	48	9	-7
OBSOLETE	4320	1080	90	46	9	-6
OBSOLETE	4320	1080	90	44	9	-5
OBSOLETE	5040	1260	105	42	9	-4
OBSOLETE	5040	1260	105	40	9	-3
OBSOLETE	5040	1260	105	38	9	-2
OBSOLETE	5760	1440	120	36	9	-1
OBSOLETE	5760	1440	120	34	9	0
OBSOLETE	6480	1620	135	32	8	-9
OBSOLETE	7200	1800	150	30	8	-8
OBSOLETE	7200	1800	150	28	8	-7
OBSOLETE	7920	1980	165	26	8	-6
OBSOLETE	8640	2160	180	24	8	-5
OBSOLETE	9360	2340	195	22	8	-4
OBSOLETE	10080	2520	210	20	8	-3
OBSOLETE	11520	2880	240	18	8	-2
OBSOLETE	12960	3240	270	16	8	-1
OBSOLETE	15120	3780	315	14	8	0
OBSOLETE	17280	4320	360	12	7	-9
OBSOLETE	20880	5220	435	10	7	-8
OBSOLETE	26640	6660	555	8	7	-7
OBSOLETE	35280	8820	735	6	7	-6
OBSOLETE	51840	12960	1080	4	7	-5
OBSOLETE	4320	1080	90	50	7	-4
OBSOLETE	4320	1080	90	48	7	-3
OBSOLETE	4320	1080	90	46	7	-2
OBSOLETE	4320	1080	90	44	7	-1
OBSOLETE	5040	1260	105	42	7	0
OBSOLETE	5040	1260	105	40	6	-9
OBSOLETE	5040	1260	105	38	6	-8
OBSOLETE	5760	1440	120	36	6	-7
OBSOLETE	5760	1440	120	34	6	-6
OBSOLETE	6480	1620	135	32	6	-5
OBSOLETE	7200	1800	150	30	6	-4
OBSOLETE	7200	1800	150	28	6	-3
OBSOLETE	7920	1980	165	26	6	-2
OBSOLETE	8640	2160	180	24	6	-1
OBSOLETE	9360	2340	195	22	6	0
OBSOLETE	10080	2520	210	20	5	-9
OBSOLETE	11520	2880	240	18	5	-8
OBSOLETE	12960	3240	270	16	5	-7
OBSOLETE	15120	3780	315	14	5	-6
OBSOLETE	17280	4320	360	12	5	-5
OBSOLETE	20880	5220	435	10	5	-4
OBSOLETE	26640	6660	555	8	5	-3
OBSOLETE	35280	8820	735	6	5	-2
OBSOLETE	51840	12960	1080	4	5	-1

OBSOLETE	"L"	Pcs/Carton	Pcs/Inner Carton	Pcs/BOX	POS.	PART NUMBER
OBSOLETE	5040	1260	105	40	4	-9
OBSOLETE	4320	1080	90	50	4	-8
OBSOLETE	4320	1080	90	48	4	-7
OBSOLETE	4320	1080	90	46	4	-6
OBSOLETE	4320	1080	90	44	4	-5
OBSOLETE	5040	1260	105	42	4	-4
OBSOLETE	5040	1260	105	40	4	-3
OBSOLETE	5040	1260	105	38	4	-2
OBSOLETE	5760	1440	120	36	4	-1
OBSOLETE	5760	1440	120	34	4	0
OBSOLETE	6480	1620	135	32	3	-9
OBSOLETE	7200	1800	150	30	3	-8
OBSOLETE	7200	1800	150	28	3	-7
OBSOLETE	7920	1980	165	26	3	-6
OBSOLETE	8640	2160	180	24	3	-5
OBSOLETE	9360	2340	195	22	3	-4
OBSOLETE	10080	2520	210	20	3	-3
OBSOLETE	11520	2880	240	18	3	-2
OBSOLETE	12960	3240	270	16	3	-1
OBSOLETE	15120	3780	315	14	3	0
OBSOLETE	17280	4320	360	12	2	-9
OBSOLETE	20880	5220	435	10	2	-8
OBSOLETE	26640	6660	555	8	2	-7
OBSOLETE	35280	8820	735	6	2	-6
OBSOLETE	51840	12960	1080	4	2	-5
OBSOLETE	4320	1080	90	50	2	-4
OBSOLETE	4320	1080	90	48	2	-3
OBSOLETE	4320	1080	90	46	2	-2
OBSOLETE	4320	1080	90	44	2	-1
OBSOLETE	5040	1260	105	42	2	0
OBSOLETE	5040	1260	105	40	1	-9
OBSOLETE	5040	1260	105	38	1	-8
OBSOLETE	5760	1440	120	36	1	-7
OBSOLETE	5760	1440	120	34	1	-6
OBSOLETE	6480	1620	135	32	1	-5
OBSOLETE	7200	1800	150	30	1	-4
OBSOLETE	7200	1800	150	28	1	-3
OBSOLETE	7920	1980	165	26	1	-2
OBSOLETE	8640	2160	180	24	1	-1
OBSOLETE	9360	2340	195	22	1	0
OBSOLETE	10080	2520	210	20		-9
OBSOLETE	11520	2880	240	18		-8
OBSOLETE	12960	3240	270	16		-7
OBSOLETE	15120	3780	315	14		-6
OBSOLETE	17280	4320	360	12		-5
OBSOLETE	20880	5220	435	10		-4
OBSOLETE	26640	6660	555	8		-3
OBSOLETE	35280	8820	735	6		-2
OBSOLETE	51840	12960	1080	4		-1

THIS DRAWING IS A CONTROLLED DOCUMENT.		DWN O.HU 30-NOV-2001	 TE Connectivity AMPMODU 2.0mm PITCH REC CONN,VERTICAL MOUNT TYPE		
DIMENSIONS: mm		CHK J.CHENG 30-NOV-2001			
TOLERANCES UNLESS OTHERWISE SPECIFIED:		APVD J.WU 30-NOV-2001			
0 PLC ± - 1 PLC ± 0.15 2 PLC ± 0.10 3 PLC ± 0.05 4 PLC ± - ANGLES ± 3'		NAME			
MATERIAL SEE SHEET 1		FINISH SEE SHEET 1	PRODUCT SPEC 108-57197	APPLICATION SPEC	RESTRICTED TO
		WEIGHT -	SIZE A3	CAGE CODE -	DRAWING NO C-1470209
CUSTOMER DRAWING			SCALE 1:1	SHEET 2 OF 2	REV E3

# Mouser Electronics

Authorized Distributor

Click to View Pricing, Inventory, Delivery & Lifecycle Information:

[TE Connectivity:](#)

[9-1470209-8](#)