

## Sealed Nickel Cadmium Batteries

Model: PS-AAX

### Specifications

|   |                         |                 |
|---|-------------------------|-----------------|
| Nominal Voltage                           |                         | 1.2 Volt        |
| Rated Capacity                            |                         | 700 mAh         |
| Dimensions                                | Diameter in. (mm)       | 0.56 (14.1)     |
|   | Height in. (mm)         | 1.89 (48.0)     |
|   | Height with solder tabs | 1.93 (49.0)     |
|   | Weight Approx.          | 22 gm           |
|   | Internal Resistance     | < 27 mΩ         |
|   | Standard Charge (0.1C)  | 70 mA           |
|   | Trickle Charge          | (0.03C)~(0.05C) |
|   | Fast Charge ΔV          | 700 mA          |
| Recommended Operating Temperature Range   | Std/Trickle Charge      | 20±5°C          |
|   | Fast Charge             | 20±5°C          |
|   | Discharge               | 20±5°C          |
|   | Storage                 | -20°C to 45°C   |
| Standard Discharge (0.2C) Cut Off Voltage |                         | 1.0V per cell   |
| High Rate Discharge (1 C) Cut Off Voltage |                         | V per cell      |

### Dimensions

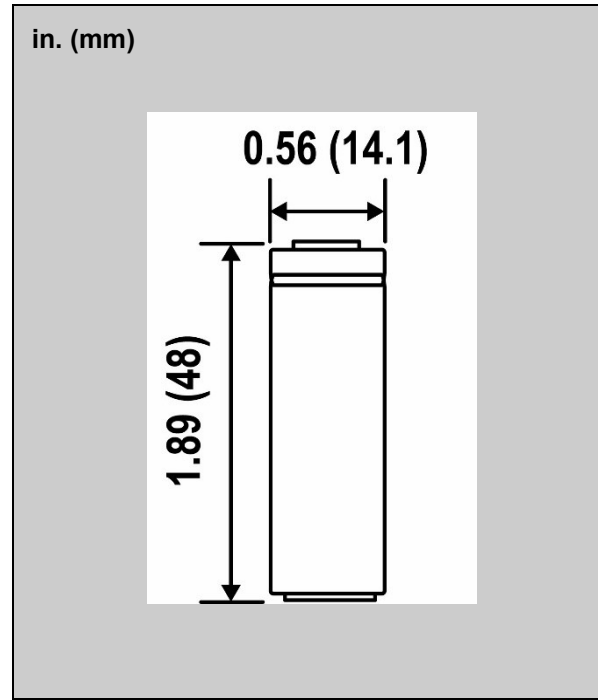

### Charging and Discharging Characteristics

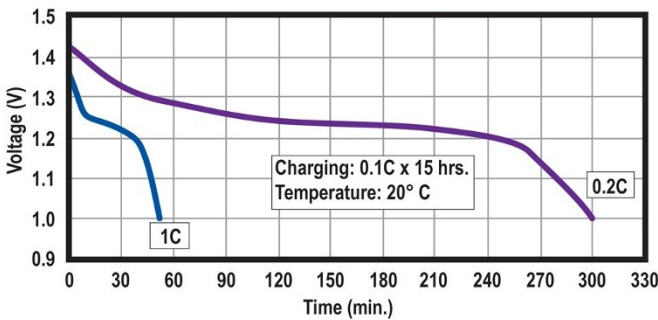

Discharge

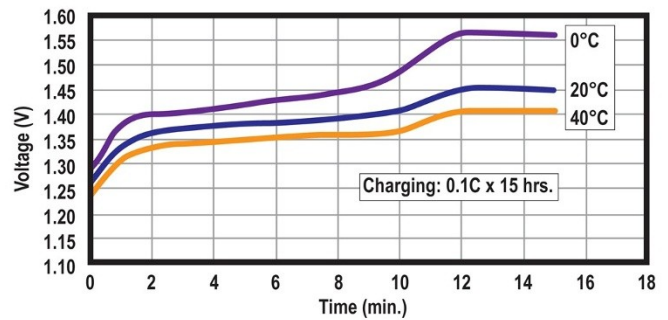

Standard Charge

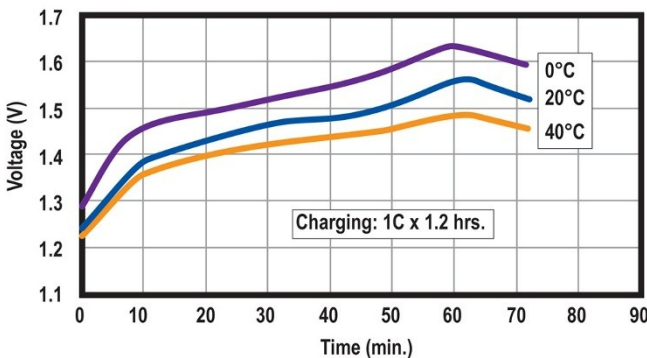

Fast Charge

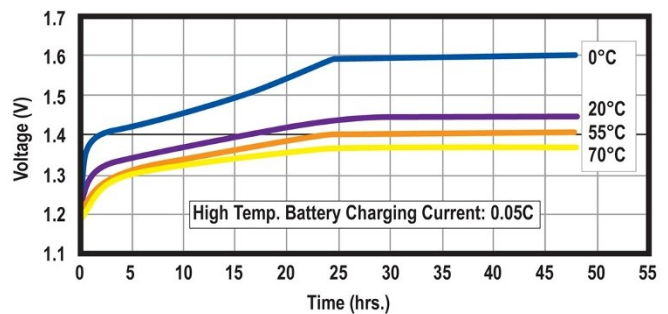

Trickle Charge



▲ Standard Battery Cycle Life ▲

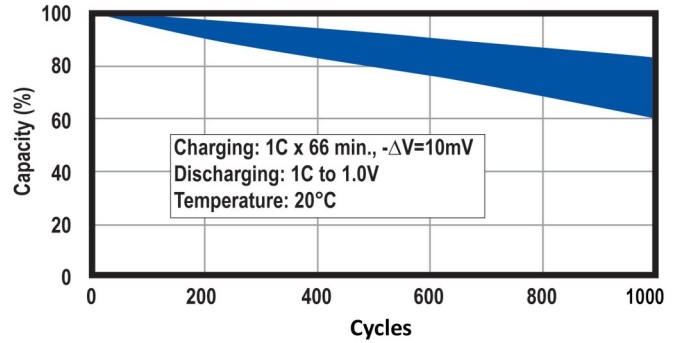

▲ Fast Charging Cycle Life ▲



▲ Cycle Life Using Trickle Charging ▲



▲ Stand-by Battery Life ▲



▲ Capacity vs. Temperature ▲

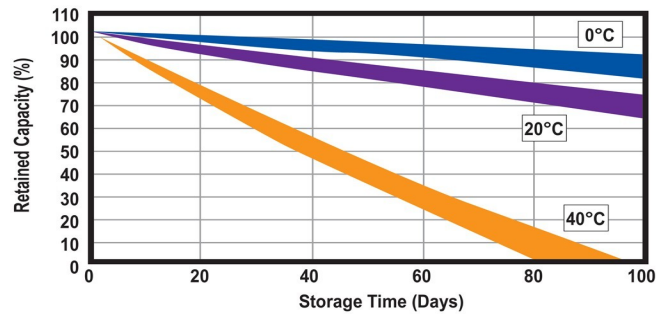

▲ Retained Capacity In Storage ▲

**Corporate Headquarters and Domestic Sales**  
 Power-Sonic Corporation • 7550 Panasonic Way • San Diego, CA 92154 • U.S.A  
 Phone: (619) 661-2020 • Fax: (619) 661.3650  
 Email Sales: [national-sales@power-sonic.com](mailto:national-sales@power-sonic.com)  
 Email Customer Service: [customer-service@power-sonic.com](mailto:customer-service@power-sonic.com)  
 E-mail Technical Support: [technical-support@power-sonic.com](mailto:technical-support@power-sonic.com)

**International Sales**  
 Power-Sonic Corporation • P.O. Box 5242 • Redwood City, CA 94063 • U.S.A.  
 Phone: (650) 364-5001 • Fax: (650) 366-3662  
 Email Sales: [international-sales.com@power-sonic.com](mailto:international-sales.com@power-sonic.com)

**[www.power-sonic.com](http://www.power-sonic.com)**

# Mouser Electronics

Authorized Distributor

Click to View Pricing, Inventory, Delivery & Lifecycle Information:

[Power-Sonic:](#)

[PS-AAX](#) [PS-AAX-T](#)