

Multilayer Varistor for ESD pulse [2 Array Type for high speed signal lines]

Series: **EZJZS**

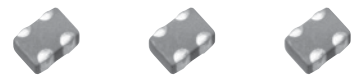

Features

- Excellent ESD suppression due to original advanced material technology
- Having large electrostatic resistance meeting IEC61000-4-2, Level 4 standard
- Having no polarity (bipolar) facilitated replacing Zener Diodes. Capable of replacing 2 Zener Diodes and 1 Capacitor
- 2 Array per package for multiple lines
- Lead-free terminal electrodes enabled great solderability
- Wide range of products is available by adopting multilayer structure, meeting various needs.
- Ultra low capacitance for signal lines of high speed busses
- Ideal for USB 2.0, IEEE1394, and HDMI high speed data busses
- RoHS compliant

As for Packaging Methods, Handling Precautions

Please see Data Files

Explanation of Part Numbers

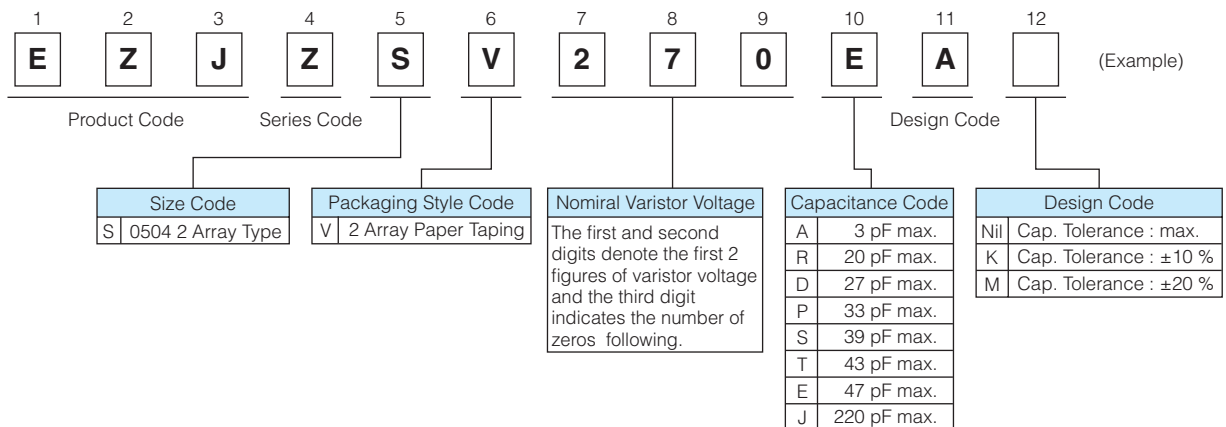

Construction

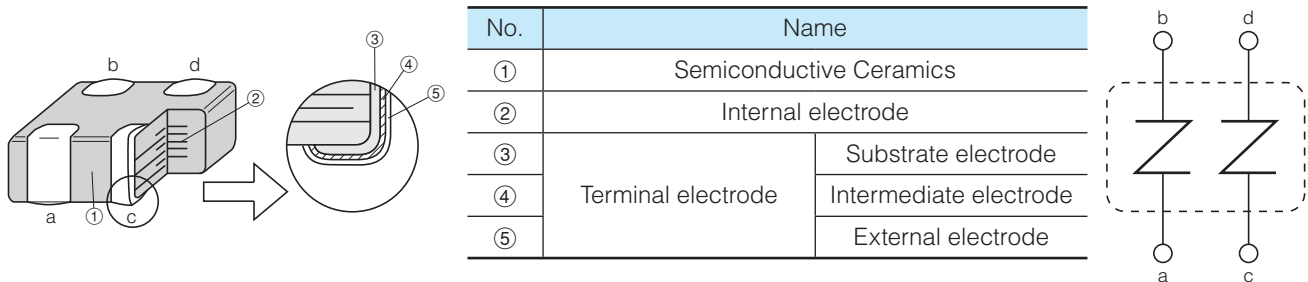

Dimensions in mm (not to scale)

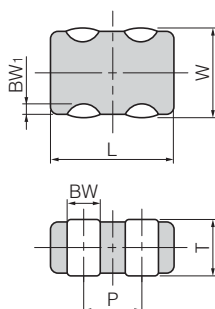

Size(inch)	L	W	T	BW	BW ₁	P
0504 (2 Array)	1.37±0.15	1.0±0.1	0.60 ^{+0.06} _{-0.10}	0.36±0.10	0.2±0.1	0.64±0.10

Ratings and Characteristics

Size	Part No.	Maximum allowable voltage DC (V)	Nominal varistor voltage at 1mA (V)	Capacitance (pF)		Maximum peak current at 8/20μs, 2times (A)	Maximum ESD IEC61000-4-2
				at 1MHz	at 1kHz		
0504 (2 Array)	EZJZSV120JA	6.7	12	220 max. [150 typ.]	175 typ.	5	Contact discharge 8 kV
	EZJZSV270EA	16	27	47 max. [33 typ.]	37 typ.	5	
	EZJZSV270RA	16	27	20 max. [15 typ.]	16.5 typ.	3	
	EZJZSV270DA□	16	27	27±10 %/±20 %	30 typ.	5	
	EZJZSV270PA□	16	27	33±10 %/±20 %	37 typ.	5	
	EZJZSV270SA□	16	27	39±10 %/±20 %	43 typ.	5	
	EZJZSV270TA□	16	27	43±10 %/±20 %	47 typ.	5	
	EZJZSV270EA□	16	27	47±10 %/±20 %	52 typ.	5	
	EZJZSV500AA	5	50	3 max. [2.1 typ.]	—	—	
	EZJZSV800AA	18	80	3 max. [2.1 typ.]	—	—	
EZJZSV171AA	18	170	3 max. [2.1 typ.]	—	—		

- Operating Temperature Range: -40 to 85 °C
- * □ : Capacitance Tolerance Code K:±10 %, M:±20 %
- * Avoid flow soldering.

Voltage vs. Current

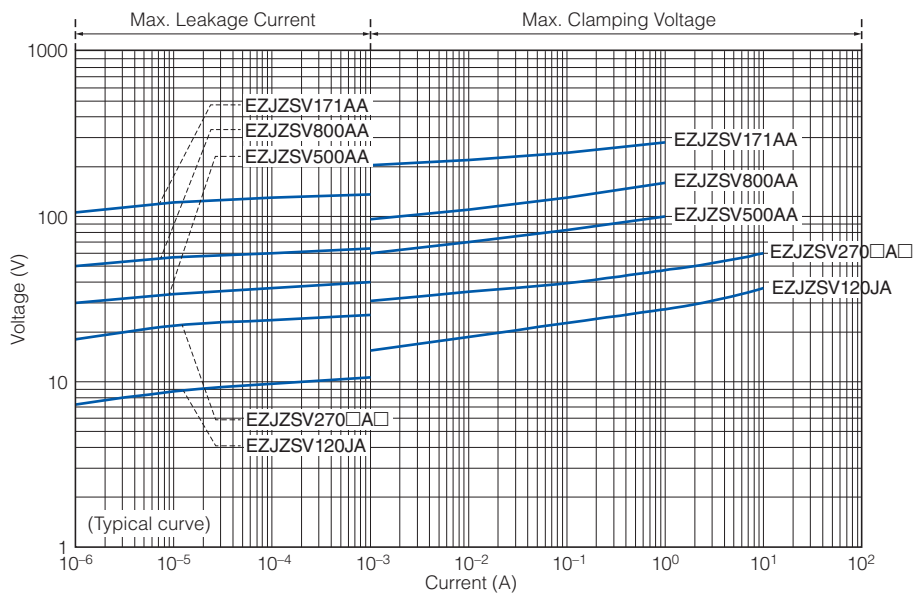

Frequency vs. Capacitance

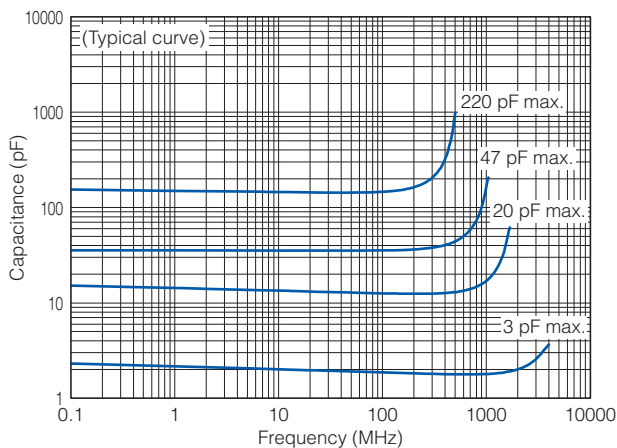

Attenuation vs. Frequency

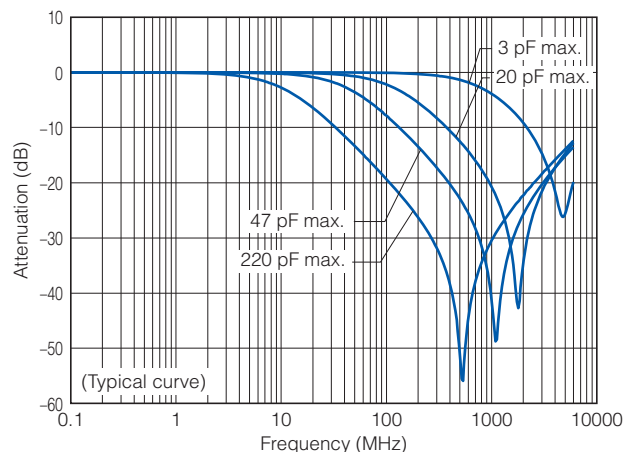

Varistor Characteristics and Equivalent Circuit

A Multilayer Varistor does not have an electrical polarity like zener diodes and is equivalent to total 3 pcs. of 2 zener diodes and 1 capacitor.

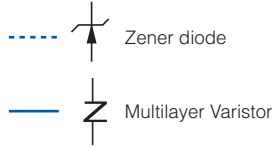
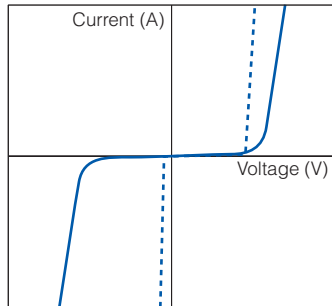

[Equivalent Circuit]

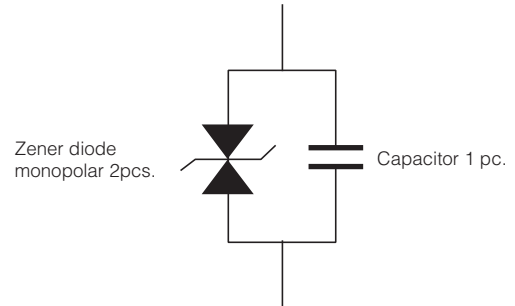

ESD Suppressive Effects

Typical effects of ESD suppression

Test conditions: IEC61000-4-2* Level 4 Contact discharge, 8 kV

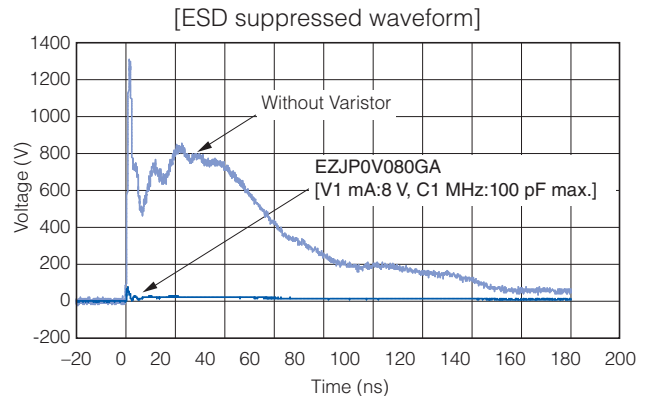
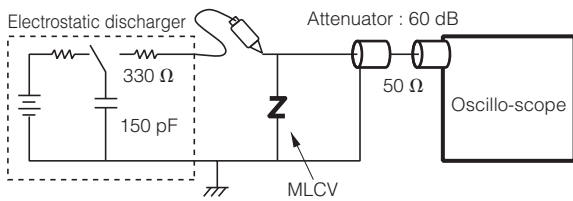

* IEC61000-4-2 ... International Standard of the ESD testing method (HBM) for electronic equipment ability to withstand ESD generated from a human body. It sets 4 levels of severity

Severity	Level 1	Level 2	Level 3	Level 4
Contact discharge	2 kV	4 kV	6 kV	8 kV
Air discharge	2 kV	4 kV	8 kV	15 kV

Replacement of Zener diode

Replacing "Zener diode and Capacitor" with Multilayer Varistor saves both the mounting area and number of components used.

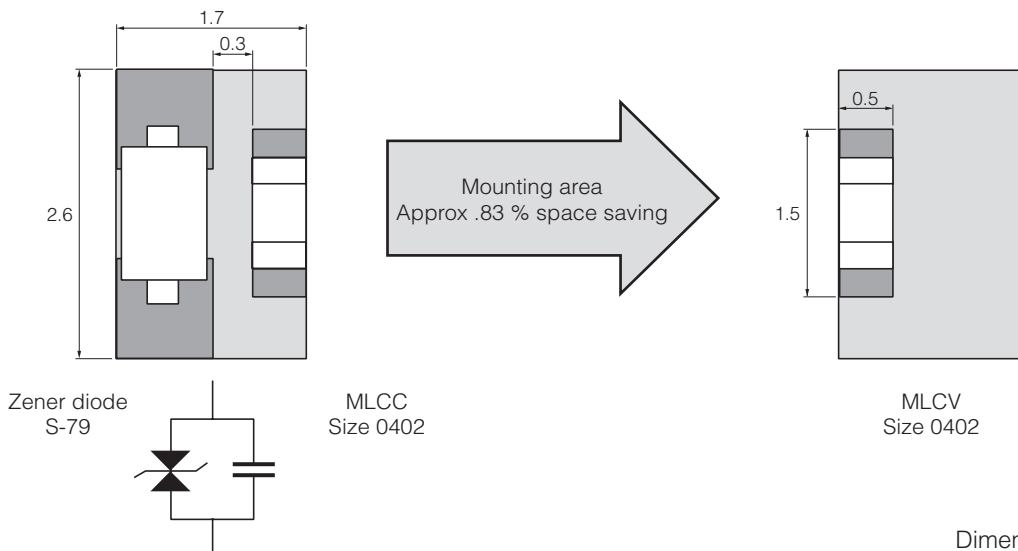

Dimensions in mm

Recommended Applications

Applications	Series	Circuit	Series			
			DC	1k	1M	1G (Hz)
Mobile phones, DSC, PC, PDA, HDD TV (PDP, LC etc.), DVD, DVC, Game consoles, Audio equipment	Series EZJZ, P	Ultra low capacitance (Cap. : 3 pF or less)	[Bar chart showing high performance at high frequencies]			DC to GHz Antenna, RF circuit, LVDS, USB, IEEE1394, HDMI etc.
		Low capacitance (Cap. : 20 to 680 pF)	[Bar chart showing performance at mid frequencies]			DC to tens of Hz PWR, SW, Audio terminals, LCD, RS232C, etc.
PWR, Photoelectric sensors, SSR, Motors, Pressure sensors, Proximity switches	Series EZJS	High capacitance (Cap. : 1800 to 22000 pF)	[Bar chart showing performance at low frequencies]			DC to several kHz PWR, SW, Audio terminals etc.

Applications

● Mobile Phone

· Audio lines

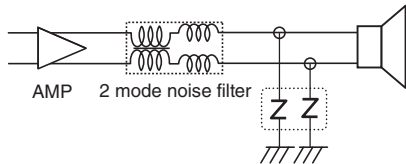

· LED

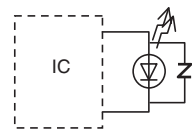

· SW/Keyboard

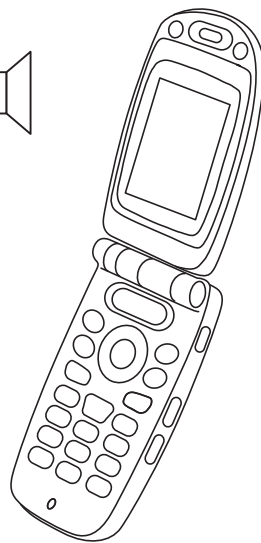
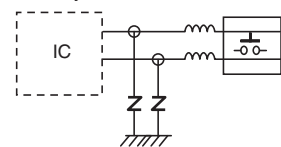

· LCD/Camera lines

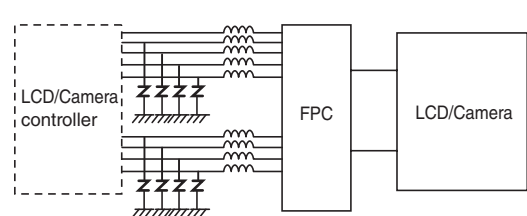

· I/O data lines

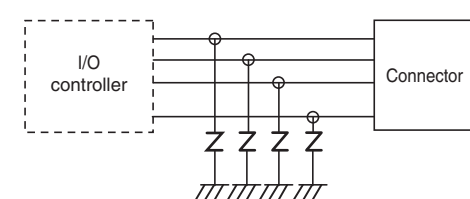

● USB1.1/2.0 lines

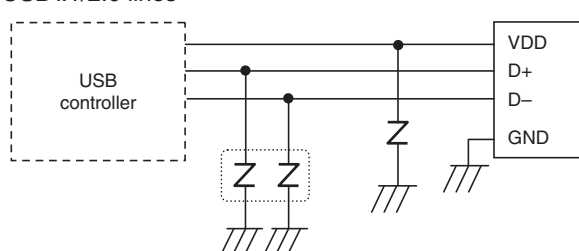

● IEEE1394 lines

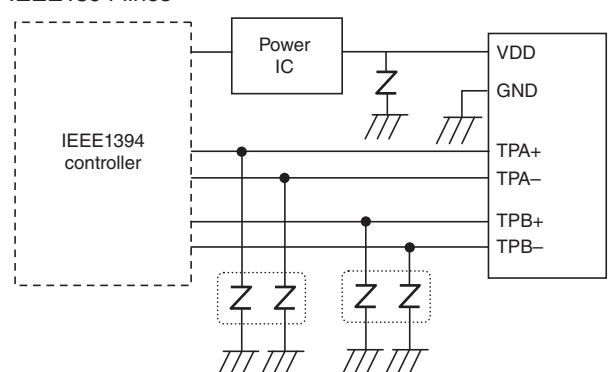

● HDMI lines

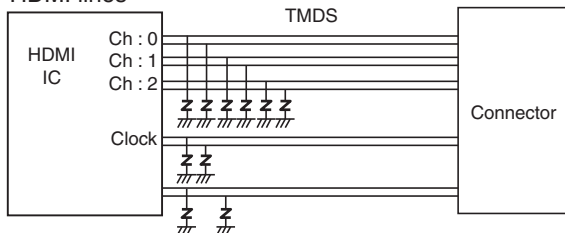

Performance and Testing Methods

Characteristics	Specifications	Testing Method															
Standard test conditions		Electrical characteristics shall be measured under the following conditions. Temp. : 5 to 35 °C, Relative humidity : 85 % or less															
Varistor voltage	To meet the specified value.	The Varistor voltage is the voltage (V_c , or V_{cMA}) between both end terminals of a Varistor when specified current (C_{mA}) is applied to it. The measurement shall be made as quickly as possible to avoid heating effects.															
Maximum allowable voltage	To meet the specified value.	The maximum DC voltage that can be applied continuously to a varistor															
Capacitance	To meet the specified value.	Capacitance shall be measured at the specified frequency, bias voltage 0 V, and measuring voltage 0.2 to 2 Vrms.															
Maximum peak current	To meet the specified value.	The maximum current measured (Varistor voltage tolerance is within $\pm 10\%$) when a standard impulse current of $8/20 \mu$ seconds is applied twice with an interval of 5 minutes.															
Maximum ESD	To meet the specified value.	The maximum ESD measured (while the varistor voltage is within $\pm 30\%$ of its nominal value) when exposed to ESD 10 times (five times for each positive-negative polarity) based on IEC61000-4-2.															
Solder ability	To meet the specified value.	The part shall be immersed into a soldering bath under the conditions below. Solder: H63A Soldering flux : Ethanol solution of rosin (Concentration approx. 25 wt%) Soldering temp. : 230 ± 5 °C Period : 4 ± 1 s Soldering position: Immerse both terminal electrodes until they are completely into the soldering bath.															
Resistance to soldering heat	$\Delta V_c / V_c$: within $\pm 10\%$	After the immersion, leave the part for 24 ± 2 hours under the standard condition, then evaluate its characteristics. Soldering conditions are specified below: Soldering conditions : 270 °C, 3 s / 260 °C, 10 s Soldering position : Immerse both terminal electrodes until they are completely into the soldering bath.															
Temperature cycling	$\Delta V_c / V_c$: within $\pm 10\%$	After repeating the cycles stated below for specified number of times, leave the part for 24 ± 2 hours, then evaluate its characteristics. Cycle : 5 cycles <table border="1" style="margin-left: auto; margin-right: auto;"> <thead> <tr> <th>Step</th> <th>Temperature</th> <th>Period</th> </tr> </thead> <tbody> <tr> <td>1</td> <td>Max. Operating Temp.</td> <td>30 ± 3 min</td> </tr> <tr> <td>2</td> <td>Ordinary temp.</td> <td>3 min max.</td> </tr> <tr> <td>3</td> <td>Min. Operating Temp.</td> <td>30 ± 3 min</td> </tr> <tr> <td>4</td> <td>Ordinary temp.</td> <td>3 min max.</td> </tr> </tbody> </table>	Step	Temperature	Period	1	Max. Operating Temp.	30 ± 3 min	2	Ordinary temp.	3 min max.	3	Min. Operating Temp.	30 ± 3 min	4	Ordinary temp.	3 min max.
Step	Temperature	Period															
1	Max. Operating Temp.	30 ± 3 min															
2	Ordinary temp.	3 min max.															
3	Min. Operating Temp.	30 ± 3 min															
4	Ordinary temp.	3 min max.															
Biased Humidity	$\Delta V_c / V_c$: within $\pm 10\%$	After conducting the test under the conditions specified below, leave the part 24 ± 2 hours, then evaluate its characteristics. Temp. : 40 ± 2 °C Humidity : 90 to 95 %RH Applied voltage : Maximum allowable voltage (Individually specified) Period : $500 + 24 / 0$ h															
High temperature exposure (dry heat)	$\Delta V_c / V_c$: within $\pm 10\%$	After conducting the test under the conditions specified below, leave the part 24 ± 2 hours, then evaluate its characteristics. Temp. : Maximum operating temperature ± 3 °C (Individually specified) Applied voltage : Maximum allowable voltage (Individually specified) Period : $500 + 24 / 0$ h															

Mouser Electronics

Authorized Distributor

Click to View Pricing, Inventory, Delivery & Lifecycle Information:

Panasonic:

[EZJ-ZSV120JA](#) [EZJ-ZSV171AA](#) [EZJ-ZSV270DAK](#) [EZJ-ZSV270DAM](#) [EZJ-ZSV270EA](#) [EZJ-ZSV270EAK](#) [EZJ-ZSV270EAM](#) [EZJ-ZSV270PAK](#) [EZJ-ZSV270PAM](#) [EZJ-ZSV270RA](#) [EZJ-ZSV270SAK](#) [EZJ-ZSV270SAM](#) [EZJ-ZSV270TAK](#) [EZJ-ZSV270TAM](#) [EZJ-ZSV500AA](#)