

### 2W Detector Switches

Type: **ESE24**

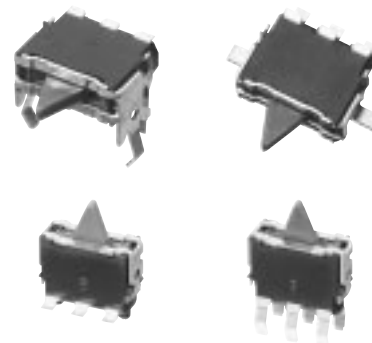

Bidirectional operation, auto-return to midpoint type.

#### ■ Features

- A lever-type detector switch with high reliability using sliding mechanical contacts
- Long over-travel (through-operation available)
- Used as an operation switch (an input device)

#### ■ Recommended Applications

- Detection of media in portable electronic equipment (CD-ROM, DVD, Digital still cameras, etc.)
- Operating switches for other electronic equipment.

#### ■ Explanation of Part Number

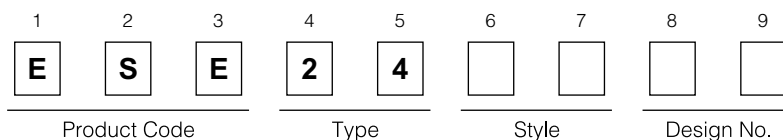

6th & 7th	Mounting Method & Style
SV	Vertical type for wave soldering
SH	Horizontal type for wave soldering
MV	Vertical type for reflow soldering
MH	Horizontal type for reflow soldering

#### ■ Specifications

Rating	50 $\mu$ A 3 Vdc to 10 mA 5 Vdc (Resistive load)	
Contact Resistance	500 m $\Omega$ max. (Initial)	
Insulation Resistance	100 M $\Omega$ min. (100 Vdc)	
Dielectric Withstanding Voltage	100 Vac for 1 minute	
Operating Force	350 mN max.	
Mounting Height	<ul style="list-style-type: none"> <li>· Type SV 5.6 mm</li> <li>· Type SH 4.65 mm</li> <li>· Type MV 5.6 mm</li> <li>· Type MH 3.0 mm</li> </ul>	
Poles and Throws	1-pole 2-throws (OFF at midpoint)	
Full Travel (Pushing distance)	<ul style="list-style-type: none"> <li>· Type SV 6.1 mm (2.45 mm)</li> <li>· Type SH 2.6 mm (2.45 mm)</li> <li>· Type MV 6.1 mm (2.45 mm)</li> <li>· Type MH 1.4 mm (2.45 mm)</li> </ul>	
Operating Life	50000 cycles min.	
Temperature Range	-10 °C to +70 °C	
Heat Resistance	+80 °C for 96 hours	
Low Temperature Resistance	-25 °C for 96 hours	
Humidity Resistance	+40 °C 90 % to 95 % RH for 96 hours	
Minimum Quantity/Packing Unit	ESE24MH, MV, SV, SH	200 pcs. Polyethylene Bag (Bulk) *1
	ESE24MH□T	1000 pcs. Embossed Taping (Reel Pack) *2
	ESE24MV□T	500 pcs. Embossed Taping (Reel Pack)
Quantity/Carton	ESE24MH, MV, SV, SH	10000 pcs. Polyethylene Bag (Bulk)
	ESE24MH□T	6000 pcs. Embossed Taping (Reel Pack)
	ESE24MV□T	3000 pcs. Embossed Taping (Reel Pack)

\*1 ESE24SH type: 160 pcs. (Polyethylene Bag), 8000 pcs. (Reel Pack)  
 \*2 ESE24SV, ESE24SH are excluded

Design and specifications are each subject to change without notice. Ask factory for the current technical specifications before purchase and/or use.  
 Should a safety concern arise regarding this product, please be sure to contact us immediately.

■ Dimensions in mm (not to scale)

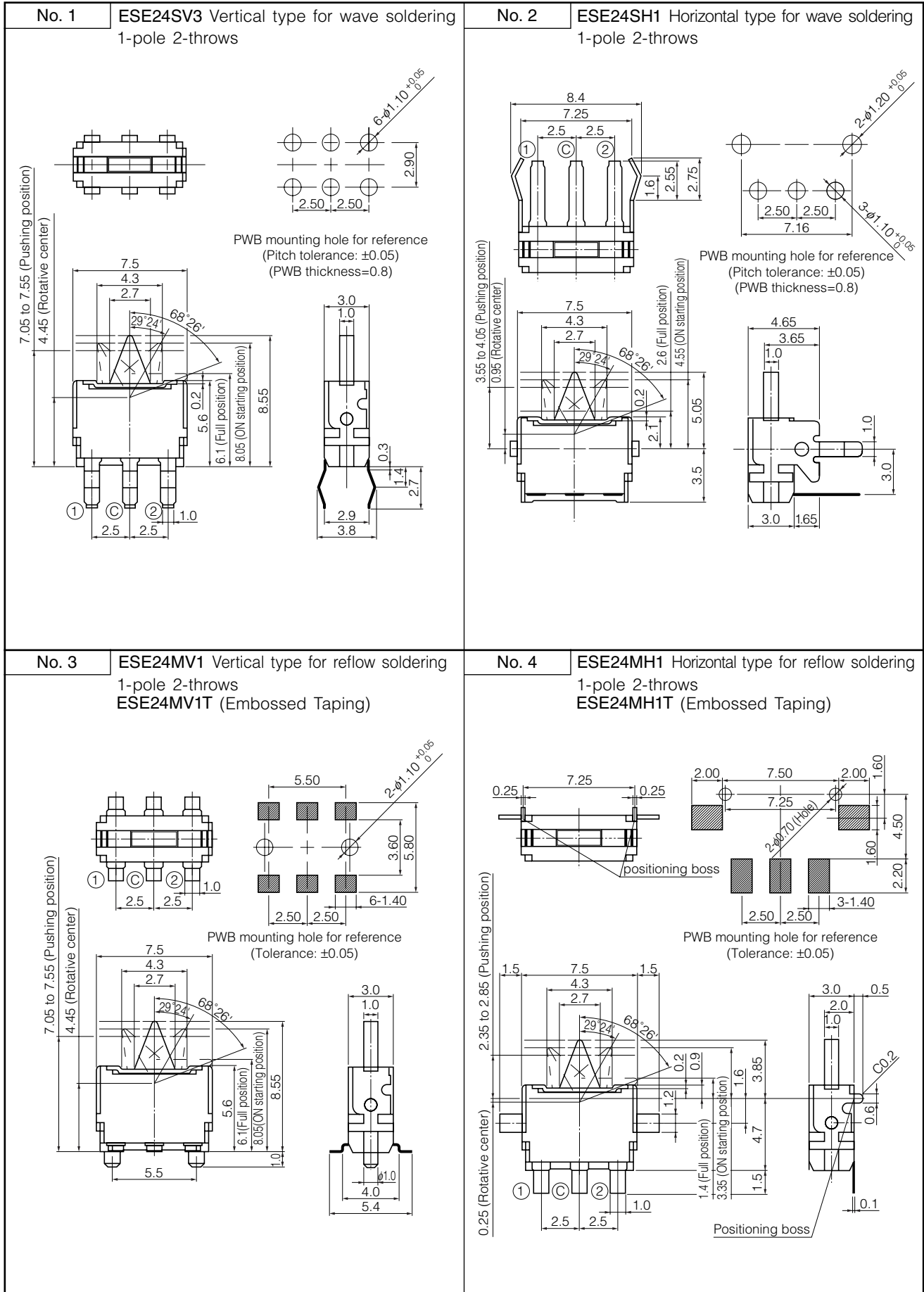

Design and specifications are each subject to change without notice. Ask factory for the current technical specifications before purchase and/or use.  
Should a safety concern arise regarding this product, please be sure to contact us immediately.

### ■ Circuit Diagram

1-pole 2-throws (N . O)

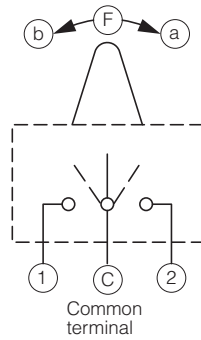

Terminal No. Lever position	①	③	②
ⓕ		○	
ⓐ	○	○	
ⓑ		○	○

### ■ Packaging Specifications

Standard Reel Dimensions in mm (not to scale)

#### Taping Reel

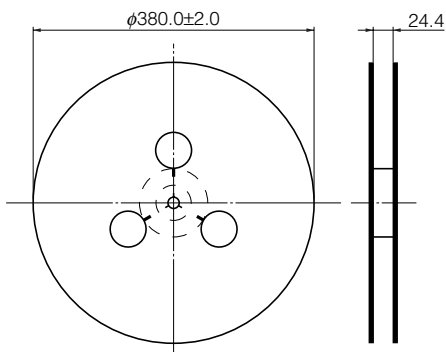

#### Embossed Carrier Taping

ESE24MH□T

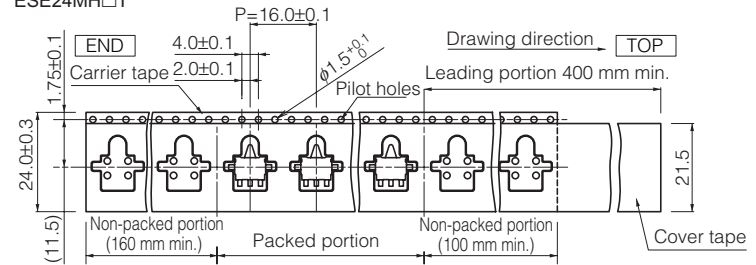

ESE24MV□T

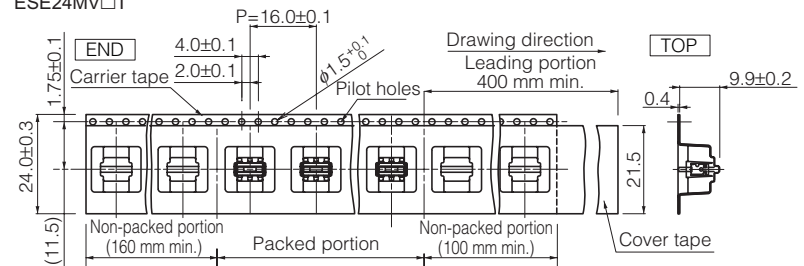

# Mouser Electronics

Authorized Distributor

Click to View Pricing, Inventory, Delivery & Lifecycle Information:

[Panasonic:](#)

[ESE-24CMV1TEE](#) [ESE-24MH1T](#) [ESE-24MV1](#) [ESE-24SH1](#) [ESE-24SV3](#) [ESE-24CMV6T](#) [ESE-24CMV9T](#)