

## GENERAL ELECTRICAL & MECHANICAL SPECIFICATION

### GENERAL FEATURES

- AVAILABLE IN 1,2,3,4,12 & 16 WAY
- LED ILLUMINATED & NON-ILLUMINATED
- ROBUST RELIABLE SMOOTH KEY ACTION
- SEALED TO IP 65
- IMPACT TESTED TO IK 07
- KEY LIFE OF OVER 2 MILLION CYCLES
- FRONT OR REAR MOUNT ASSEMBLY
- FRONT BEZEL FOR HIDDEN FIXINGS
- SIMPLE CONNECTION TO MALE 0.1" PITCH HEADER
- MATT BLACK, MATT GREY, BRUSHED CHROME KEY – BEZEL – BASEPLATE COMBINATION



**MATT BLACK with BLUE LED**

#### ELECTRICAL

Contact Rating	20mA @ 24Vdc (max)
Breakdown Voltage	500V AC (max )
Insulation Resistance	50 Mohms (min)
Contact Resistance	200Ω (max)
Contact Bounce	< 5ms

LED (total illuminated) Typ (not individually switchable)	If = 30mA max @ 24V (resistor dependant)
---	--

#### MECHANICAL

Operational Life	>2,000,000 Cycles per key
Key Travel (stroke)	1.5mm +/- 0.2mm
Actuating Force	120+/-30gms
Connector	0.1" pitch, square pin, Male connector

#### MATERIAL

Casing	Powder-Coated Die Cast Zinc
Keys	Powder-Coated Die Cast Zinc
Contact Circuit	Gold on Nickel plated FR4

#### ENVIRONMENTAL

Water / Dust Sealed	IP 65 (When mounted to suitable enclosure)
Operating Temp (non-illum)	-40°C to +80 °C (dry)
Operating Temp (illum)	-40°C to +80 °C (dry)
Impact	IK 07

#### ACCESSORIES

Bezel	Powder-Coated Die Cast Zinc
Keypads Customised	Legends

#### CUSTOMER OPTIONS

Choose 1 option per category

1. Casing Colour Matt Grey / Brushed Chrome / Matt Black
2. Key Format Telephone / Calculator / Customer
3. Key Colour Matt Grey / Brushed Chrome / Matt Black
4. Key Legends For options contact Lorlin Sales
5. Illuminated Keys Required / NOT Required
6. Key Colours Blue / Red / Green / White / Yellow
7. Rear Mounting Bezel & Gasket Part Number ---- KPF



**BRUSHED CHROME NON-ILLUMINATED**



**MATT GREY with GREEN LED**

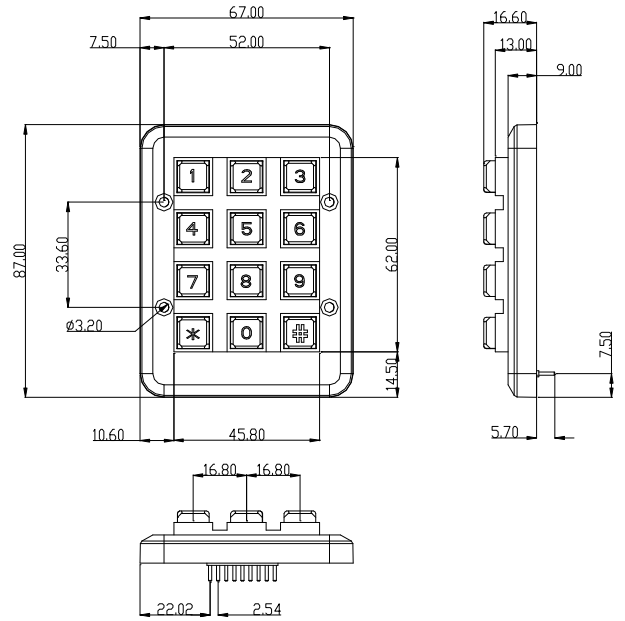
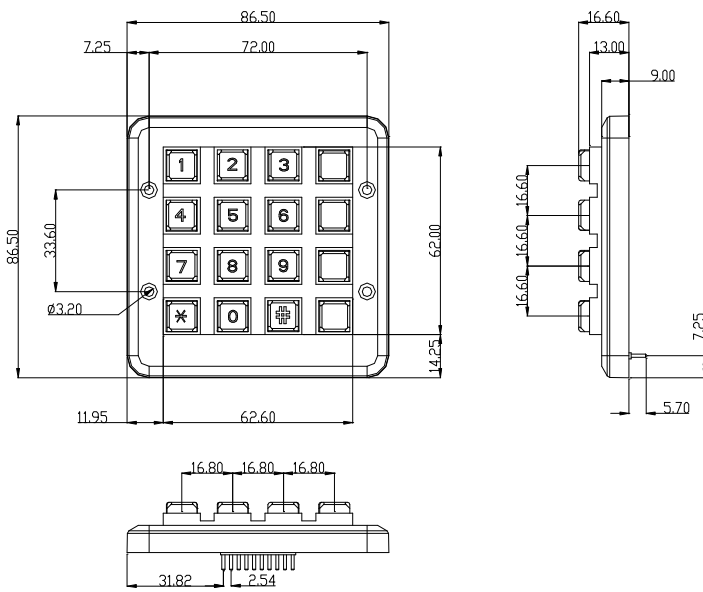

Output Arrangement	
Output pin	Symbol
1	TBA
2	TBA
3	ROW2
4	ROW3
5	COL1
6	ROW4
7	COL2
8	COL3
9	COL4
10	ROW1

Output Arrangement	
Output pin	Symbol
1	TBA
2	TBA
3	COL 2
4	ROW 1
5	COL 1
6	ROW 4
7	COL 3
8	ROW 3
9	ROW 2

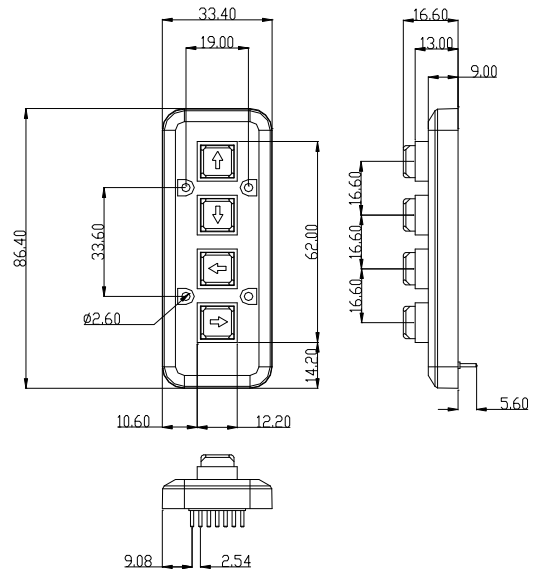
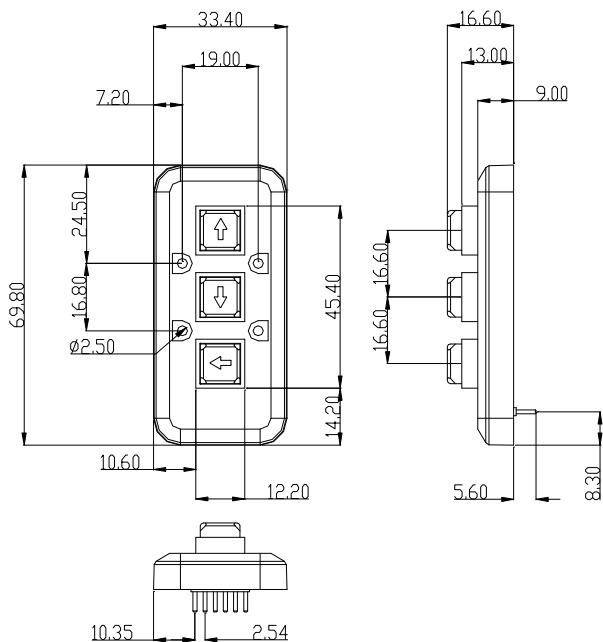

Output Arrangement	
Output pin	Symbol
1	TBA
2	TBA
3	ROW1
4	ROW2
5	ROW3
6	COL1

Output Arrangement	
Output pin	Symbol
1	TBA
2	TBA
3	ROW1
4	ROW2
5	ROW3
6	ROW4
7	COL 1

Output Arrangement	
Output pin number	Symbol
1	TBA
2	TBA
3	COL 1
4	ROW 1

Output Arrangement	
Output pin number	Symbol
1	TBA
2	TBA
3	ROW 1
4	ROW 2
5	COL 1

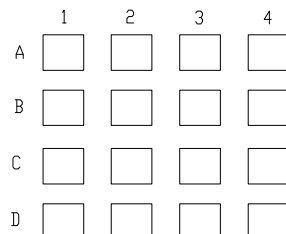
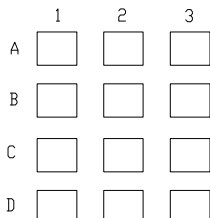
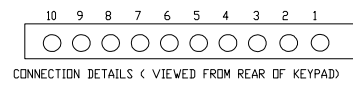
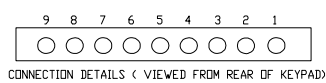
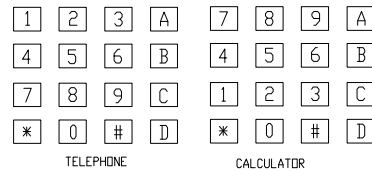
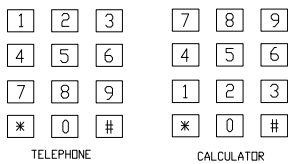
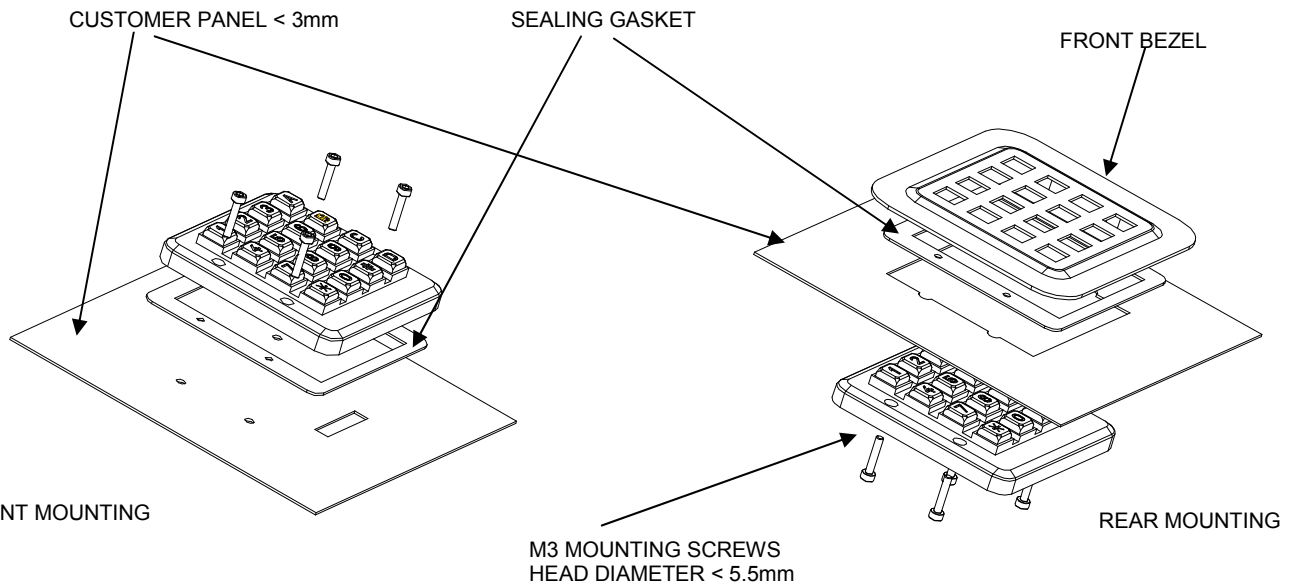
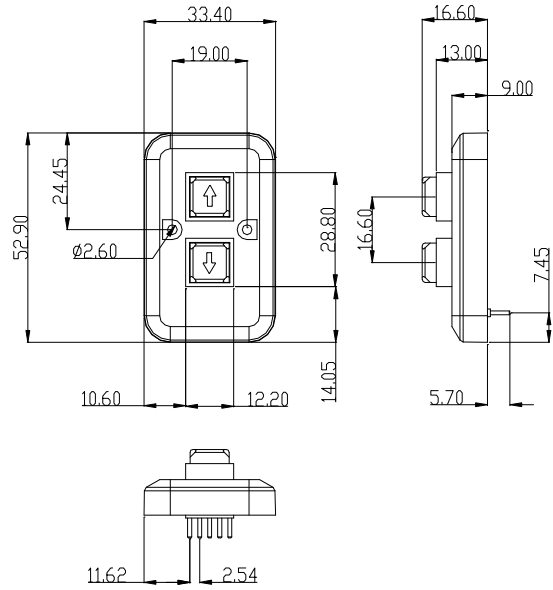
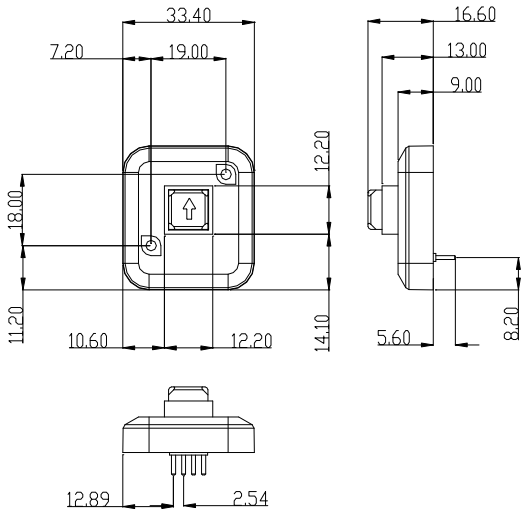

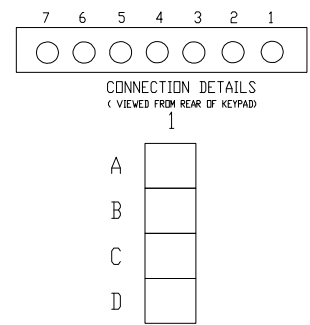
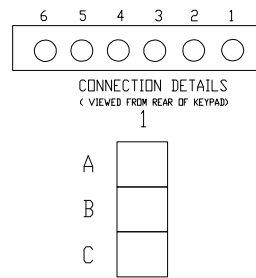
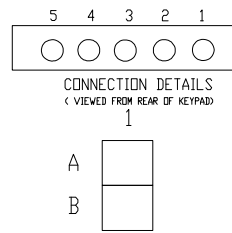
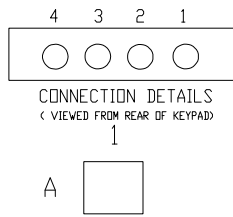

## STANDARD PART NUMBERS

CASE KEY AND FRONT BEZEL COLOUR	MATT GREY	MATT BLACK	BRUSH CHROME
12 WAY 3X4 FRONT BEZEL + GASKET	KPF1201	KPF1202	KPF1203
12 Way 3X4 KEY PAD			
TELEPHONE NON ILLUMINATED	KP120001	KP120002	KP120003
TELEPHONE ILLUMINATED BLUE	KP120005	KP120006	KP120007
TELEPHONE ILLUMINATED RED	KP120009	KP120010	KP120011
TELEPHONE ILLUMINATED GREEN	KP120013	KP120014	KP120015
TELEPHONE ILLUMINATED WHITE	KP120017	KP120018	KP120019
TELEPHONE ILLUMINATED YELLOW	KP120021	KP120022	KP120023
CALCULATOR NON ILLUMINATED	KP120025	KP120026	KP120027
CALCULATOR ILLUMINATED BLUE	KP120029	KP120030	KP120031
CALCULATOR ILLUMINATED RED	KP120033	KP120034	KP120035
CALCULATOR ILLUMINATED GREEN	KP120037	KP120038	KP120039
CALCULATOR ILLUMINATED WHITE	KP120041	KP120042	KP120043
CALCULATOR ILLUMINATED YELLOW	KP120045	KP120046	KP120047
16 WAY 4X4 FRONT BEZEL + GASKET	KPF1601	KPF1602	KPF1603
16 WAY 4x4 KEY PAD			
TELEPHONE NON ILLUMINATED	KP160001	KP160002	KP160003
TELEPHONE ILLUMINATED BLUE	KP160005	KP160006	KP160007
TELEPHONE ILLUMINATED RED	KP160009	KP160010	KP160011
TELEPHONE ILLUMINATED GREEN	KP160013	KP160014	KP160015
TELEPHONE ILLUMINATED WHITE	KP160017	KP160018	KP160019
TELEPHONE ILLUMINATED YELLOW	KP160021	KP160022	KP160023
CALCULATOR ILLUMINATED BLUE	KP160025	KP160026	KP160027
CALCULATOR ILLUMINATED RED	KP160029	KP160030	KP160031
CALCULATOR ILLUMINATED GREEN	KP160033	KP160034	KP160035
CALCULATOR ILLUMINATED WHITE	KP160037	KP160038	KP160039
CALCULATOR ILLUMINATED YELLOW	KP160041	KP160042	KP160043
4 WAY 1X4 KEY PAD	KP040001	KP040002	KP040003
ARROW NON ILLUMINATED	KP040005	KP040006	KP040007
ARROW ILLUMINATED BLUE	KP040009	KP040010	KP040011
ARROW ILLUMINATED RED	KP040013	KP040014	KP040015
ARROW ILLUMINATED GREEN	KP040017	KP040018	KP040019
ARROW ILLUMINATED WHITE	KP040021	KP040022	KP040023
ARROW ILLUMINATED YELLOW	KP040025	KP040026	KP040027
3 WAY 1X3 KEY PAD	KP030001	KP030002	KP030003
ARROW NON ILLUMINATED	KP030005	KP030006	KP030007
ARROW ILLUMINATED BLUE	KP030009	KP030010	KP030011
ARROW ILLUMINATED RED	KP030013	KP030014	KP030015
ARROW ILLUMINATED GREEN	KP030017	KP030018	KP030019
ARROW ILLUMINATED WHITE	KP030021	KP030022	KP030023
ARROW ILLUMINATED YELLOW	KP030025	KP030026	KP030027
2 WAY 1X2 KEY PAD	KP020001	KP020002	KP020003
ARROW NON ILLUMINATED	KP020005	KP020006	KP020007
ARROW ILLUMINATED BLUE	KP020009	KP020010	KP020011
ARROW ILLUMINATED RED	KP020013	KP020014	KP020015
ARROW ILLUMINATED GREEN	KP020017	KP020018	KP020019
ARROW ILLUMINATED WHITE	KP020021	KP020022	KP020023
ARROW ILLUMINATED YELLOW	KP020025	KP020026	KP020027
1 WAY KEY	KP010001	KP010002	KP010003
ARROW NON ILLUMINATED	KP010005	KP010006	KP010007
ARROW ILLUMINATED BLUE	KP010009	KP010010	KP010011
ARROW ILLUMINATED RED	KP010013	KP010014	KP010015
ARROW ILLUMINATED GREEN	KP010017	KP010018	KP010019
ARROW ILLUMINATED WHITE	KP010021	KP010022	KP010023
ARROW ILLUMINATED YELLOW	KP010025	KP010026	KP010027

# Mouser Electronics

Authorized Distributor

Click to View Pricing, Inventory, Delivery & Lifecycle Information:

[Lorlin:](#)

[KP120005](#) [KP160005](#) [KPF1201](#) [KPF1601](#)