

**NPN Silicon RF Transistor\***

- For low noise, low distortion broadband amplifiers in antenna and telecommunications systems up to 1.5 GHz at collector currents from 20 mA to 80 mA
- Power amplifier for DECT and PCN systems
- $f_T = 7.5$  GHz,  $F = 1.3$  dB at 900 MHz
- Pb-free (RoHS compliant) package<sup>1)</sup>
- Qualified according AEC Q101

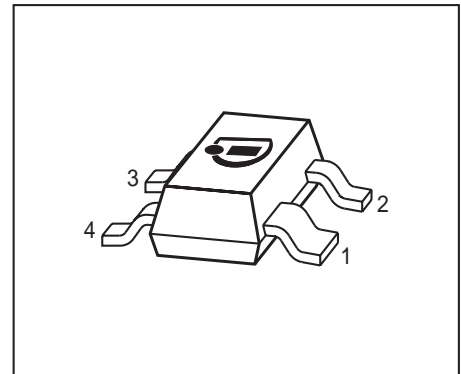

\* Short term description



**ESD (Electrostatic discharge) sensitive device, observe handling precaution!**

Type	Marking	Pin Configuration						Package
BFP196	RIs	1 = C	2 = E	3 = B	4 = E	-	-	SOT143

**Maximum Ratings**

Parameter	Symbol	Value	Unit
Collector-emitter voltage	$V_{CEO}$	12	V
Collector-emitter voltage	$V_{CES}$	20	
Collector-base voltage	$V_{CBO}$	20	
Emitter-base voltage	$V_{EBO}$	2	
Collector current	$I_C$	150	mA
Base current	$I_B$	15	
Total power dissipation <sup>2)</sup> $T_S \leq 77^\circ\text{C}$	$P_{tot}$	700	mW
Junction temperature	$T_j$	150	°C
Ambient temperature	$T_A$	-65 ... 150	
Storage temperature	$T_{stg}$	-65 ... 150	

**Thermal Resistance**

Parameter	Symbol	Value	Unit
Junction - soldering point <sup>3)</sup>	$R_{thJS}$	$\leq 105$	K/W

<sup>1</sup>Pb-containing package may be available upon special request

<sup>2</sup> $T_S$  is measured on the collector lead at the soldering point to the pcb

<sup>3</sup>For calculation of  $R_{thJA}$  please refer to Application Note Thermal Resistance

**Electrical Characteristics** at  $T_A = 25^\circ\text{C}$ , unless otherwise specified

Parameter	Symbol	Values			Unit
		min.	typ.	max.	
<b>DC Characteristics</b>					
Collector-emitter breakdown voltage $I_C = 1 \text{ mA}, I_B = 0$	$V_{(BR)CEO}$	12	-	-	V
Collector-emitter cutoff current $V_{CE} = 20 \text{ V}, V_{BE} = 0$	$I_{CES}$	-	-	100	$\mu\text{A}$
Collector-base cutoff current $V_{CB} = 10 \text{ V}, I_E = 0$	$I_{CBO}$	-	-	100	nA
Emitter-base cutoff current $V_{EB} = 1 \text{ V}, I_C = 0$	$I_{EBO}$	-	-	1	$\mu\text{A}$
DC current gain- $I_C = 50 \text{ mA}, V_{CE} = 8 \text{ V}, \text{ pulse measured}$	$h_{FE}$	70	100	140	-

**Electrical Characteristics at  $T_A = 25^\circ\text{C}$ , unless otherwise specified**

Parameter	Symbol	Values			Unit
		min.	typ.	max.	
<b>AC Characteristics (verified by random sampling)</b>					
Transition frequency $I_C = 70\text{ mA}$ , $V_{CE} = 8\text{ V}$ , $f = 500\text{ MHz}$	$f_T$	5	7.5	-	GHz
Collector-base capacitance $V_{CB} = 10\text{ V}$ , $f = 1\text{ MHz}$ , $V_{BE} = 0$ , emitter grounded	$C_{cb}$	-	0.83	1.3	pF
Collector emitter capacitance $V_{CE} = 10\text{ V}$ , $f = 1\text{ MHz}$ , $V_{BE} = 0$ , base grounded	$C_{ce}$	-	0.35	-	
Emitter-base capacitance $V_{EB} = 0.5\text{ V}$ , $f = 1\text{ MHz}$ , $V_{CB} = 0$ , collector grounded	$C_{eb}$	-	3.9	-	
Noise figure $I_C = 20\text{ mA}$ , $V_{CE} = 8\text{ V}$ , $Z_S = Z_{Sopt}$ , $f = 900\text{ MHz}$ $I_C = 20\text{ mA}$ , $V_{CE} = 8\text{ V}$ , $Z_S = Z_{Sopt}$ , $f = 1.8\text{ GHz}$	$F$	-	1.3	-	dB
		-	2.3	-	
Power gain, maximum available <sup>1)</sup> $I_C = 50\text{ mA}$ , $V_{CE} = 8\text{ V}$ , $Z_S = Z_{Sopt}$ , $Z_L = Z_{Lopt}$ , $f = 900\text{ MHz}$ $I_C = 50\text{ mA}$ , $V_{CE} = 8\text{ V}$ , $Z_S = Z_{Sopt}$ , $Z_L = Z_{Lopt}$ , $f = 1.8\text{ GHz}$	$G_{ma}$	-	16.5	-	
		-	10.5	-	
Transducer gain $I_C = 50\text{ mA}$ , $V_{CE} = 8\text{ V}$ , $Z_S = Z_L = 50\Omega$ , $f = 900\text{ MHz}$ $I_C = 50\text{ mA}$ , $V_{CE} = 8\text{ V}$ , $Z_S = Z_L = 50\Omega$ , $f = 1.8\text{ GHz}$	$ S_{21e} ^2$	-	13	-	dB
		-	7	-	

<sup>1)</sup>  $G_{ma} = |S_{21} / S_{12}| (k - (k^2 - 1)^{1/2})$

**SPICE Parameter (Gummel-Poon Model, Berkley-SPICE 2G.6 Syntax):**
**Transistor Chip Data:**

IS =	1.7264	fA	BF =	125	-	NF =	0.80012	-
VAF =	20	V	IKF =	0.4294	A	ISE =	119.22	fA
NE =	1.1766	-	BR =	10.584	-	NR =	0.94288	-
VAR =	3.8128	V	IKR =	0.019551	A	ISC =	4.8666	fA
NC =	0.88299	-	RB =	1.2907	$\Omega$	IRB =	0.084011	mA
RBM =	1	$\Omega$	RE =	0.75103	-	RC =	0.27137	$\Omega$
CJE =	13.325	fF	VJE =	0.7308	V	MJE =	0.33018	-
TF =	23.994	ps	XTF =	0.44322	-	VTF =	0.1	V
ITF =	1.9775	mA	PTF =	0	deg	CJC =	1667	fF
VJC =	0.73057	V	MJC =	0.3289	-	XCJC =	0.29998	-
TR =	2.2413	ns	CJS =	0	fF	VJS =	0.75	V
MJS =	0	-	NK =	0	-	EG =	1.11	eV
XTI =	3	-	FC =	0.50922	-	TNOM	300	K

All parameters are ready to use, no scaling is necessary. Extracted on behalf of Infineon Technologies AG by: Institut für Mobil- und Satellitentechnik (IMST)

**Package Equivalent Circuit:**

$L_{BI}$ =	0.84	nH
$L_{BO}$ =	0.65	nH
$L_{EI}$ =	0.31	nH
$L_{EO}$ =	0.14	nH
$L_{CI}$ =	0.07	nH
$L_{CO}$ =	0.42	nH
$C_{BE}$ =	145	fF
$C_{CB}$ =	19	fF
$C_{CE}$ =	281	fF

Valid up to 6GHz

For examples and ready to use parameters please contact your local Infineon Technologies distributor or sales office to obtain a Infineon Technologies CD-ROM or see Internet: <http://www.infineon.com>

**Total power dissipation  $P_{tot} = f(T_S)$**

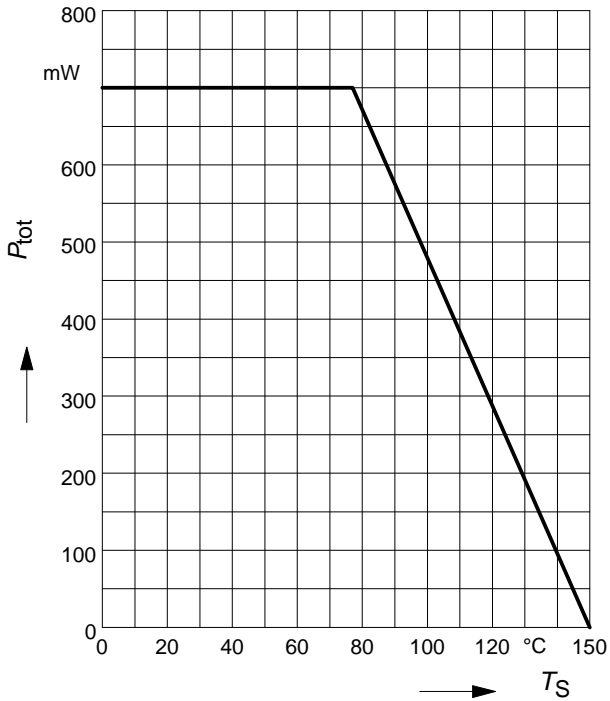

**Permissible Pulse Load  $R_{thJS} = f(t_p)$**

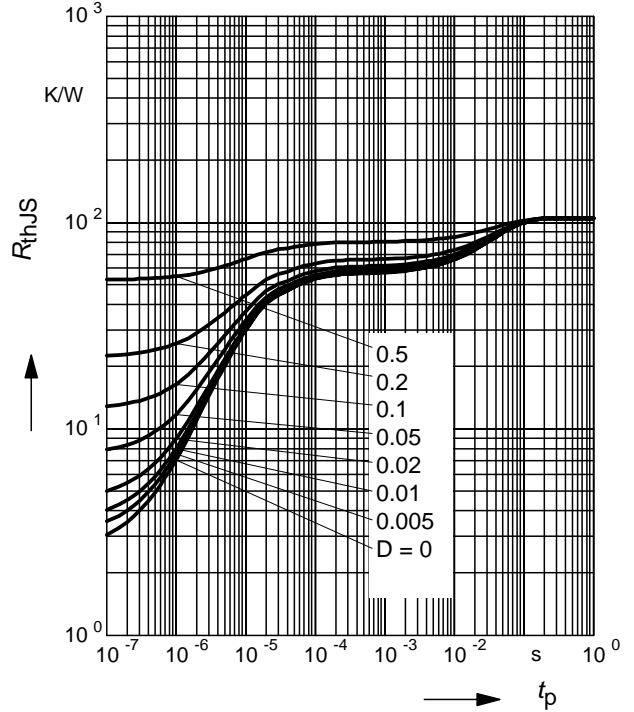

**Permissible Pulse Load**

$P_{totmax}/P_{totDC} = f(t_p)$

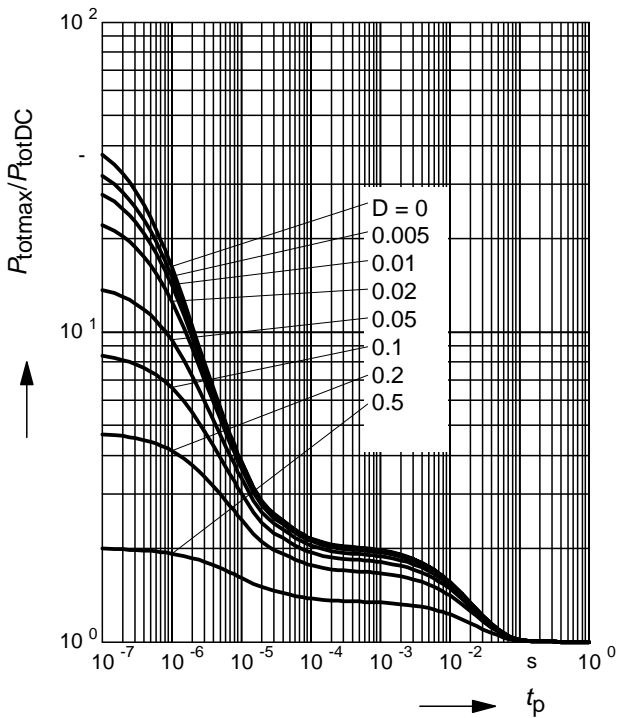

Package Outline

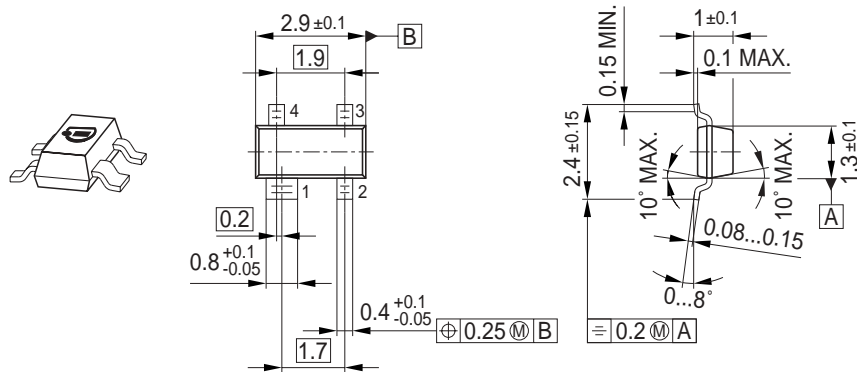

Foot Print

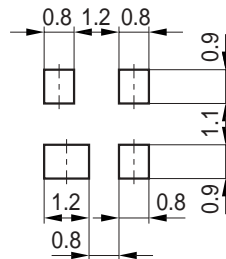

Marking Layout (Example)

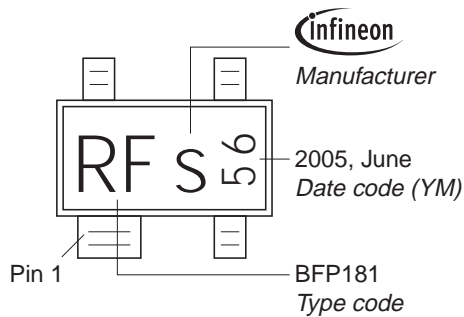

Standard Packing

Reel  $\varnothing 180 \text{ mm} = 3.000 \text{ Pieces/Reel}$   
 Reel  $\varnothing 330 \text{ mm} = 10.000 \text{ Pieces/Reel}$



Edition 2006-02-01

Published by

Infineon Technologies AG

81726 München, Germany

© Infineon Technologies AG 2007.

All Rights Reserved.

### **Attention please!**

The information given in this dokument shall in no event be regarded as a guarantee of conditions or characteristics ("Beschaffenheitsgarantie"). With respect to any examples or hints given herein, any typical values stated herein and/or any information regarding the application of the device, Infineon Technologies hereby disclaims any and all warranties and liabilities of any kind, including without limitation warranties of non-infringement of intellectual property rights of any third party.

### **Information**

For further information on technology, delivery terms and conditions and prices please contact your nearest Infineon Technologies Office ([www.infineon.com](http://www.infineon.com)).

### **Warnings**

Due to technical requirements components may contain dangerous substances. For information on the types in question please contact your nearest Infineon Technologies Office.

Infineon Technologies Components may only be used in life-support devices or systems with the express written approval of Infineon Technologies, if a failure of such components can reasonably be expected to cause the failure of that life-support device or system, or to affect the safety or effectiveness of that device or system.

Life support devices or systems are intended to be implanted in the human body, or to support and/or maintain and sustain and/or protect human life. If they fail, it is reasonable to assume that the health of the user or other persons may be endangered.

# Mouser Electronics

Authorized Distributor

Click to View Pricing, Inventory, Delivery & Lifecycle Information:

[Infineon:](#)

[BFP 196 E6327](#) [BFP 196R E6327](#)