

OLGA-W

~40° wide beam with flange

SPECIFICATION:

Dimensions	Ø 30.0
Height	18.5 mm
Fastening	glue
ROHS compliant	yes ⓘ



MATERIALS:

Component	Type	Material	Colour	Finish	Length (mm)
OLGA-W	Single lens	PMMA	clear		

ORDERING INFORMATION:

Component	Qty in box	MOQ	MPQ	Box weight (kg)
C16125_OLGA-W » Box size: 476 x 273 x 292 mm	792	132	66	7.6

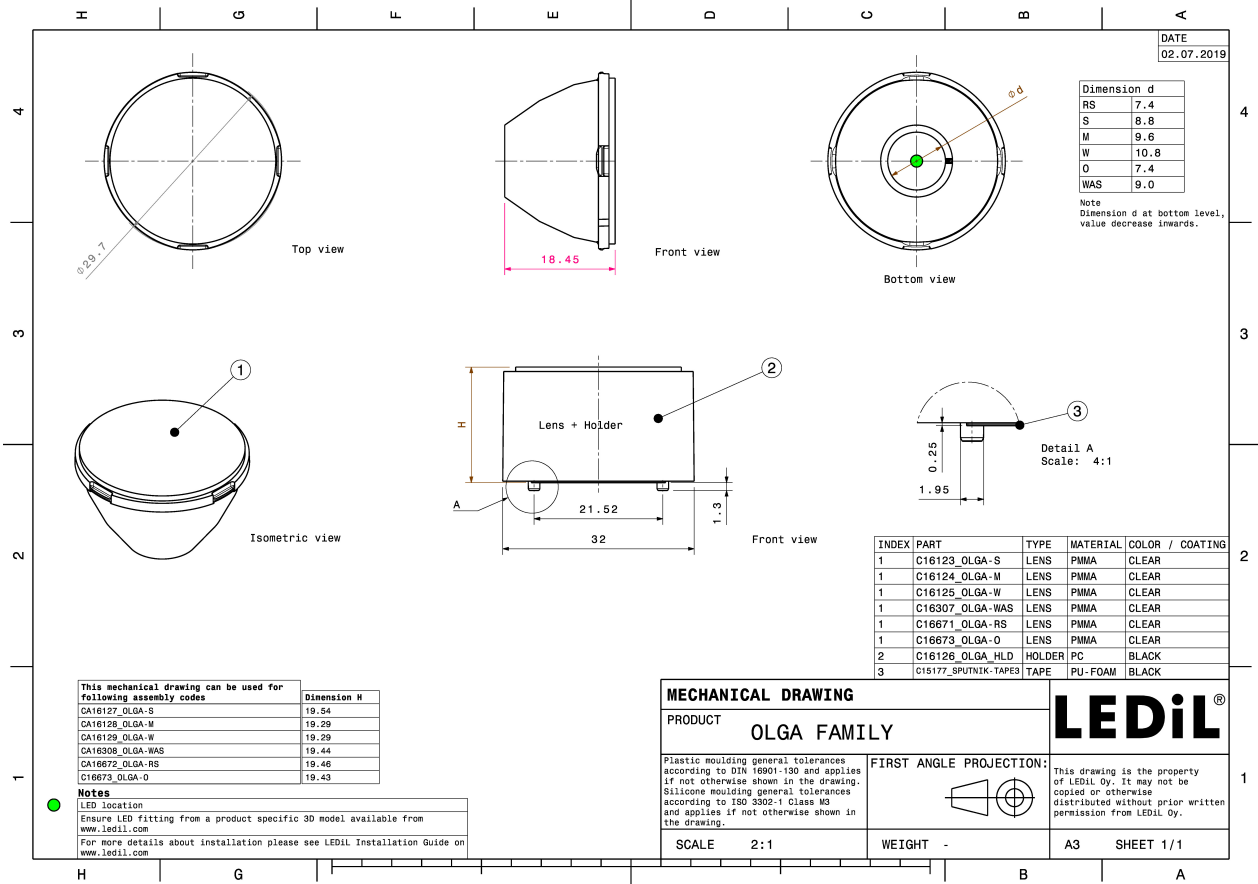

See also our general installation guide: www.ledil.com/installation_guide

OPTICAL RESULTS (MEASURED):

bridgelux

LED V4 HD Gen 7
 FWHM / FWTM 31.0° / 55.0°
 Efficiency 87 %
 Peak intensity 2.5 cd/lm
 LEDs/each optic 1
 Light colour/type White
 Required components:

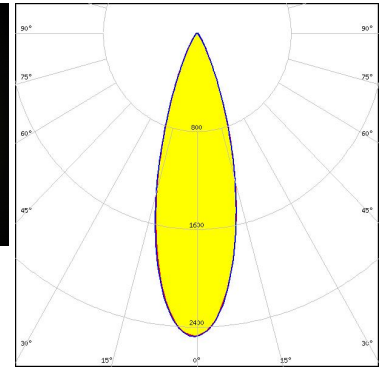
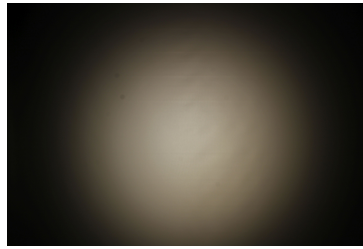

Light distribution files

bridgelux

LED Vesta TW 6mm DP
 FWHM / FWTM 36.0° / 64.0°
 Efficiency 85 %
 Peak intensity 1.8 cd/lm
 LEDs/each optic 1
 Light colour/type White
 Required components:

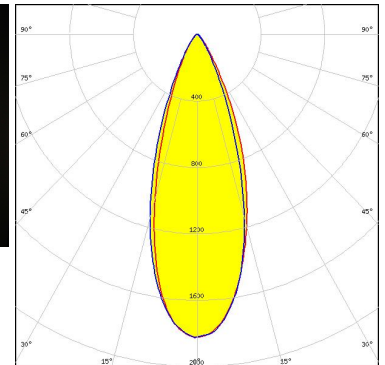
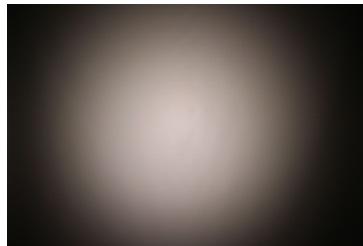

Light distribution files

CITIZEN

LED CLU7A2/7A3
 FWHM / FWTM 28.0° / 54.0°
 Efficiency 88 %
 Peak intensity 2.7 cd/lm
 LEDs/each optic 1
 Light colour/type White
 Required components:

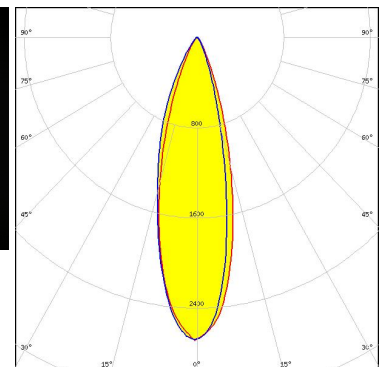
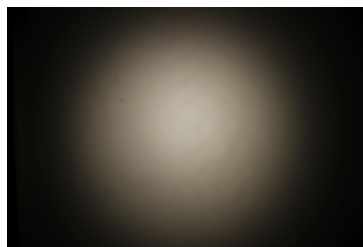

Light distribution files

OPTICAL RESULTS (MEASURED):

CITIZEN

LED CLU7B2
FWHM / FWTM 28.0° / 52.0°
Efficiency 82 %
Peak intensity 2.7 cd/lm
LEDs/each optic 1
Light colour/type White
Required components:

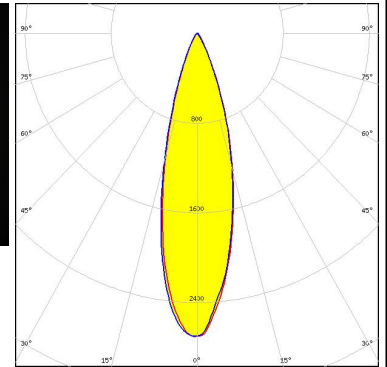

Light distribution files

CITIZEN

LED CLU7L3
FWHM / FWTM 27.0° / 51.0°
Efficiency 86 %
Peak intensity 3.1 cd/lm
LEDs/each optic 1
Light colour/type White
Required components:

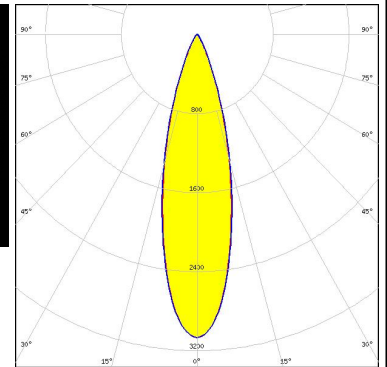

Light distribution files

CITIZEN

LED CLU7R3
FWHM / FWTM 30.0° / 55.0°
Efficiency 82 %
Peak intensity 2.5 cd/lm
LEDs/each optic 1
Light colour/type White
Required components:

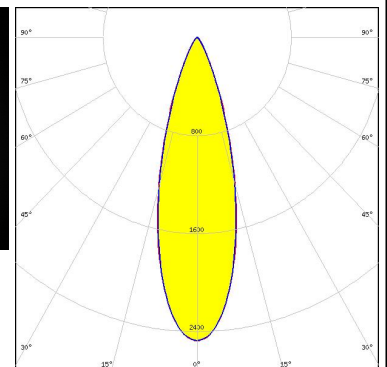
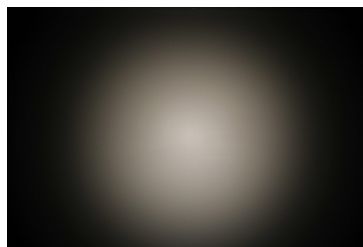

Light distribution files

OPTICAL RESULTS (MEASURED):

CITIZEN

LED CLU7S3
 FWHM / FWTM 29.0° / 52.0°
 Efficiency 91 %
 Peak intensity 3 cd/lm
 LEDs/each optic 1
 Light colour/type White
 Required components:

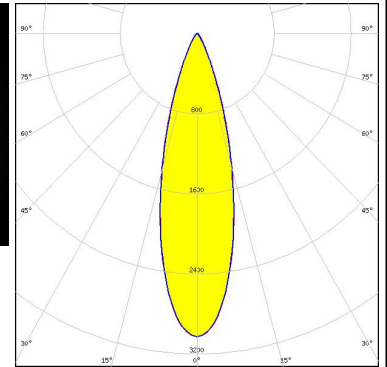
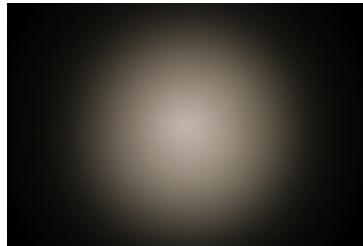

Light distribution files

OSRAM

Opto Semiconductors

LED OSCONIQ P 3737 (3W version)
 FWHM / FWTM 38.0° / 59.0°
 Efficiency 86 %
 Peak intensity 2 cd/lm
 LEDs/each optic 1
 Light colour/type White
 Required components:

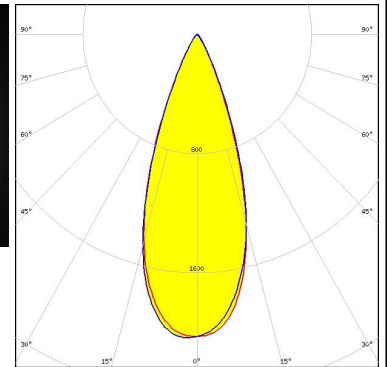
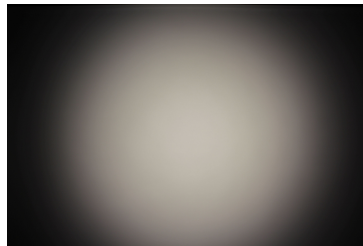

Light distribution files

OPTICAL RESULTS (SIMULATED):



LED V6 HD Gen 7
FWHM / FWTM 43.0° / 62.0°
Efficiency 95 %
Peak intensity 2 cd/lm
LEDs/each optic 1
Light colour/type White
Required components:

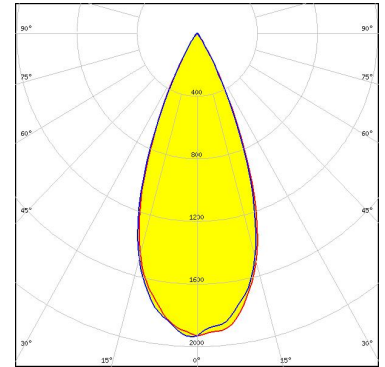

Light distribution files



LED CMA1303
FWHM / FWTM 46.0° / 62.0°
Efficiency 95 %
Peak intensity 1.8 cd/lm
LEDs/each optic 1
Light colour/type White
Required components:

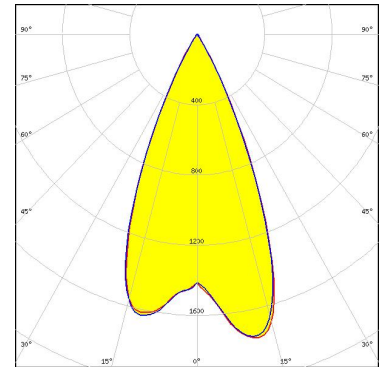

Light distribution files



LED CXA/B 13xx
FWHM / FWTM 38.0° / 58.0°
Efficiency 96 %
Peak intensity 2.4 cd/lm
LEDs/each optic 1
Light colour/type White
Required components:

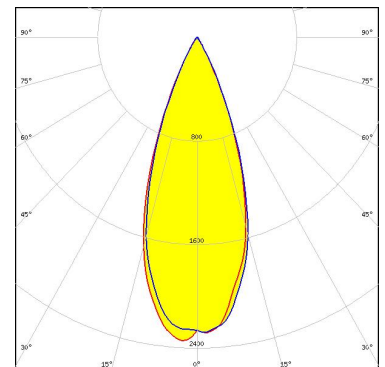

Light distribution files

OPTICAL RESULTS (SIMULATED):



LED CXM-3
 FWHM / FWTM 34.0° / 52.0°
 Efficiency 96 %
 Peak intensity 2.9 cd/lm
 LEDs/each optic 1
 Light colour/type White
 Required components:

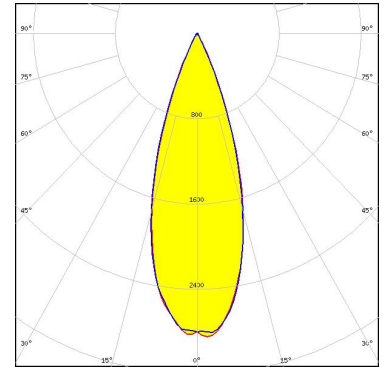

Light distribution files



LED CXM-4
 FWHM / FWTM 35.0° / 54.0°
 Efficiency 96 %
 Peak intensity 2.7 cd/lm
 LEDs/each optic 1
 Light colour/type White
 Required components:

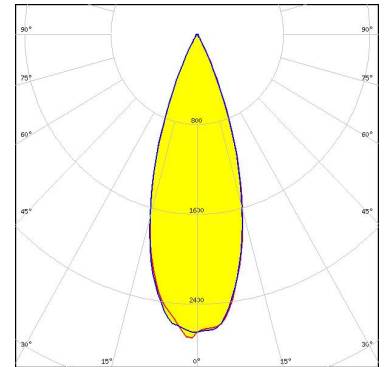

Light distribution files



LED MJT COB LES 6
 FWHM / FWTM 35.0° / 57.0°
 Efficiency 94 %
 Peak intensity 2.6 cd/lm
 LEDs/each optic 1
 Light colour/type White
 Required components:

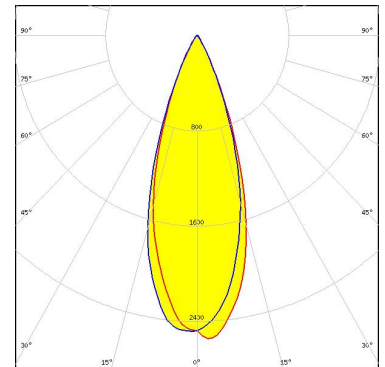

Light distribution files

OPTICAL RESULTS (SIMULATED):

XICATO

LED	XOB 6 mm
FWHM / FWTM	46.0° / 64.0°
Efficiency	91 %
Peak intensity	1.6 cd/lm
LEDs/each optic	1
Light colour/type	White
Required components:	

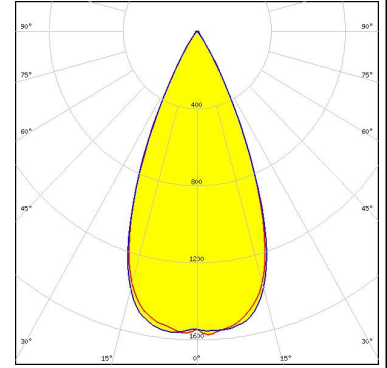

Light distribution files

XICATO

LED	XOB 9.8 mm
FWHM / FWTM	44.0° / 70.0°
Efficiency	95 %
Peak intensity	1.7 cd/lm
LEDs/each optic	1
Light colour/type	White
Required components:	

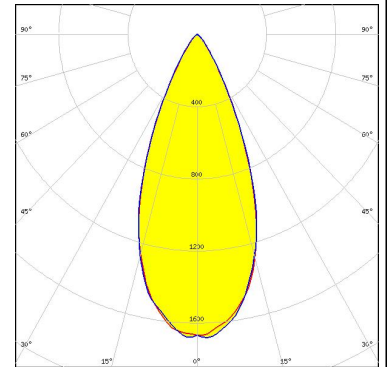

Light distribution files

GENERAL INFORMATION:

NOTE: The typical beam angle will be changed by different color, chip size and chip position tolerance. The typical total beam angle is the full angle measured where the luminous intensity is half of the peak value.

Due to use of high power COB's with this product, special attention to proper thermal design is highly recommended. LEDiL has no liability for direct, indirect or consecutive damages arising from the LEDiL products being used outside of the recommended temperature range.

MATERIALS:

As part of our continuous research and improvement processes, and to ensure the best possible quality and availability of our products, LEDiL reserves the right to change material grades without notice.

PRODUCT DATA USER AGREEMENT AND DISCLAIMER:

The measured data in the provided downloadable LEDiL Product Datasheets and Mechanical 2D-Drawings is rounded and provided as reference for planning. LEDiL Oy's optical specifications have been verified by conducting performance testing of the products in accordance with the company's quality system. The reported data are averaged results of multiple measurements with typical variation. LEDiL Oy reserves the right to without prior notification make changes and improvements to its products.

LEDiL Oy assumes neither warranty, nor guarantee nor any other liability of any kind for the contents and correctness of the provided data. The provided data has been generated with highest diligence but the provided data may in reality not represent the complete possible variation range of all intrinsic parameters. Therefore, in certain cases a deviation from the provided data could occur.

LEDiL Oy reserves the right to undertake technical changes of its products without further notification which could lead to changes in the provided data. LEDiL Oy assumes no liability of any kind for the possible deviation from any provided data or any other damage resulting from the usage of the provided data.

The user agrees to this disclaimer and user agreement with the download or usage of the provided files.

LEDiL Oy

Joensuunkatu 7
FI-24240 SALO
Finland

LEDiL Inc.

228 West Page Street
Suite D
Sycamore IL 60178
USA

Ledil Optics Technology (Shenzhen) Co., Ltd.

405 , Block B
Casic Motor Building
Shenzhen 518057
P.R.CHINA

Local sales and technical support

[www.ledil.com/
where_to_buy](http://www.ledil.com/where_to_buy)

Shipping locations

Poznan, Poland
Hong Kong, China

Distribution Partners

[www.ledil.com/
where_to_buy](http://www.ledil.com/where_to_buy)