

**IRFB4410PbF**  
**IRFS4410PbF**  
**IRFSL4410PbF**

**Applications**

- High Efficiency Synchronous Rectification in SMPS
- Uninterruptible Power Supply
- High Speed Power Switching
- Hard Switched and High Frequency Circuits

HEXFET® Power MOSFET

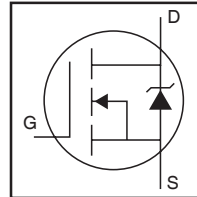

<b>V<sub>DSS</sub></b>		<b>100V</b>
<b>R<sub>DS(on)</sub></b>	<b>typ.</b>	<b>8.0mΩ</b>
	<b>max.</b>	<b>10mΩ</b>
<b>I<sub>D</sub></b>		<b>88A</b>

**Benefits**

- Improved Gate, Avalanche and Dynamic dV/dt Ruggedness
- Fully Characterized Capacitance and Avalanche SOA
- Enhanced body diode dV/dt and dI/dt Capability
- Lead-Free



**Absolute Maximum Ratings**

Symbol	Parameter	Max.	Units
I <sub>D</sub> @ T <sub>C</sub> = 25°C	Continuous Drain Current, V <sub>GS</sub> @ 10V	88①②	A
I <sub>D</sub> @ T <sub>C</sub> = 100°C	Continuous Drain Current, V <sub>GS</sub> @ 10V	63①②	
I <sub>DM</sub>	Pulsed Drain Current ②	380	
P <sub>D</sub> @ T <sub>C</sub> = 25°C	Maximum Power Dissipation	200③	W
	Linear Derating Factor	1.3③	W/°C
V <sub>GS</sub>	Gate-to-Source Voltage	± 20	V
dv/dt	Peak Diode Recovery ④	19	V/ns
T <sub>J</sub>	Operating Junction and Storage Temperature Range	-55 to + 175	°C
T <sub>STG</sub>			
	Soldering Temperature, for 10 seconds (1.6mm from case)	300	
	Mounting torque, 6-32 or M3 screw	10lb·in (1.1N·m)	

**Avalanche Characteristics**

E <sub>AS</sub> (Thermally limited)	Single Pulse Avalanche Energy ③	220	mJ
I <sub>AR</sub>	Avalanche Current ①	See Fig. 14, 15, 16a, 16b	A
E <sub>AR</sub>	Repetitive Avalanche Energy ⑤		mJ

**Thermal Resistance**

Symbol	Parameter	Typ.	Max.	Units
R <sub>θJC</sub>	Junction-to-Case ⑥	—	0.61⑦	°C/W
R <sub>θCS</sub>	Case-to-Sink, Flat Greased Surface , TO-220	0.50	—	
R <sub>θJA</sub>	Junction-to-Ambient, TO-220 ⑧	—	62	
R <sub>θJA</sub>	Junction-to-Ambient (PCB Mount) , D²Pak ⑧ ⑨	—	40	

**Static @ T<sub>J</sub> = 25°C (unless otherwise specified)**

Symbol	Parameter	Min.	Typ.	Max.	Units	Conditions
V <sub>(BR)DSS</sub>	Drain-to-Source Breakdown Voltage	100	—	—	V	V <sub>GS</sub> = 0V, I <sub>D</sub> = 250μA
ΔV <sub>(BR)DSS</sub> /ΔT <sub>J</sub>	Breakdown Voltage Temp. Coefficient	—	0.094	—	V/°C	Reference to 25°C, I <sub>D</sub> = 1mA②
R <sub>DS(on)</sub>	Static Drain-to-Source On-Resistance	—	8.0	10	mΩ	V <sub>GS</sub> = 10V, I <sub>D</sub> = 58A ⑤
V <sub>GS(th)</sub>	Gate Threshold Voltage	2.0	—	4.0	V	V <sub>DS</sub> = V <sub>GS</sub> , I <sub>D</sub> = 150μA
I <sub>DSS</sub>	Drain-to-Source Leakage Current	—	—	20	μA	V <sub>DS</sub> = 100V, V <sub>GS</sub> = 0V
		—	—	250		V <sub>DS</sub> = 100V, V <sub>GS</sub> = 0V, T <sub>J</sub> = 125°C
I <sub>GSS</sub>	Gate-to-Source Forward Leakage	—	—	200	nA	V <sub>GS</sub> = 20V
	Gate-to-Source Reverse Leakage	—	—	-200		V <sub>GS</sub> = -20V
R <sub>G</sub>	Gate Input Resistance	—	1.5	—	Ω	f = 1MHz, open drain

**Dynamic @ T<sub>J</sub> = 25°C (unless otherwise specified)**

Symbol	Parameter	Min.	Typ.	Max.	Units	Conditions
gfs	Forward Transconductance	120	—	—	S	V <sub>DS</sub> = 50V, I <sub>D</sub> = 58A
Q <sub>g</sub>	Total Gate Charge	—	120	180	nC	I <sub>D</sub> = 58A
Q <sub>gs</sub>	Gate-to-Source Charge	—	31	—		V <sub>DS</sub> = 80V
Q <sub>gd</sub>	Gate-to-Drain ("Miller") Charge	—	44	—		V <sub>GS</sub> = 10V ⑤
t <sub>d(on)</sub>	Turn-On Delay Time	—	24	—	ns	V <sub>DD</sub> = 65V
t <sub>r</sub>	Rise Time	—	80	—		I <sub>D</sub> = 58A
t <sub>d(off)</sub>	Turn-Off Delay Time	—	55	—		R <sub>G</sub> = 4.1Ω
t <sub>f</sub>	Fall Time	—	50	—		V <sub>GS</sub> = 10V ⑤
C <sub>iss</sub>	Input Capacitance	—	5150	—	pF	V <sub>GS</sub> = 0V
C <sub>oss</sub>	Output Capacitance	—	360	—		V <sub>DS</sub> = 50V
C <sub>rss</sub>	Reverse Transfer Capacitance	—	190	—		f = 1.0MHz
C <sub>oss eff. (ER)</sub>	Effective Output Capacitance (Energy Related)	—	420	—		V <sub>GS</sub> = 0V, V <sub>DS</sub> = 0V to 80V ⑦, See Fig.11
C <sub>oss eff. (TR)</sub>	Effective Output Capacitance (Time Related)⑧	—	500	—		V <sub>GS</sub> = 0V, V <sub>DS</sub> = 0V to 80V ⑧, See Fig. 5

**Diode Characteristics**

Symbol	Parameter	Min.	Typ.	Max.	Units	Conditions
I <sub>S</sub>	Continuous Source Current (Body Diode)	—	—	88①	A	MOSFET symbol showing the integral reverse p-n junction diode.
I <sub>SM</sub>	Pulsed Source Current (Body Diode) ②	—	—	380	A	
V <sub>SD</sub>	Diode Forward Voltage	—	—	1.3	V	T <sub>J</sub> = 25°C, I <sub>S</sub> = 58A, V <sub>GS</sub> = 0V ③
t <sub>rr</sub>	Reverse Recovery Time	—	38	56	ns	T <sub>J</sub> = 25°C V <sub>R</sub> = 85V, T <sub>J</sub> = 125°C I <sub>F</sub> = 58A
Q <sub>rr</sub>	Reverse Recovery Charge	—	61	92	nC	T <sub>J</sub> = 25°C di/dt = 100A/μs ⑤ T <sub>J</sub> = 125°C
I <sub>RRM</sub>	Reverse Recovery Current	—	2.8	—	A	T <sub>J</sub> = 25°C
t <sub>on</sub>	Forward Turn-On Time	Intrinsic turn-on time is negligible (turn-on is dominated by LS+LD)				

**Notes:**

- ① Calculated continuous current based on maximum allowable junction temperature. Package limitation current is 75A.
- ② Repetitive rating; pulse width limited by max. junction temperature.
- ③ Limited by T<sub>Jmax</sub>, starting T<sub>J</sub> = 25°C, L = 0.14mH R<sub>G</sub> = 25Ω, I<sub>AS</sub> = 58A, V<sub>GS</sub> = 10V. Part not recommended for use above this value.
- ④ I<sub>SD</sub> ≤ 58A, di/dt ≤ 650A/μs, V<sub>DD</sub> ≤ V<sub>(BR)DSS</sub>, T<sub>J</sub> ≤ 175°C.
- ⑤ Pulse width ≤ 400μs; duty cycle ≤ 2%.
- ⑥ C<sub>oss eff. (TR)</sub> is a fixed capacitance that gives the same charging time as C<sub>oss</sub> while V<sub>DS</sub> is rising from 0 to 80% V<sub>DSS</sub>.
- ⑦ C<sub>oss eff. (ER)</sub> is a fixed capacitance that gives the same energy as C<sub>oss</sub> while V<sub>DS</sub> is rising from 0 to 80% V<sub>DSS</sub>.
- ⑧ When mounted on 1" square PCB (FR-4 or G-10 Material). For recommended footprint and soldering techniques refer to application note #AN-994.
- ⑨ R<sub>θ</sub> is measured at T<sub>J</sub> approximately 90°C.
- ⑩ R<sub>θJC</sub> (end of life) for D<sup>2</sup>Pak and TO-262 = 0.75°C/W. Note: This is the maximum measured value after 1000 temperature cycles from -55 to 150°C and is accounted for by the physical wearout of the die attach medium.

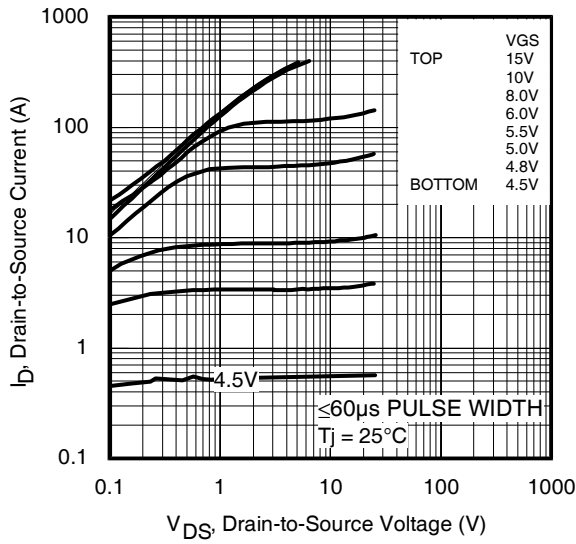

Fig 1. Typical Output Characteristics

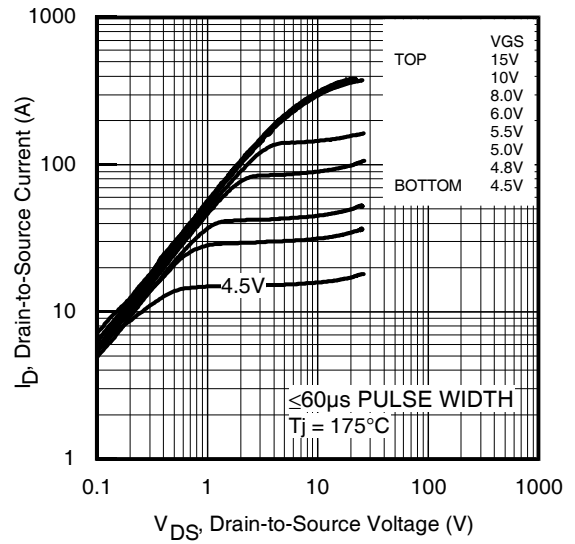

Fig 2. Typical Output Characteristics

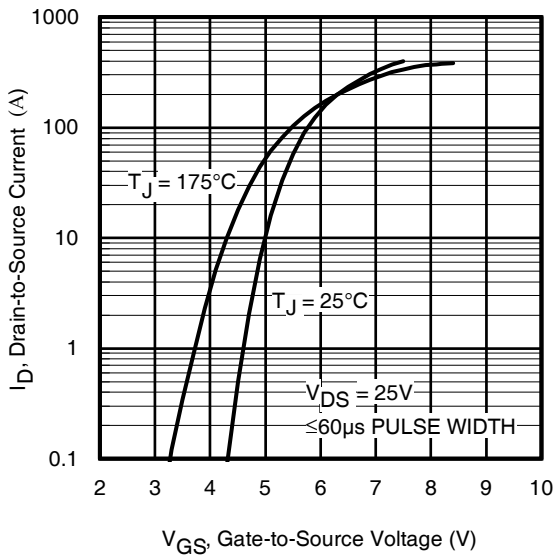

Fig 3. Typical Transfer Characteristics

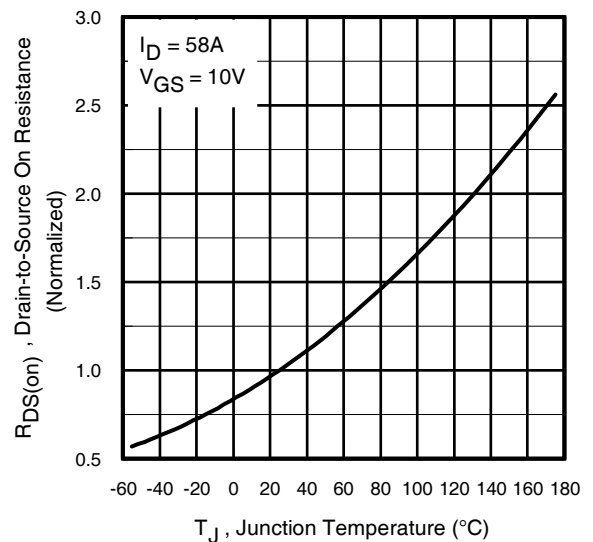

Fig 4. Normalized On-Resistance vs. Temperature

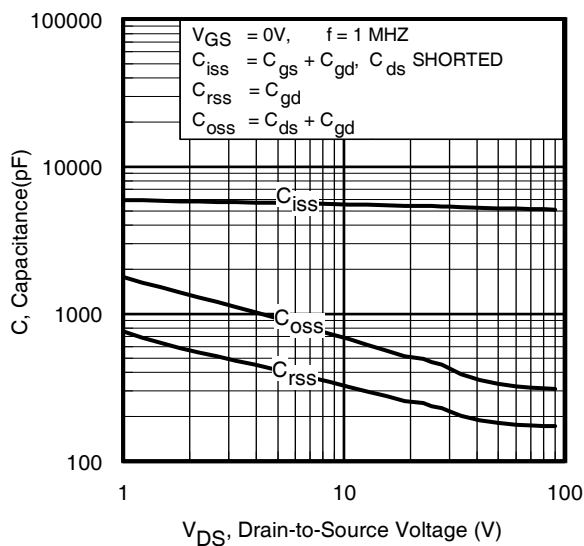

Fig 5. Typical Capacitance vs. Drain-to-Source Voltage

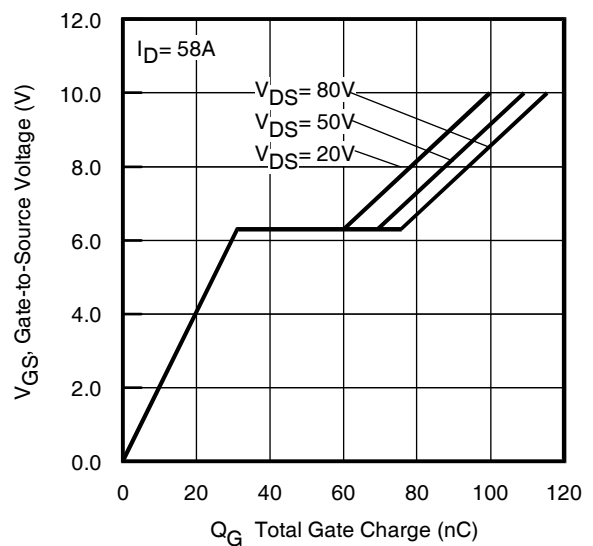

Fig 6. Typical Gate Charge vs. Gate-to-Source Voltage

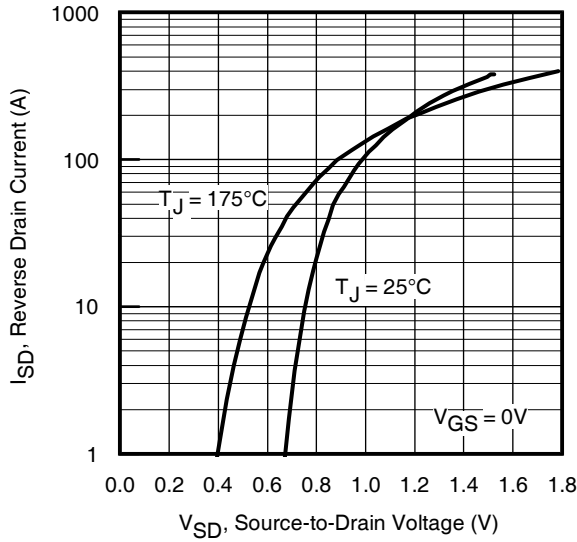

Fig 7. Typical Source-Drain Diode Forward Voltage

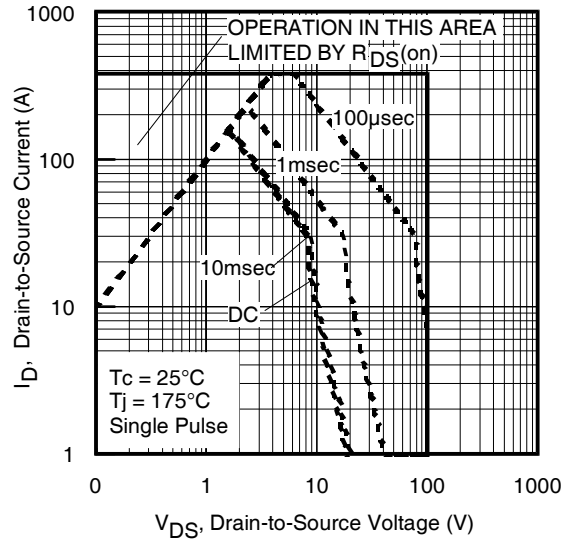

Fig 8. Maximum Safe Operating Area

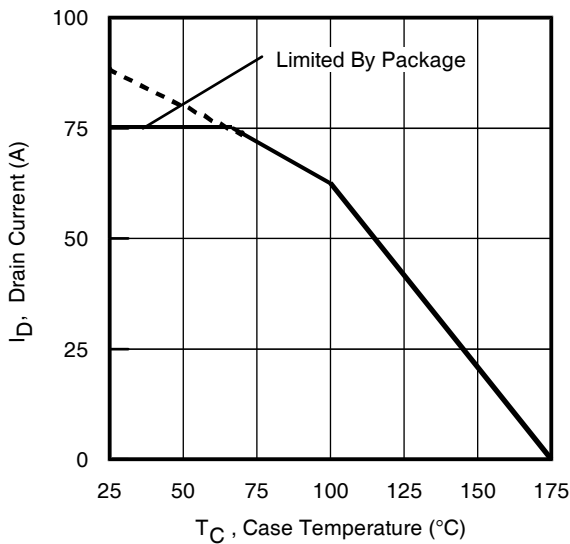

Fig 9. Maximum Drain Current vs. Case Temperature

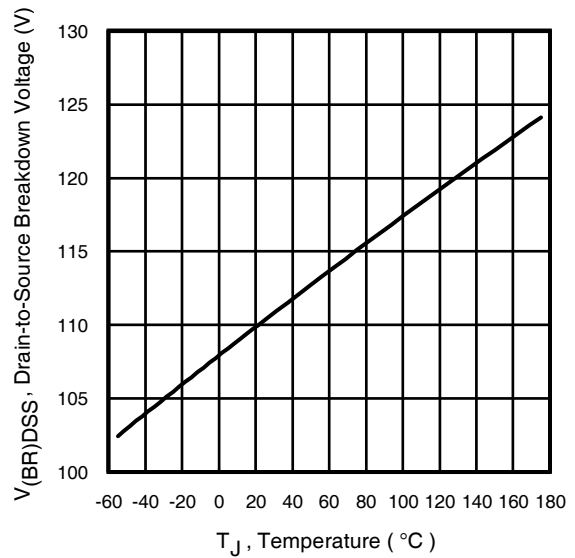

Fig 10. Drain-to-Source Breakdown Voltage

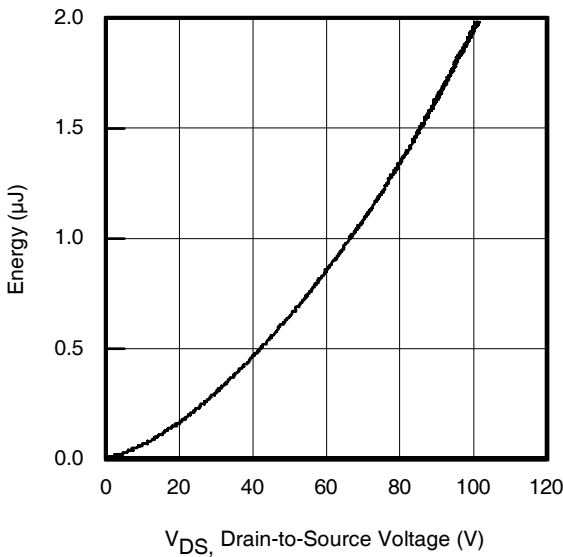

Fig 11. Typical  $C_{OSS}$  Stored Energy

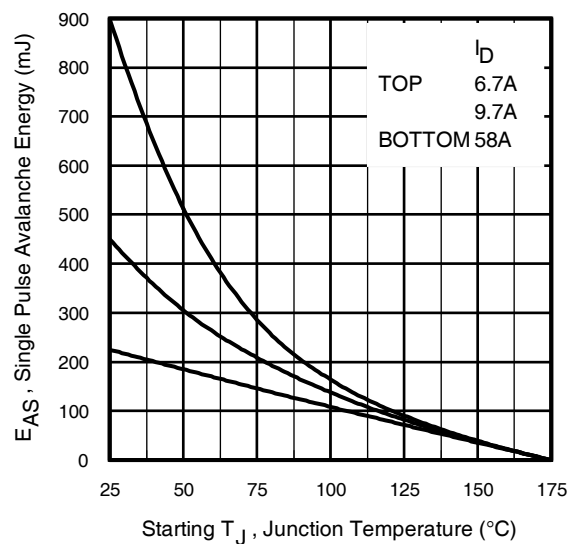

Fig 12. Maximum Avalanche Energy vs. Drain Current

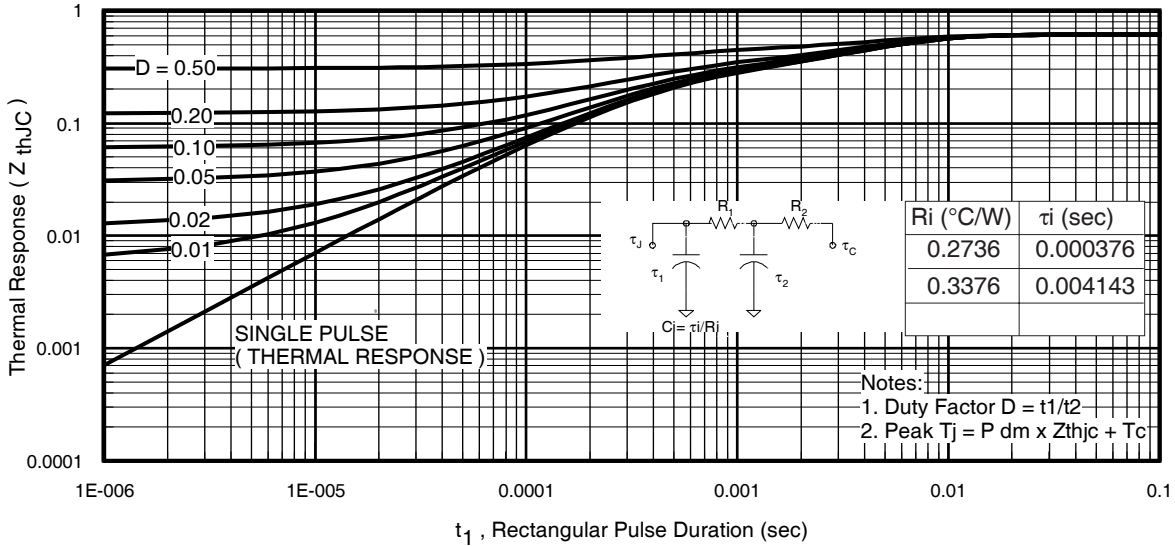

Fig 13. Maximum Effective Transient Thermal Impedance, Junction-to-Case

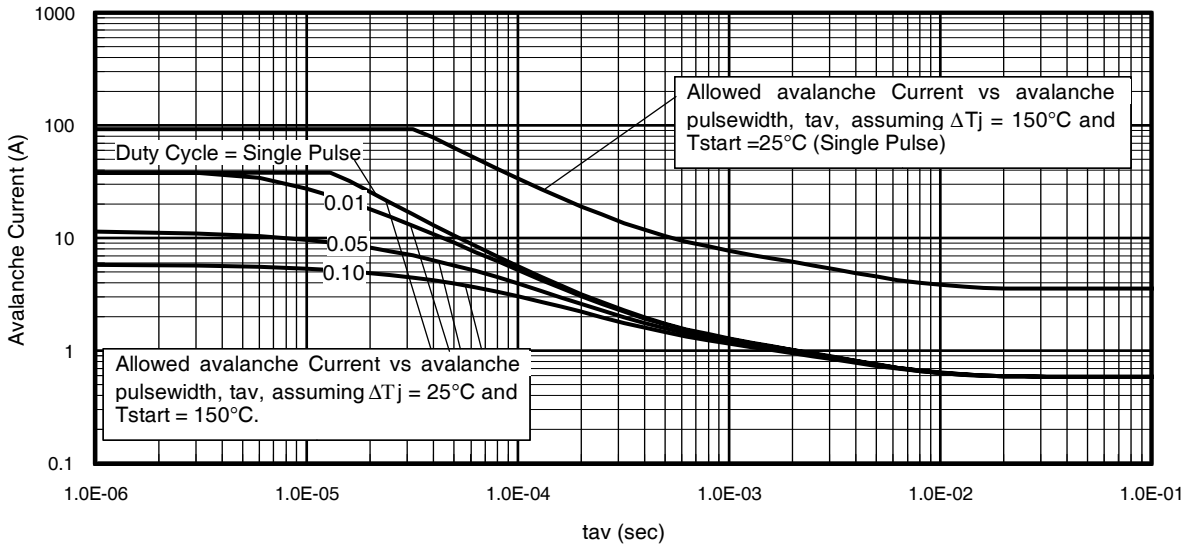

Fig 14. Typical Avalanche Current vs. Pulsewidth

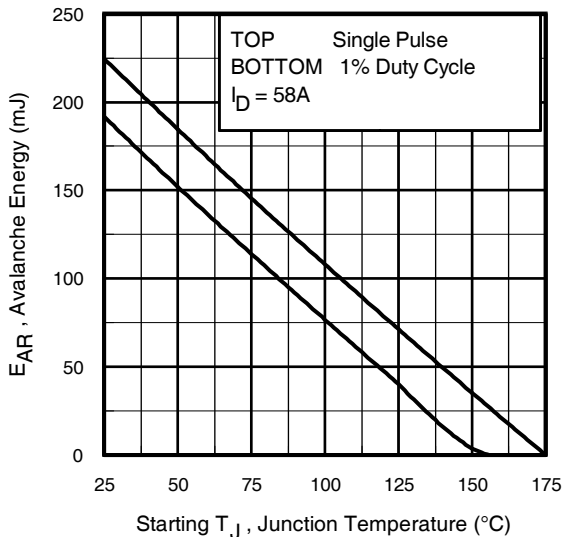

Fig 15. Maximum Avalanche Energy vs. Temperature

**Notes on Repetitive Avalanche Curves , Figures 14, 15:**  
(For further info, see AN-1005 at [www.irf.com](http://www.irf.com))

1. Avalanche failures assumption:  
Purely a thermal phenomenon and failure occurs at a temperature far in excess of  $T_{jmax}$ . This is validated for every part type.
2. Safe operation in Avalanche is allowed as long as neither  $T_{jmax}$  nor  $I_{av(max)}$  is exceeded.
3. Equation below based on circuit and waveforms shown in Figures 16a, 16b.
4.  $P_{D(ave)}$  = Average power dissipation per single avalanche pulse.
5.  $BV$  = Rated breakdown voltage (1.3 factor accounts for voltage increase during avalanche).
6.  $I_{av}$  = Allowable avalanche current.
7.  $\Delta T$  = Allowable rise in junction temperature, not to exceed  $T_{jmax}$  (assumed as 25°C in Figure 14, 15).  
 $t_{av}$  = Average time in avalanche.  
 $D$  = Duty cycle in avalanche =  $t_{av} \cdot f$   
 $Z_{thJC}(D, t_{av})$  = Transient thermal resistance, see Figures 13)

$$P_{D(ave)} = 1/2 (1.3 \cdot BV \cdot I_{av}) = \Delta T / Z_{thJC}$$

$$I_{av} = 2\Delta T / [1.3 \cdot BV \cdot Z_{th}]$$

$$E_{AS(AR)} = P_{D(ave)} \cdot t_{av}$$

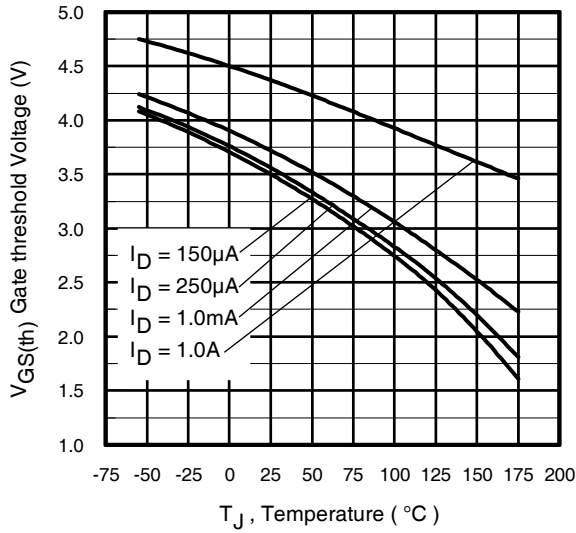

Fig 16. Threshold Voltage vs. Temperature

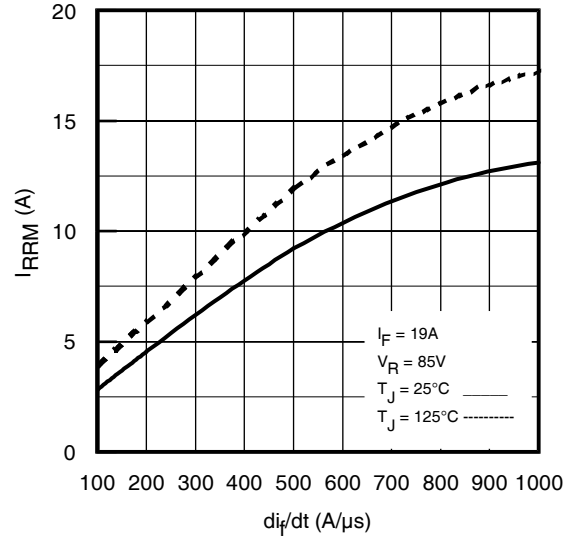

Fig. 17 - Typical Recovery Current vs.  $di_t/dt$

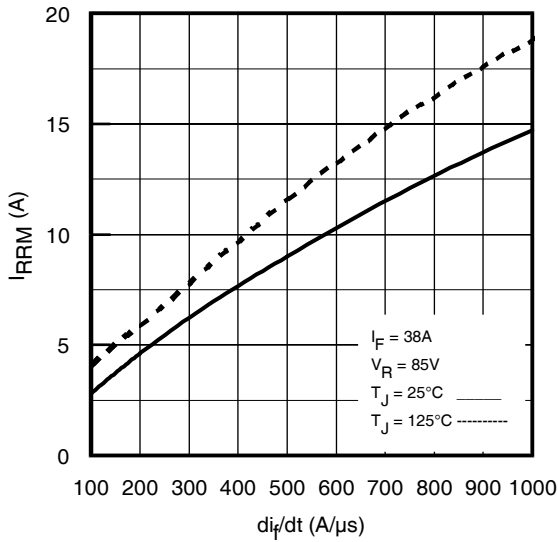

Fig. 18 - Typical Recovery Current vs.  $di_t/dt$

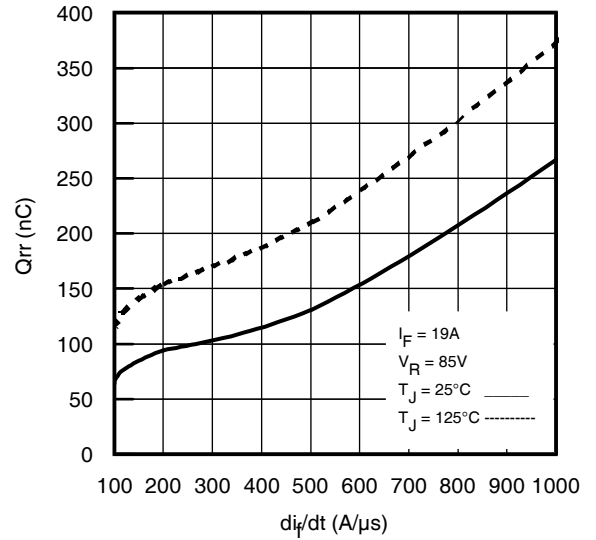

Fig. 19 - Typical Stored Charge vs.  $di_t/dt$

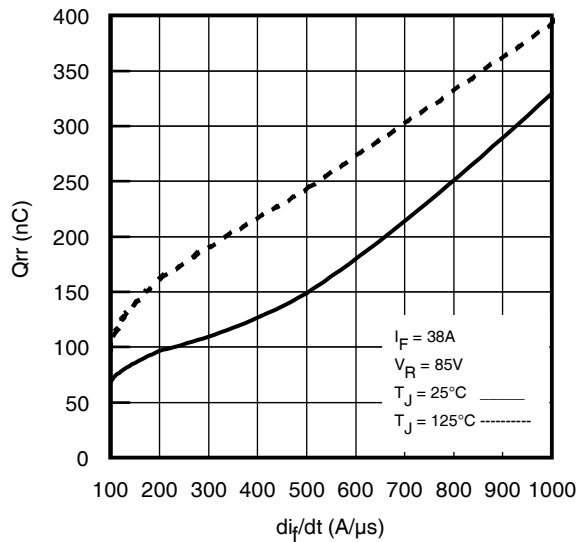
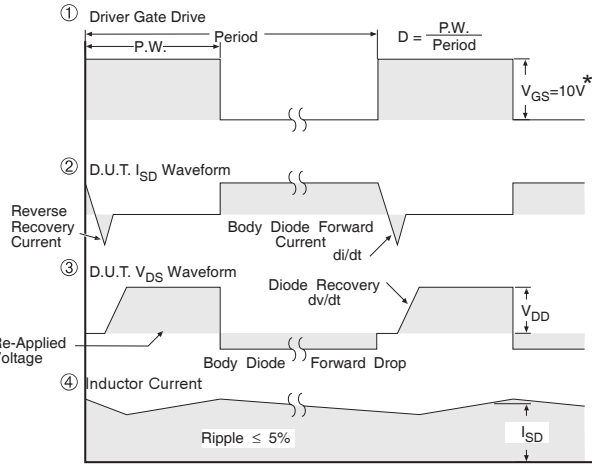

Fig. 20 - Typical Stored Charge vs.  $di_t/dt$



\*  $V_{GS} = 5V$  for Logic Level Devices

**Fig 20. Peak Diode Recovery dv/dt Test Circuit for N-Channel HEXFET® Power MOSFETs**



**Fig 21a. Unclamped Inductive Test Circuit**



**Fig 21b. Unclamped Inductive Waveforms**



**Fig 22a. Switching Time Test Circuit**



**Fig 22b. Switching Time Waveforms**



**Fig 23a. Gate Charge Test Circuit**



**Fig 23b. Gate Charge Waveform**

## TO-220AB Package Outline

Dimensions are shown in millimeters (inches)

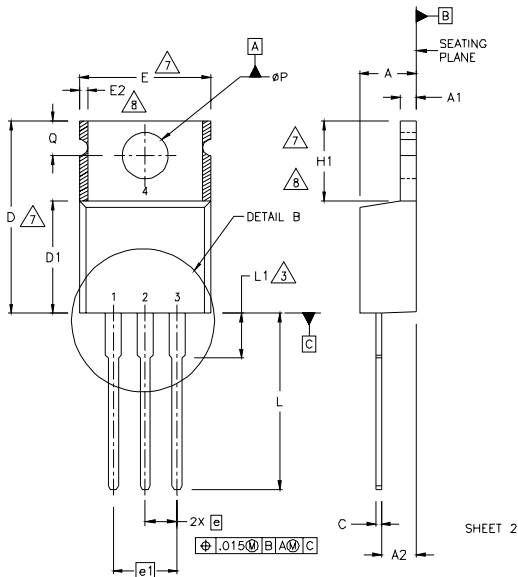

- NOTES:
- 1 DIMENSIONING AND TOLERANCING PER ASME Y14.5 M- 1994.
  - 2 DIMENSIONS ARE SHOWN IN INCHES (MILLIMETERS).
  - 3 LEAD DIMENSION AND FINISH UNCONTROLLED IN L1.
  - 4 DIMENSION D & E DO NOT INCLUDE MOLD FLASH. MOLD FLASH SHALL NOT EXCEED .005" (0.127) PER SIDE. THESE DIMENSIONS ARE MEASURED AT THE OUTERMOST EXTREMES OF THE PLASTIC BODY.
  - 5 DIMENSION b1 & c1 APPLY TO BASE METAL ONLY.
  - 6 CONTROLLING DIMENSION : INCHES.
  - 7 THERMAL PAD CONTOUR OPTIONAL WITHIN DIMENSIONS E,H1,D2 & E1
  - 8 DIMENSION E2 X H1 DEFINE A ZONE WHERE STAMPING AND SINGULATION IRREGULARITIES ARE ALLOWED.

**LEAD ASSIGNMENTS**

**HEXFET**

- 1.- GATE
- 2.- DRAIN
- 3.- SOURCE

**IGBTs, CoPACK**

- 1.- GATE
- 2.- COLLECTOR
- 3.- EMITTER

**DIODES**

- 1.- ANODE/OPEN
- 2.- CATHODE
- 3.- ANODE

SYMBOL	DIMENSIONS				NOTES
	MILLIMETERS		INCHES		
	MIN.	MAX.	MIN.	MAX.	
A	3.56	4.82	.140	.190	
A1	0.51	1.40	.020	.055	
A2	2.04	2.92	.080	.115	
b	0.38	1.01	.015	.040	
b1	0.38	0.96	.015	.038	5
b2	1.15	1.77	.045	.070	
b3	1.15	1.73	.045	.068	
c	0.36	0.61	.014	.024	
c1	0.36	0.56	.014	.022	5
D	14.22	16.51	.560	.650	4
D1	8.38	9.02	.330	.355	
D2	12.19	12.88	.480	.507	7
E	9.66	10.66	.380	.420	4,7
E1	8.38	8.89	.330	.350	7
e	2.54 BSC		.100 BSC		
e1	5.08		.200 BSC		
H1	5.85	6.55	.230	.270	7,8
L	12.70	14.73	.500	.580	
L1	-	6.35	-	.250	3
øP	3.54	4.08	.139	.161	
Q	2.54	3.42	.100	.135	
ø	90°-93°		90°-93°		

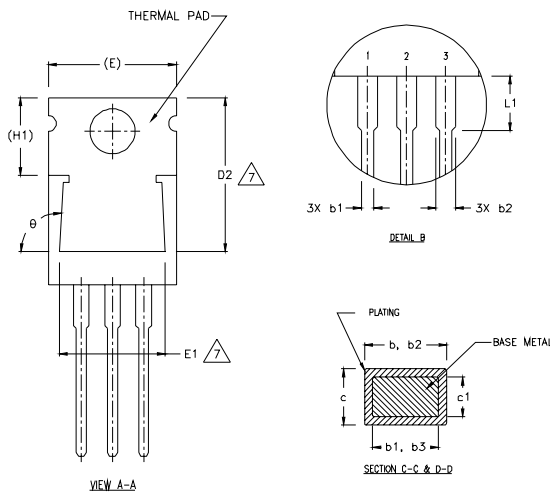

## TO-220AB Part Marking Information

EXAMPLE: THIS IS AN IRF1010  
 LOT CODE 1789  
 ASSEMBLED ON WW 19, 2000  
 IN THE ASSEMBLY LINE "C"

Note: "P" in assembly line position indicates "Lead - Free"

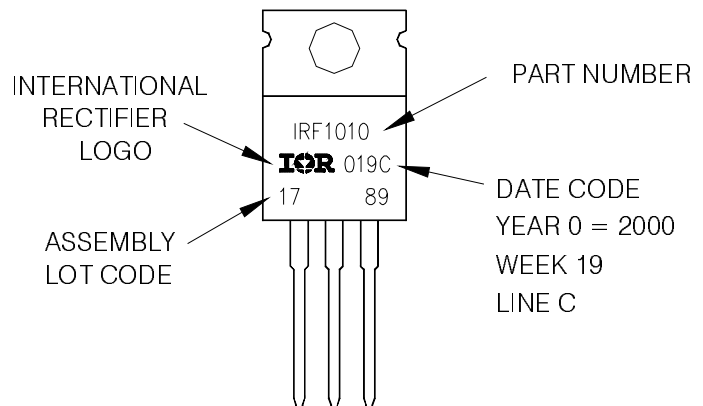

TO-220AB packages are not recommended for Surface Mount Application.



## TO-262 Package Outline

Dimensions are shown in millimeters (inches)

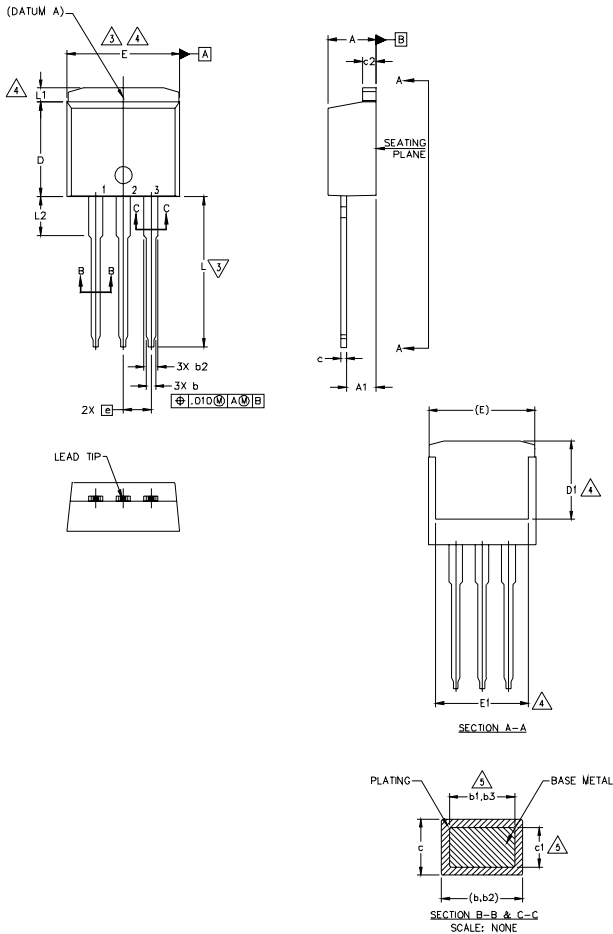

NOTES:

1. DIMENSIONING AND TOLERANCING PER ASME Y14.5M-1994
2. DIMENSIONS ARE SHOWN IN MILLIMETERS [INCHES].
3. DIMENSION D & E DO NOT INCLUDE MOLD FLASH. MOLD FLASH SHALL NOT EXCEED 0.127 [0.005"] PER SIDE. THESE DIMENSIONS ARE MEASURED AT THE OUTMOST EXTREMES OF THE PLASTIC BODY.
4. THERMAL PAD CONTOUR OPTIONAL WITHIN DIMENSION E, L1, D1 & E1.
5. DIMENSION b1 AND c1 APPLY TO BASE METAL ONLY.
6. CONTROLLING DIMENSION: INCH.
7. OUTLINE CONFORM TO JEDEC TO-262 EXCEPT A1(max.), b(min.) AND D1(min.) WHERE DIMENSIONS DERIVED THE ACTUAL PACKAGE OUTLINE.

SYMBOL	DIMENSIONS				NOTES
	MILLIMETERS		INCHES		
	MIN.	MAX.	MIN.	MAX.	
A	4.06	4.83	.160	.190	
A1	2.03	3.02	.080	.119	
b	0.51	0.99	.020	.039	
b1	0.51	0.89	.020	.035	5
b2	1.14	1.78	.045	.070	
b3	1.14	1.73	.045	.068	5
c	0.38	0.74	.015	.029	
c1	0.38	0.58	.015	.023	5
c2	1.14	1.65	.045	.065	
D	8.38	9.65	.330	.380	3
D1	6.86	-	.270	-	4
E	9.65	10.67	.380	.420	3,4
E1	6.22	-	.245	-	4
e	2.54 BSC		.100 BSC		
L	13.46	14.10	.530	.555	
L1	-	1.65	-	.065	4
L2	3.56	3.71	.140	.146	

LEAD ASSIGNMENTS

HEXFET

- 1.- GATE
- 2.- DRAIN
- 3.- SOURCE
- 4.- DRAIN

IGBTs, CoPACK

- 1.- GATE
- 2.- COLLECTOR
- 3.- EMITTER
- 4.- COLLECTOR

## TO-262 Part Marking Information

EXAMPLE: THIS IS AN IRL3103L  
LOT CODE 1789  
ASSEMBLED ON WW 19, 1997  
IN THE ASSEMBLY LINE "C"

Note: "P" in assembly line position indicates "Lead - Free"

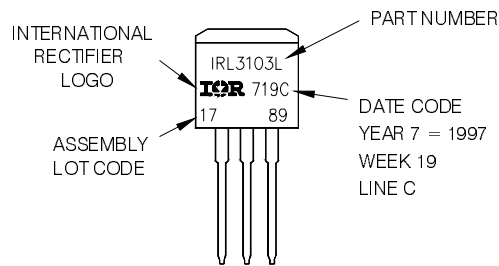

OR

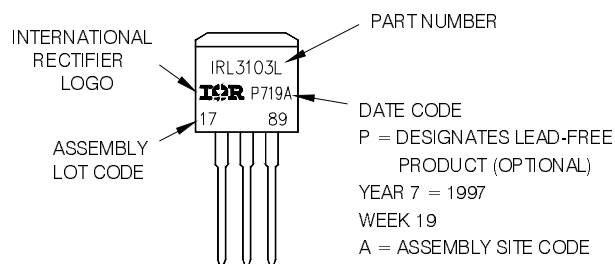

## D<sup>2</sup>Pak (TO-263AB) Package Outline

Dimensions are shown in millimeters (inches)

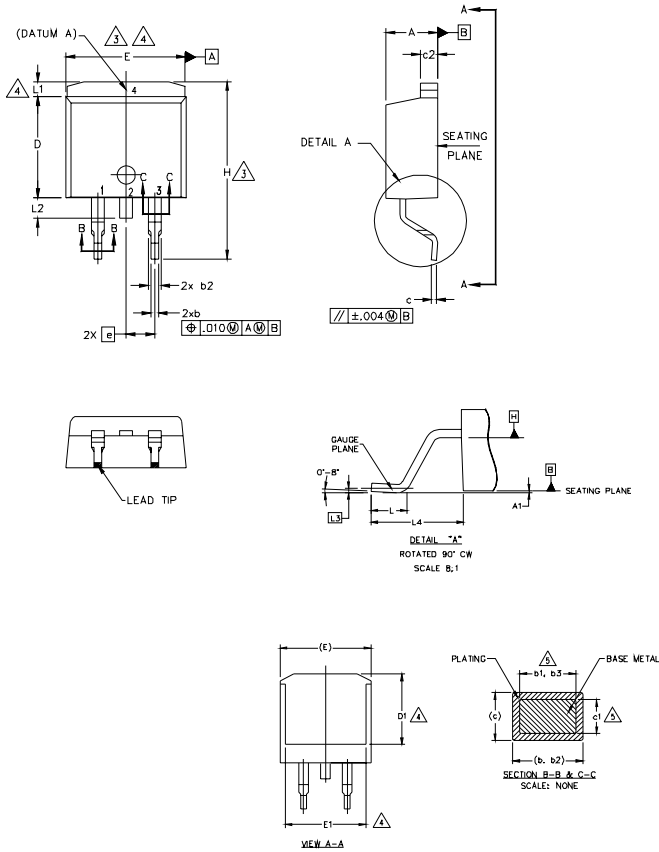

**NOTES:**

1. DIMENSIONING AND TOLERANCING PER ASME Y14.5M-1994
2. DIMENSIONS ARE SHOWN IN MILLIMETERS [INCHES].
3. DIMENSION D & E DO NOT INCLUDE MOLD FLASH. MOLD FLASH SHALL NOT EXCEED 0.127 [0.005"] PER SIDE. THESE DIMENSIONS ARE MEASURED AT THE OUTMOST EXTREMES OF THE PLASTIC BODY AT DATUM H.
4. THERMAL PAD CONTOUR OPTIONAL WITHIN DIMENSION E, L1, D1 & E1.
5. DIMENSION b1 AND c1 APPLY TO BASE METAL ONLY.
6. DATUM A & B TO BE DETERMINED AT DATUM PLANE H.
7. CONTROLLING DIMENSION: INCH.
8. OUTLINE CONFORMS TO JEDEC OUTLINE TO-263AB.

SYMBOL	DIMENSIONS				NOTES
	MILLIMETERS		INCHES		
	MIN.	MAX.	MIN.	MAX.	
A	4.06	4.83	.160	.190	5
A1	0.00	0.254	.000	.010	
b	0.51	0.99	.020	.039	
b1	0.51	0.89	.020	.035	
b2	1.14	1.78	.045	.070	
b3	1.14	1.73	.045	.068	
c	0.38	0.74	.015	.029	
c1	0.38	0.58	.015	.023	
c2	1.14	1.65	.045	.065	
D	8.38	9.65	.330	.380	
D1	6.86	-	.270	-	4
E	9.65	10.67	.380	.420	3,4
E1	6.22	-	.245	-	4
e	2.54 BSC		.100 BSC		
H	14.61	15.88	.575	.625	4
L	1.78	2.79	.070	.110	
L1	-	1.65	-	.066	
L2	1.27	1.78	-	.070	
L3	0.25 BSC		.010 BSC		
L4	4.78	5.28	.188	.208	

**LEAD ASSIGNMENTS**

HEXFET

- 1.- GATE
- 2, 4.- DRAIN
- 3.- SOURCE

IGBTs, CoPACK

- 1.- GATE
- 2, 4.- COLLECTOR
- 3.- EMITTER

DIODES

- 1.- ANODE \*
- 2, 4.- CATHODE
- 3.- ANODE

\* PART DEPENDENT.

## D<sup>2</sup>Pak (TO-263AB) Part Marking Information

EXAMPLE: THIS IS AN IRF530S WITH  
LOT CODE 8024  
ASSEMBLED ON WW 02, 2000  
IN THE ASSEMBLY LINE "L"

Note: "P" in assembly line position  
indicates "Lead - Free"

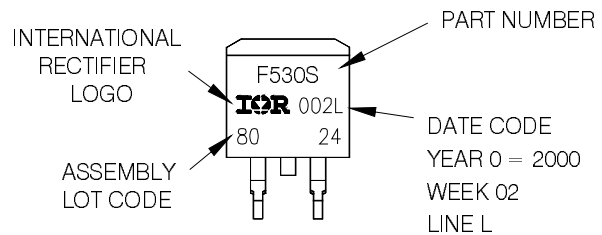

OR

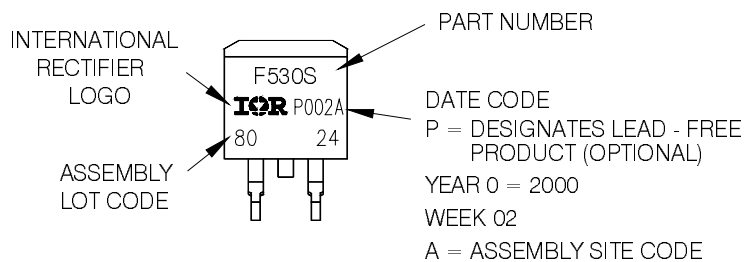

D<sup>2</sup>Pak (TO-263AB) Tape & Reel Information

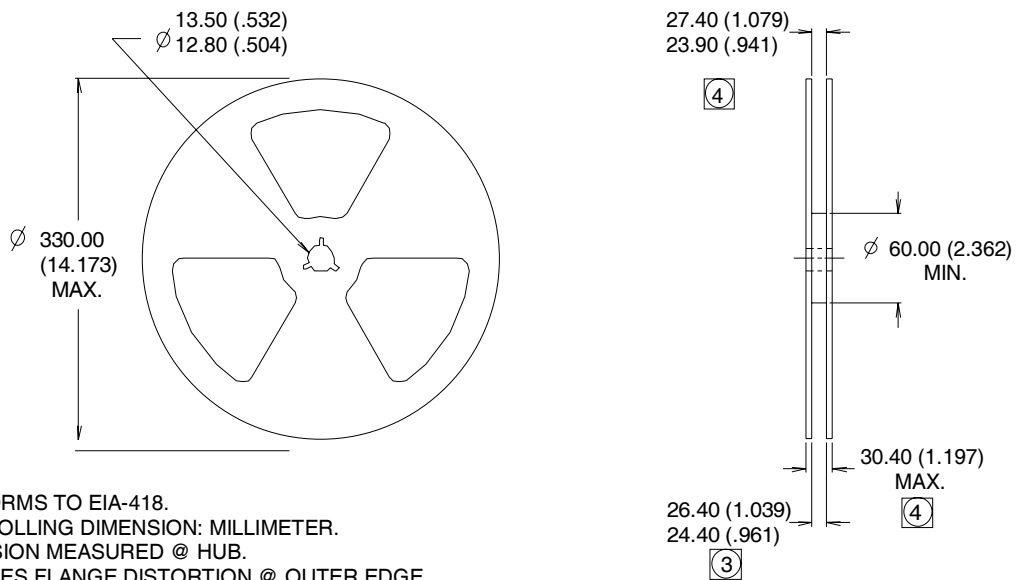
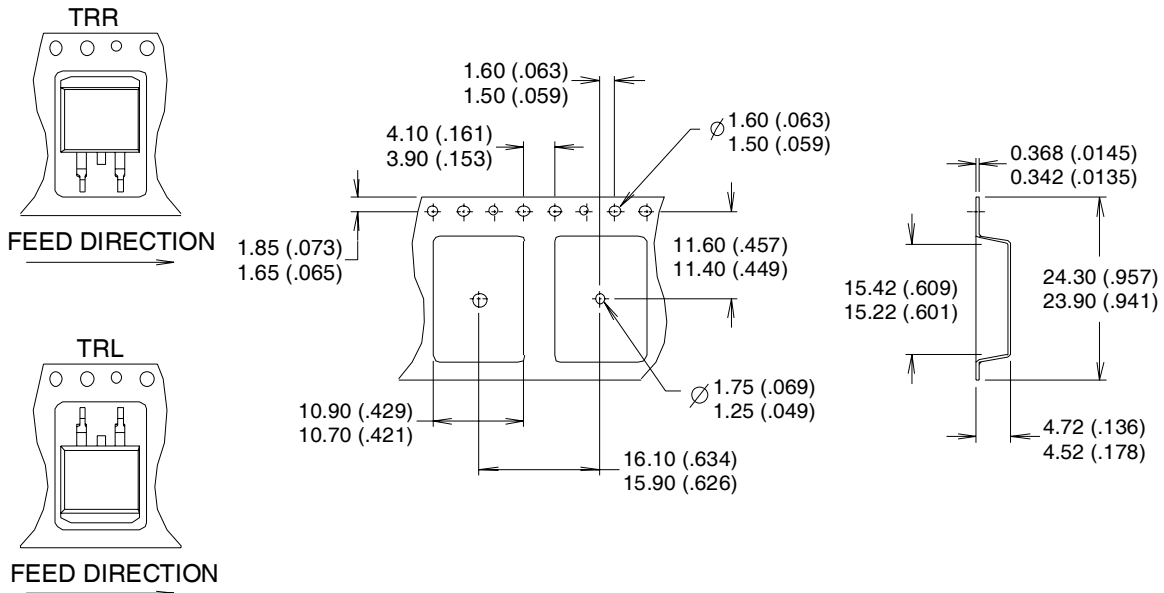

Data and specifications subject to change without notice.  
This product has been designed and qualified for the Industrial market.  
Qualification Standards can be found on IR's Web site.

Note: For the most current drawings please refer to the IR website at:  
<http://www.irf.com/package/>

## **IMPORTANT NOTICE**

The information given in this document shall in no event be regarded as a guarantee of conditions or characteristics ("Beschaffenhheitsgarantie").

With respect to any examples, hints or any typical values stated herein and/or any information regarding the application of the product, Infineon Technologies hereby disclaims any and all warranties and liabilities of any kind, including without limitation warranties of non-infringement of intellectual property rights of any third party.

In addition, any information given in this document is subject to customer's compliance with its obligations stated in this document and any applicable legal requirements, norms and standards concerning customer's products and any use of the product of Infineon Technologies in customer's applications.

The data contained in this document is exclusively intended for technically trained staff. It is the responsibility of customer's technical departments to evaluate the suitability of the product for the intended application and the completeness of the product information given in this document with respect to such application.

For further information on the product, technology, delivery terms and conditions and prices please contact your nearest Infineon Technologies office ([www.infineon.com](http://www.infineon.com)).

## **WARNINGS**

Due to technical requirements products may contain dangerous substances. For information on the types in question please contact your nearest Infineon Technologies office.

Except as otherwise explicitly approved by Infineon Technologies in a written document signed by authorized representatives of Infineon Technologies, Infineon Technologies' products may not be used in any applications where a failure of the product or any consequences of the use thereof can reasonably be expected to result in personal injury.