

MKDSP 25/ 6-15,00 - PCB terminal block



1932627

<https://www.phoenixcontact.com/us/products/1932627>

Please be informed that the data shown in this PDF document is generated from our online catalog. Please find the complete data in the user documentation. Our general terms of use for downloads are valid.

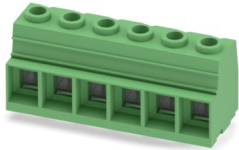

Printed circuit board terminal, nominal current: 125 A, rated voltage (III/2): 1000 V, nominal cross section: 35 mm², number of potentials: 6, number of rows: 1, number of positions per row: 6, product range: MKDSP 25, pitch: 15 mm, connection method: Screw connection with tension sleeve, screw head form: Z2L Slotted Pozidriv, mounting: Wave soldering, conductor/PCB connection direction: 0 °, color: green, Pin layout: Linear pinning, Solder pin [P]: 4.5 mm, number of solder pins per potential: 4, type of packaging: packed in cardboard. Avoid placing permanent mechanical loads on the terminal

Your advantages

- Well-known connection principle allows worldwide use
- Low temperature rise, thanks to maximum contact force
- Allows connection of two conductors
- Quick and convenient testing using integrated test option
- Integrated protective guide prevents incorrect insertion of the conductor underneath the tension sleeve

Commercial data

Item number	1932627
Packing unit	10 pc
Minimum order quantity	10 pc
Note	Made to order (non-returnable)
Sales key	AA15
Product key	AAOIAA
GTIN	4017918902124
Weight per piece (including packing)	127 g
Weight per piece (excluding packing)	126.92 g
Customs tariff number	85369010
Country of origin	SK

MKDSP 25/ 6-15,00 - PCB terminal block



1932627

<https://www.phoenixcontact.com/us/products/1932627>

Technical data

Product properties

Product type	Printed circuit board terminal
Product family	MKDSP 25
Product line	COMBICON Terminals XL
Type	Standard
Number of positions	6
Pitch	15 mm
Number of connections	6
Number of rows	1
Number of potentials	6
Pin layout	Linear pinning
Solder pins per potential	4

Electrical properties

Properties

Nominal current I_N	125 A
Nominal voltage U_N	1000 V
Rated voltage (III/3)	1000 V
Rated surge voltage (III/3)	8 kV
Rated voltage (III/2)	1000 V
Rated surge voltage (III/2)	8 kV
Rated voltage (II/2)	1000 V
Rated surge voltage (II/2)	8 kV

Connection data

Connection technology

Type	Standard
Nominal cross section	35 mm ²

Conductor connection

Connection method	Screw connection with tension sleeve
Conductor cross-section rigid	0.5 mm ² ... 35 mm ²
Conductor cross-section flexible	0.5 mm ² ... 35 mm ²
Conductor cross-section AWG	20 ... 2
Conductor cross-section flexible, with ferrule without plastic sleeve	1 mm ² ... 35 mm ²
Conductor cross-section, flexible, with ferrule, with plastic sleeve	1.5 mm ² ... 35 mm ²
2 conductors with same cross section, solid	0.5 mm ² ... 6 mm ²
2 conductors with same cross section, flexible	0.5 mm ² ... 6 mm ²
2 conductors with same cross section, flexible, with ferrule without plastic sleeve	0.5 mm ² ... 4 mm ²

MKDSP 25/ 6-15,00 - PCB terminal block



1932627

<https://www.phoenixcontact.com/us/products/1932627>

2 conductors with the same cross section, flexible, with TWIN ferrule with plastic sleeve	0.5 mm ² ... 16 mm ²
Stripping length	18 mm
Drive form screw head	Slotted Pozidriv (Z2L)
Tightening torque	2.5 Nm ... 4.5 Nm (< 25 mm ² = 2.5 Nm, ≥ 25 mm ² = 4.5 Nm)

Information on the aluminum conductor

Cross section / torque / form of conductor	Cable cross section:35 mm ² ; Torque:4.5 Nm; Form of cable:round, single-strand, class 1(re)
Specification	DIN VDE 0276-603 (VDE 0276-603):2010-03
Note on conductor pretreatment	The following measures are required for durable and reliable contacting of the aluminum conductor: the stripped end of the aluminum conductor must be separated from the oxide layer using a blade, and immediately dipped in non-acid and non-alkali Vaseline. The pretreatment must be repeated when connecting the conductors anew.

Mounting

Mounting type	Wave soldering
Pin layout	Linear pinning

Material specifications

Material data - contact

Note	WEEE/RoHS-compliant, free of whiskers according to IEC 60068-2-82/JEDEC JESD 201
Contact material	Cu alloy
Surface characteristics	Tin-plated
Metal surface terminal point (top layer)	Tin (5 - 7 μm Sn)
Metal surface soldering area (top layer)	Tin (5 - 7 μm Sn)

Material data - housing

Color (Housing)	green (6021)
Insulating material	PA
Insulating material group	I
CTI according to IEC 60112	600
Flammability rating according to UL 94	V0
Glow wire flammability index GWFI according to EN 60695-2-12	850
Glow wire ignition temperature GWIT according to EN 60695-2-13	775
Temperature for the ball pressure test according to EN 60695-10-2	125 °C

Dimensions

MKDSP 25/ 6-15,00 - PCB terminal block



1932627

<https://www.phoenixcontact.com/us/products/1932627>

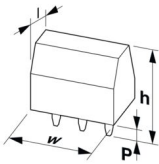
Dimensional drawing	
Pitch	15 mm
Width [w]	90 mm
Height [h]	43.5 mm
Length [l]	31 mm
Installed height	39 mm
Solder pin length [P]	4.5 mm
Pin dimensions	1.2 x 1.2 mm

PCB design

Hole diameter	1.6 mm
---------------	--------

Mechanical tests

Test for conductor damage and slackening

Specification	IEC 60999-1:1999-11
Result	Test passed

Pull-out test

Specification	IEC 60999-1:1999-11
Conductor cross-section/conductor type/tractive force setpoint/actual value	0.5 mm ² / solid / > 20 N
	0.5 mm ² / flexible / > 20 N
	35 mm ² / stranded / > 190 N
	35 mm ² / flexible / > 190 N

Electrical tests

Temperature-rise test

Specification	IEC 60947-7-4:2013-08
Requirement temperature-rise test	The sum of ambient temperature and temperature rise of the PCB terminal block shall not exceed the upper limiting temperature.

Short-time withstand current

Specification	IEC 60947-7-4:2013-08
---------------	-----------------------

Insulation resistance

Specification	IEC 60512-3-1:2002-02
Insulation resistance, neighboring positions	> 5 MΩ

Air clearances and creepage distances |

Specification	IEC 60947-1:2007-06 + A1:2010-12
Insulating material group	I

MKDSP 25/ 6-15,00 - PCB terminal block



1932627

<https://www.phoenixcontact.com/us/products/1932627>

Comparative tracking index (IEC 60112)	CTI 600
Rated insulation voltage (III/3)	1000 V
Rated surge voltage (III/3)	8 kV
minimum clearance value - non-homogenous field (III/3)	8 mm
minimum creepage distance (III/3)	12.5 mm
Rated insulation voltage (III/2)	1000 V
Rated surge voltage (III/2)	8 kV
minimum clearance value - non-homogenous field (III/2)	8 mm
minimum creepage distance (III/2)	8 mm
Rated insulation voltage (II/2)	1000 V
Rated surge voltage (II/2)	8 kV
minimum clearance value - non-homogenous field (II/2)	8 mm
minimum creepage distance (II/2)	8 mm

Environmental and real-life conditions

Vibration test

Specification	IEC 60068-2-6:2007-12
Frequency	10 - 150 - 10 Hz
Sweep speed	1 octave/min
Amplitude	0.35 mm (10 Hz ... 60.1 Hz)
Acceleration	5g (60.1 Hz ... 150 Hz)
Test duration per axis	2.5 h
Test directions	X-, Y- and Z-axis

Glow-wire test

Specification	IEC 60695-2-10:2000-10
Temperature	850 °C
Time of exposure	5 s

Aging

Specification	IEC 60947-7-4:2013-08
---------------	-----------------------

Ambient conditions

Ambient temperature (operation)	-40 °C ... 100 °C (Depending on the current carrying capacity/derating curve)
Ambient temperature (storage/transport)	-40 °C ... 70 °C
Relative humidity (storage/transport)	30 % ... 70 %
Ambient temperature (assembly)	-5 °C ... 100 °C

Packaging specifications

Type of packaging	packed in cardboard
-------------------	---------------------

Drawings

Dimensional drawing

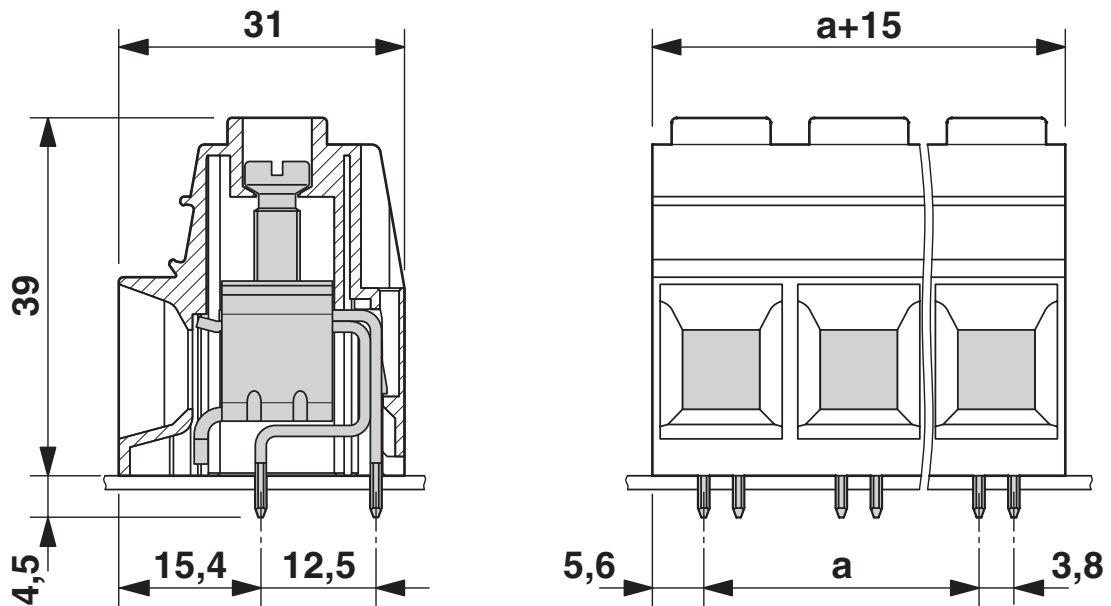

Diagram

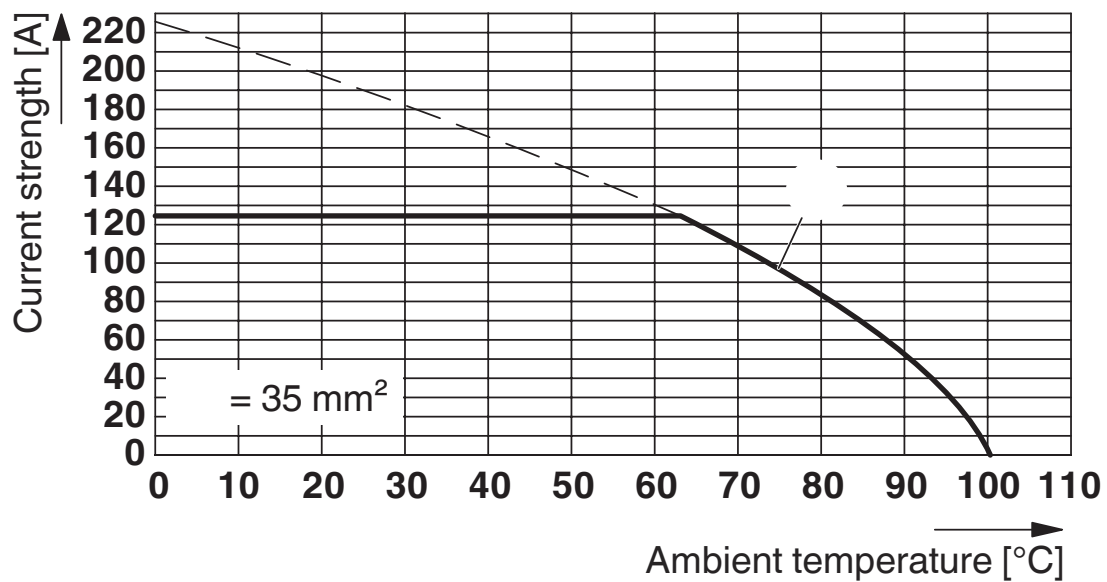

Type: MKDSP 25/...-15,00(-F)

MKDSP 25/ 6-15,00 - PCB terminal block

1932627

<https://www.phoenixcontact.com/us/products/1932627>



Drilling plan/solder pad geometry

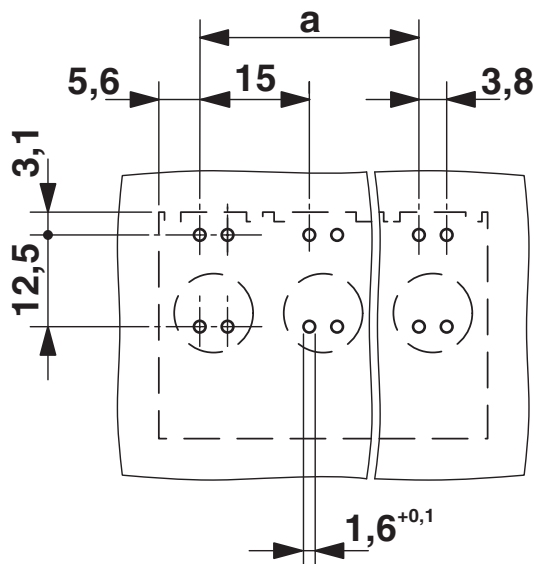

MKDSP 25/ 6-15,00 - PCB terminal block





1932627

<https://www.phoenixcontact.com/us/products/1932627>

Approvals

To download certificates, visit the product detail page: <https://www.phoenixcontact.com/us/products/1932627>

 cULus Recognized Approval ID: E60425-19770427				
	Nominal voltage U_N	Nominal current I_N	Cross section AWG	Cross section mm^2
B	600 V	115 A	20 - 2	-
C	600 V	115 A	20 - 2	-

 VDE approval of drawings Approval ID: 40041859				
	Nominal voltage U_N	Nominal current I_N	Cross section AWG	Cross section mm^2
keine	1000 V	125 A	-	0.5 - 35

MKDSP 25/ 6-15,00 - PCB terminal block



1932627

<https://www.phoenixcontact.com/us/products/1932627>

Classifications

ECLASS

ECLASS-13.0	27460101
ECLASS-15.0	27460101

ETIM

ETIM 9.0	EC002643
----------	----------

UNSPSC

UNSPSC 21.0	39121400
-------------	----------

MKDSP 25/ 6-15,00 - PCB terminal block



1932627

<https://www.phoenixcontact.com/us/products/1932627>

Environmental product compliance

EU RoHS

Fulfills EU RoHS substance requirements	Yes, No exemptions
---	--------------------

China RoHS

Environment friendly use period (EFUP)	EFUP-E
	No hazardous substances above the limits

EU REACH SVHC

REACH candidate substance (CAS No.)	No substance above 0.1 wt%
-------------------------------------	----------------------------

Phoenix Contact 2025 © - all rights reserved
<https://www.phoenixcontact.com>

Phoenix Contact USA
586 Fulling Mill Road
Middletown, PA 17057, United States
(+717) 944-1300
info@phoenixcon.com