

# REL-MR- 12DC/21HC - Single relay



2961309

<https://www.phoenixcontact.com/us/products/2961309>

Please be informed that the data shown in this PDF document is generated from our online catalog. Please find the complete data in the user documentation. Our general terms of use for downloads are valid.



Plug-in miniature power relay, with power contact for high continuous currents, 1 changeover contact, input voltage 12 V DC

## Your advantages

- Switching current of up to 16 A

## Commercial data

Item number	2961309
Packing unit	10 pc
Minimum order quantity	10 pc
Sales key	C460
Product key	DK6931
GTIN	4017918187552
Weight per piece (including packing)	16.816 g
Weight per piece (excluding packing)	15.7 g
Customs tariff number	85364900
Country of origin	AT

# REL-MR- 12DC/21HC - Single relay



2961309

<https://www.phoenixcontact.com/us/products/2961309>

## Technical data

### Product properties

Product type	Single relay
Operating mode	100% operating factor
Mechanical service life	3x 10 <sup>7</sup> cycles

### Insulation characteristics

Overvoltage category	III
Pollution degree	3

### Data management status

Date of last data management	25.08.2025
------------------------------	------------

### Electrical properties

Service life electrical	see diagram
Maximum power dissipation for nominal condition	0.4 W
Test voltage (Winding/contact)	5 kV AC (50 Hz, 1 min., winding/contact)

### Input data

#### Coil side

Nominal input voltage $U_N$	12 V DC
Input voltage range	7.8 V DC ... 28.8 V DC
Input voltage range in reference to $U_N$	see diagram
Drive and function	monostable
Drive (polarity)	non-polarized
Typical input current at $U_N$	33 mA
Typical response time	7 ms
Typical release time	3 ms
Coil resistance	360 $\Omega$ $\pm$ 10 % (at 20 °C)

### Output data

#### Switching

Contact switching type	1 changeover contact
Type of switch contact	Single contact
Contact material	AgNi
Maximum switching voltage	250 V AC/DC
Minimum switching voltage	12 V (at 10 mA)
Limiting continuous current	16 A
Maximum inrush current	50 A (20 ms)
Min. switching current	10 mA (at 12 V)
Interrupting rating (ohmic load) max.	384 W (at 24 V DC) 58 W (at 48 V DC)

# REL-MR- 12DC/21HC - Single relay



2961309

<https://www.phoenixcontact.com/us/products/2961309>

	48 W (at 60 V DC)
	50 W (at 110 V DC)
	80 W (at 220 V DC)
	4000 VA (for 250 V AC)
Switching capacity	2 A (at 24 V, DC13)
	0.2 A (at 110 V, DC13)
	0.2 A (at 250 V, DC13)
	6 A (at 24 V, AC15)
	6 A (at 120 V, AC15)
	6 A (at 250 V, AC15)
Motor load according to UL 508	1/2 HP, 120 V AC (N/O contact)
	1 HP, 240 V AC (N/O contact)
	1/3 HP, 120 V AC (N/C contact)
	3/4 HP, 240 V AC (N/C contact)
	1/4 HP, 200 ... 250 V AC

## Connection data

Connection method	Plug / solder connection
-------------------	--------------------------

## Dimensions

Dimensional drawing	
Width	12.7 mm
Height	29 mm
Depth	15.7 mm

## Material specifications

Color	white (RAL 9010)
-------	------------------

## Environmental and real-life conditions

### Ambient conditions

Degree of protection	RT II
Ambient temperature (operation)	-40 °C ... 85 °C
Ambient temperature (storage/transport)	-40 °C ... 85 °C

## Approvals

### Corrosive gas test

Identification	ISA-S71.04. G3 Harsh Group
	EN 60068-2-60

## Standards and regulations

# REL-MR- 12DC/21HC - Single relay



2961309

<https://www.phoenixcontact.com/us/products/2961309>

Standards/regulations	IEC 60664
	EN 50178
	EN 61810-1

## Mounting

Assembly note	Can be aligned without spacing ( $> 70\text{ °C} \geq 2.5\text{ mm}$ )
Mounting position	any

## Drawings

Dimensional drawing

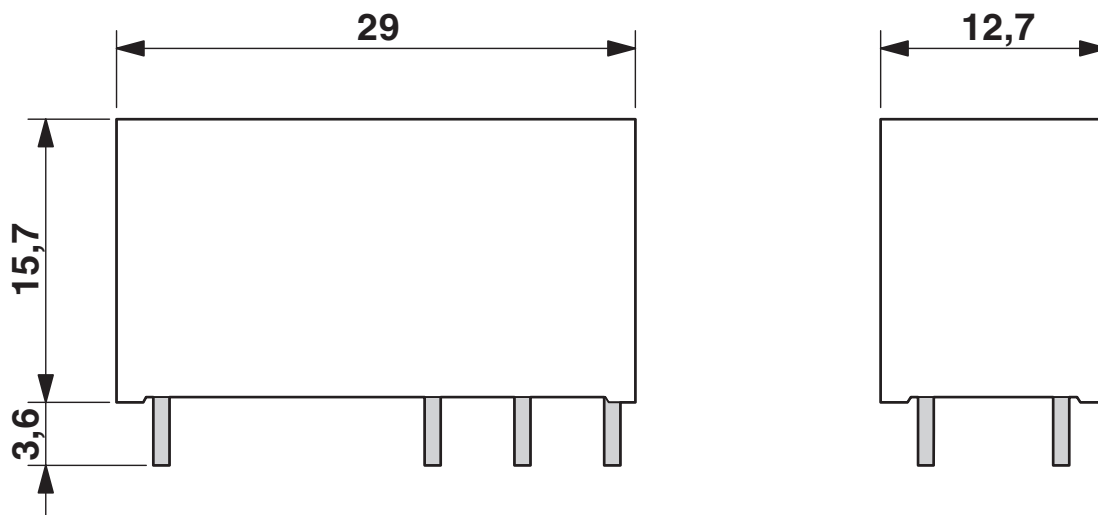

Diagram

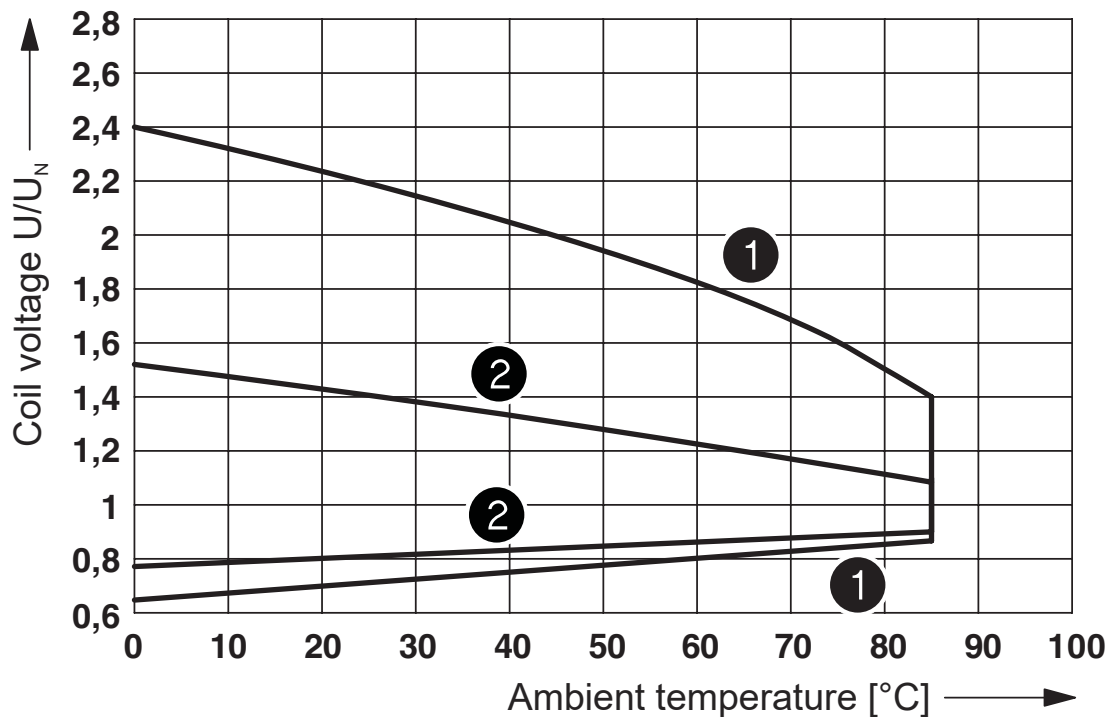

- ① DC coils
- ② AC coils

Operating voltage range

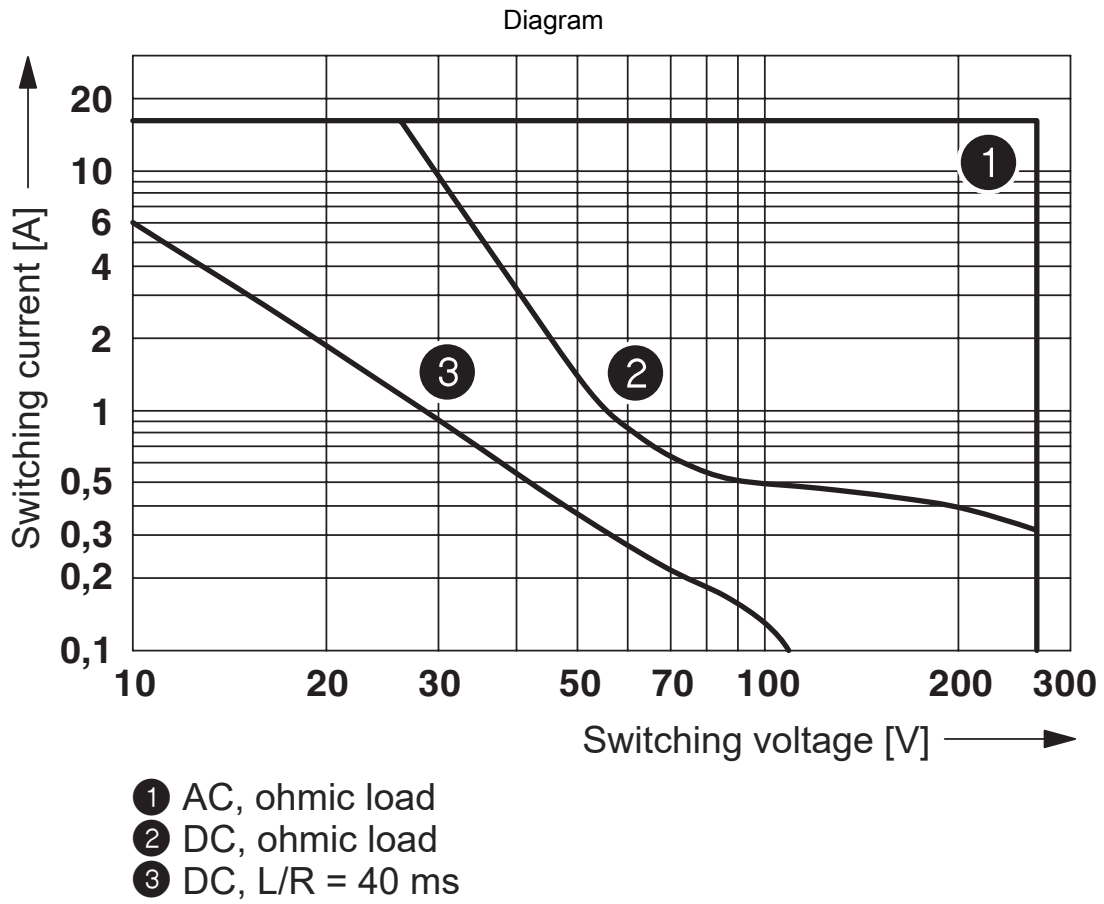

Interrupting rating

# REL-MR- 12DC/21HC - Single relay



2961309

<https://www.phoenixcontact.com/us/products/2961309>

Diagram

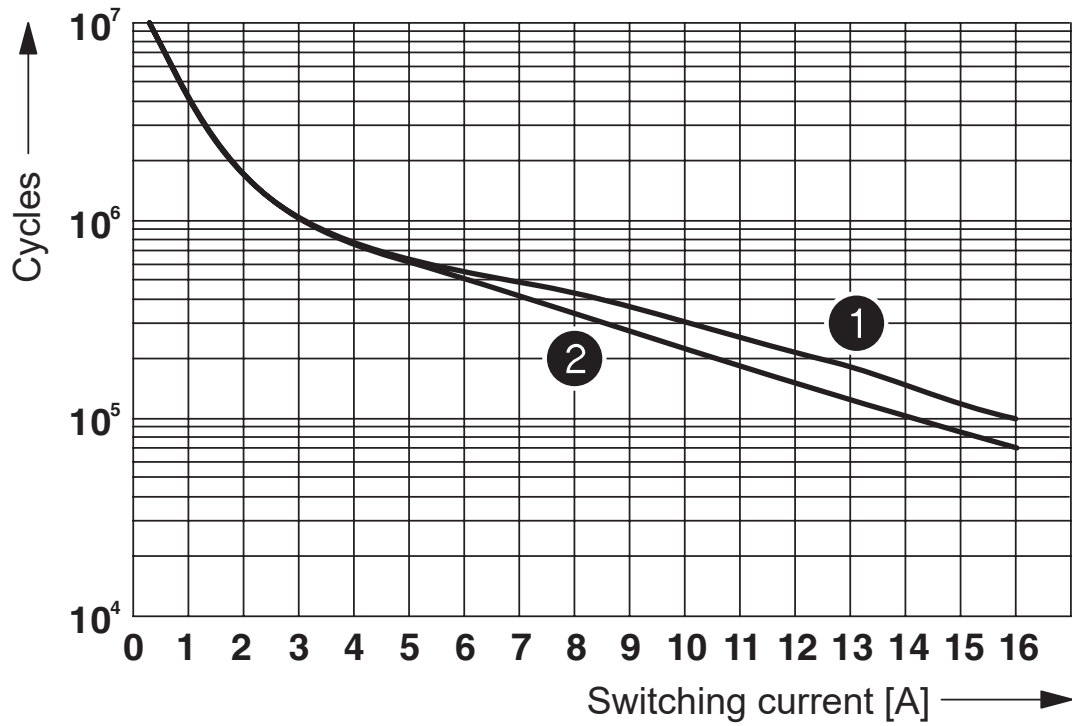

- ① 250 V AC, ohmic load (DC coils)
- ② 250 V AC, ohmic load (AC coils)

Electrical service life

Diagram

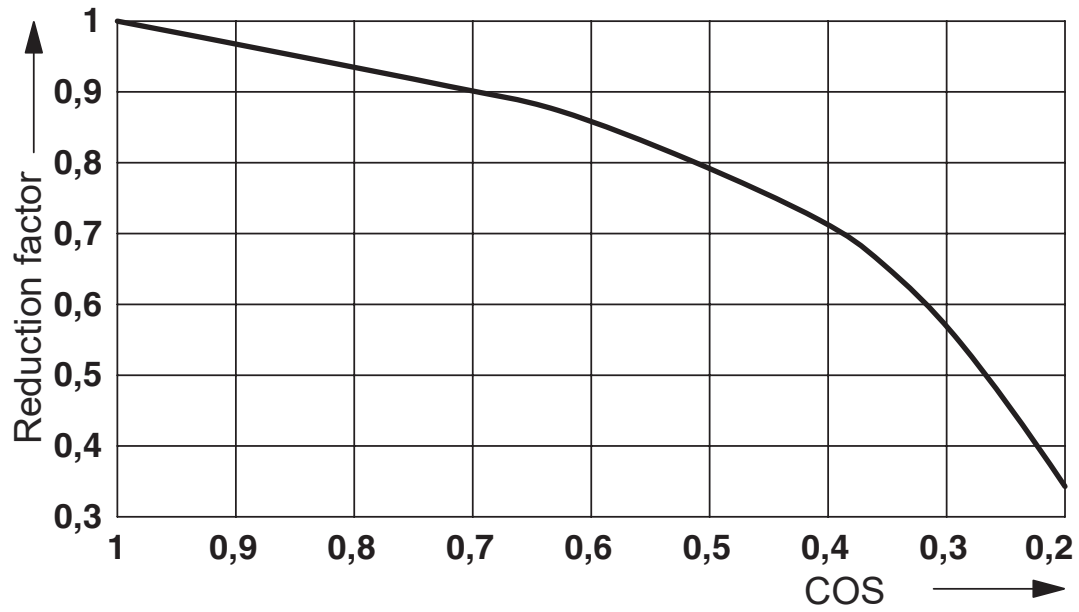

Service life reduction factor with various cos phi



Diagram

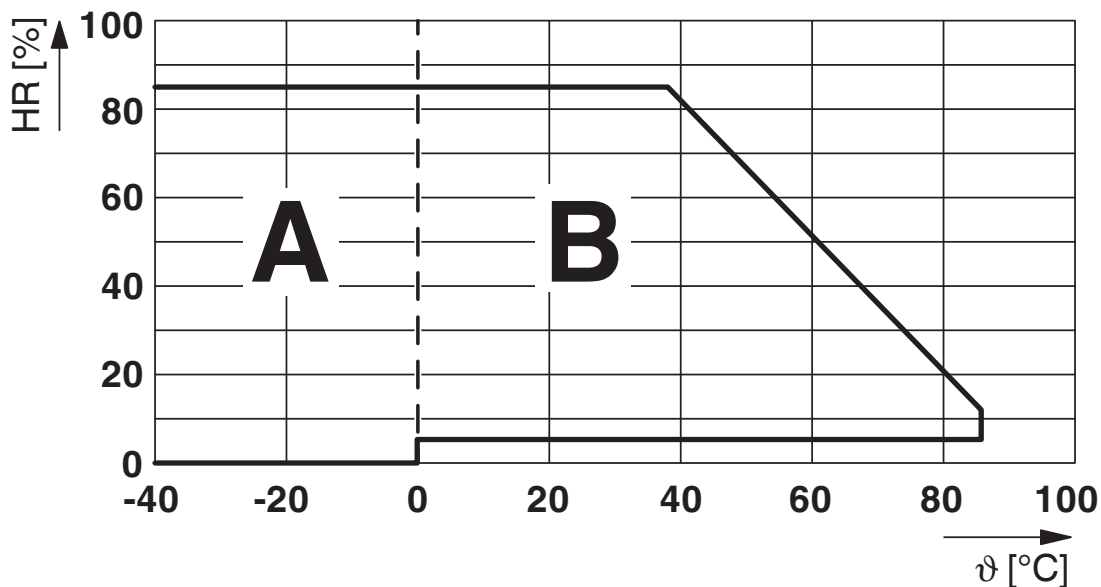

Permissible humidity for operation and storage.

The maximum permissible ambient temperature as specified in the data sheet must be observed.

Area A: Ice buildup at ambient temperatures  $\leq 0^{\circ}\text{C}$  must be prevented

Area B: Condensation at ambient temperatures  $> 0^{\circ}\text{C}$  must be prevented

On 30 full days that are naturally distributed across an entire year, a humidity level of 95% is permissible at an ambient temperature  $\leq 25^{\circ}\text{C}$ .

Circuit diagram

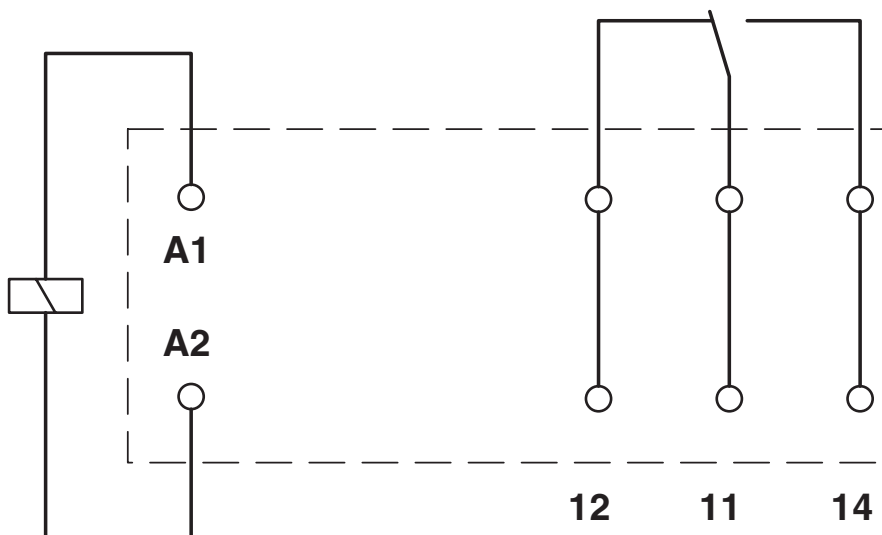

# REL-MR- 12DC/21HC - Single relay



2961309

<https://www.phoenixcontact.com/us/products/2961309>

Drilling plan/solder pad geometry

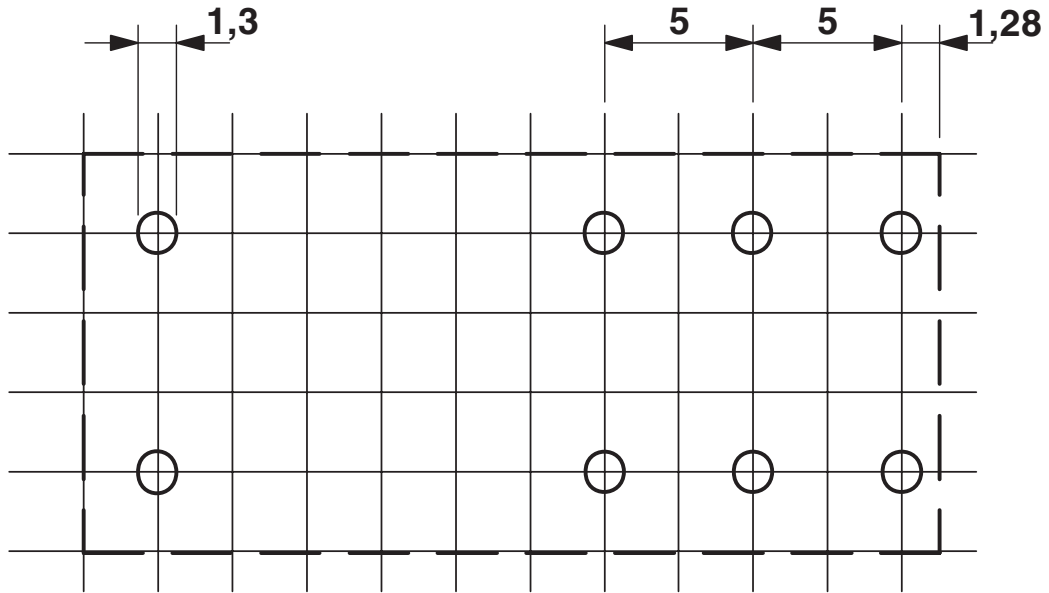

a = pitch division 2.5 mm

# REL-MR- 12DC/21HC - Single relay



2961309

<https://www.phoenixcontact.com/us/products/2961309>

## Approvals

To download certificates, visit the product detail page: <https://www.phoenixcontact.com/us/products/2961309>



**cUL Recognized**  
Approval ID: FILE E 228652



**UL Recognized**  
Approval ID: FILE E 228652



**EAC**  
Approval ID: RU\*C-DE.\*08.B.00010



**UL Recognized**  
Approval ID: FILE E 228652



**VDE Zeichengenehmigung**  
Approval ID: 40048281



**VDE Zeichengenehmigung**  
Approval ID: 40007758



**cUL Recognized**  
Approval ID: FILE E 228652



**cULus Recognized**  
Approval ID: E172140

# REL-MR- 12DC/21HC - Single relay



2961309

<https://www.phoenixcontact.com/us/products/2961309>

## Classifications

### ECLASS

ECLASS-13.0	27371601
ECLASS-15.0	27371601

### ETIM

ETIM 9.0	EC001437
----------	----------

### UNSPSC

UNSPSC 21.0	39122300
-------------	----------

# REL-MR- 12DC/21HC - Single relay



2961309

<https://www.phoenixcontact.com/us/products/2961309>

## Environmental product compliance

### EU RoHS

Fulfills EU RoHS substance requirements	Yes, No exemptions
---	--------------------

### China RoHS

Environment friendly use period (EFUP)	EFUP-E
	No hazardous substances above the limits

### EU REACH SVHC

REACH candidate substance (CAS No.)	No substance above 0.1 wt%
-------------------------------------	----------------------------

Phoenix Contact 2025 © - all rights reserved  
<https://www.phoenixcontact.com>

Phoenix Contact USA  
586 Fulling Mill Road  
Middletown, PA 17057, United States  
(+717) 944-1300  
[info@phoenixcon.com](mailto:info@phoenixcon.com)