

DD32PC 2,2/12-5,08-XY - PCB connector



1378220

<https://www.phoenixcontact.com/us/products/1378220>

Please be informed that the data shown in this PDF document is generated from our online catalog. Please find the complete data in the user documentation. Our general terms of use for downloads are valid.

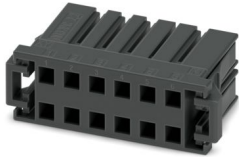

PCB connector, color: black, nominal current: 8 A, rated voltage (III/2): 320 V, contact surface: Sn, contact connection type: Socket, number of rows: 2, number of positions: 12, product range: DD32PC 2,2/..., pitch: 5.08 mm, connection method: Crimp connection, conductor/PCB connection direction: 0 °, locking clip: - without locking clip, plug-in system: CONNEXIS DD, locking: Snap-in locking, mounting method: Latching flange, type of packaging: packed in cardboard

Your advantages

- Cost-effective connection of crimped conductors in large quantities
- Small component size for applications where space is at a premium
- Contacts arranged in a double row enable high packing density in a compact area
- Intuitive locking mechanism prevents accidental disconnection
- Tools for automatic crimping available as an option

Commercial data

Item number	1378220
Packing unit	50 pc
Minimum order quantity	50 pc
Note	Made to order (non-returnable)
Sales key	AA03
Product key	AACCUF
GTIN	4063151745967
Weight per piece (including packing)	8.075 g
Weight per piece (excluding packing)	9.75 g
Customs tariff number	85366990
Country of origin	CN

DD32PC 2,2/12-5,08-XY - PCB connector



1378220

<https://www.phoenixcontact.com/us/products/1378220>

Technical data

Product properties

Product type	PCB connector
Product family	DD32PC 2,2/..
Product line	CONNEXIS Connectors M
Number of positions	12
Pitch	5.08 mm
Number of rows	2

Electrical properties

Properties

Nominal current I_N	8 A
Nominal voltage U_N	320 V
Contact resistance	0.9 m Ω
Rated voltage (III/3)	250 V
Rated surge voltage (III/3)	4 kV
Rated voltage (III/2)	320 V
Rated surge voltage (III/2)	4 kV
Rated voltage (II/2)	500 V
Rated surge voltage (II/2)	4 kV

Connection data

Interlock

Locking type	Snap-in locking
Mounting type	Latching flange

Conductor connection

Connection method	Crimp connection
Conductor/PCB connection direction	0 °
Conductor cross-section AWG	28 ... 14
Stripping length	4.5 mm

Material specifications

Material data - contact

Metal surface contact area (top layer)	Tin (Sn)
--	----------

Material data - housing

Color (Housing)	black (9005)
Insulating material	PBT
Insulating material group	II
CTI according to IEC 60112	400 ≤ CTI < 600
Flammability rating according to UL 94	V0

DD32PC 2,2/12-5,08-XY - PCB connector



1378220

<https://www.phoenixcontact.com/us/products/1378220>

Dimensions

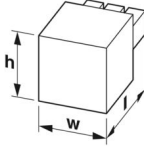
Dimensional drawing	
Pitch	5.08 mm
Width [w]	42.54 mm
Height [h]	14.77 mm
Length [l]	22.8 mm

Notes

Note on the contact	These connectors conform to DIN EN 61984, connectors without switching capacity (COC). When used for their intended purpose, they must not be plugged in or disconnected live or under load.
---------------------	--

Mechanical tests

Tensile strength of crimp connections

Result	Test passed
Conductor cross-section/conductor type/tractive force setpoint/actual value	AWG 28 / flexible / > 11 N

Insertion and withdrawal forces

Specification	IEC 60512-13-2:2006-02
Result	Test passed
No. of cycles	25
Insertion strength per pos. approx.	3 N
Withdraw strength per pos. approx.	4 N

Resistance of inscriptions

Specification	IEC 60068-2-70:1995-12
Result	Test passed

Polarization and coding

Specification	IEC 60512-13-5:2006-02
Result	Test passed

Visual inspection

Specification	IEC 60512-1-1:2002-02
Result	Test passed

Dimension check

Specification	IEC 60512-1-2:2002-02
Result	Test passed

1378220

<https://www.phoenixcontact.com/us/products/1378220>

Environmental and real-life conditions

Vibration test

Specification	IEC 60068-2-6:2007-12
Frequency	10 - 150 - 10 Hz
Sweep speed	1 octave/min
Amplitude	0.35 mm (10 Hz ... 60.1 Hz)
Acceleration	50 m/s ² (60.1 Hz ... 150 Hz)
Test duration per axis	2.5 h
Test directions	X-, Y- and Z-axis

Durability test

Specification	IEC 60512-9-1:2010-03
Impulse withstand voltage at sea level	4.8 kV
Contact resistance R ₁	0.9 mΩ
Contact resistance R ₂	1 mΩ
Insertion/withdrawal cycles	25

Climatic test

Specification	ISO 6988:1985-02
Corrosive stress	0.2 dm ³ SO ₂ on 300 dm ³ /40 °C/1 cycle
Thermal stress	105 °C/168 h
Power-frequency withstand voltage	2.21 kV

Shocks

Specification	IEC 60068-2-27:2008-02
Pulse shape	Half-sine
Acceleration	30g
Shock duration	11 ms
Test directions	X-, Y- and Z-axis (pos. and neg.)

Ambient conditions

Ambient temperature (operation)	-55 °C ... 105 °C (dependent on the derating curve)
Ambient temperature (storage/transport)	-40 °C ... 70 °C
Relative humidity (storage/transport)	30 % ... 70 %
Ambient temperature (assembly)	-5 °C ... 100 °C

Electrical tests

Thermal test | Test group C

Specification	IEC 60512-5-1:2002-02
Tested number of positions	20

Insulation resistance

Specification	IEC 60512-3-1:2002-02
Insulation resistance, neighboring positions	> 5 MΩ

DD32PC 2,2/12-5,08-XY - PCB connector



1378220

<https://www.phoenixcontact.com/us/products/1378220>

Air clearances and creepage distances |

Specification	IEC 60664-1:2020-05
Insulating material group	II
Comparative tracking index (IEC 60112)	CTI ≥ 400 to < 600
Rated insulation voltage (III/3)	250 V
Rated surge voltage (III/3)	4 kV
minimum clearance value - non-homogenous field (III/3)	3 mm
minimum creepage distance (III/3)	3.6 mm
Rated insulation voltage (III/2)	320 V
Rated surge voltage (III/2)	4 kV
minimum clearance value - non-homogenous field (III/2)	3 mm
minimum creepage distance (III/2)	3 mm
Rated insulation voltage (II/2)	500 V
Rated surge voltage (II/2)	4 kV
minimum clearance value - non-homogenous field (II/2)	3 mm
minimum creepage distance (II/2)	3.6 mm

Packaging specifications

Type of packaging	packed in cardboard
-------------------	---------------------

1378220

<https://www.phoenixcontact.com/us/products/1378220>

Drawings

Diagram

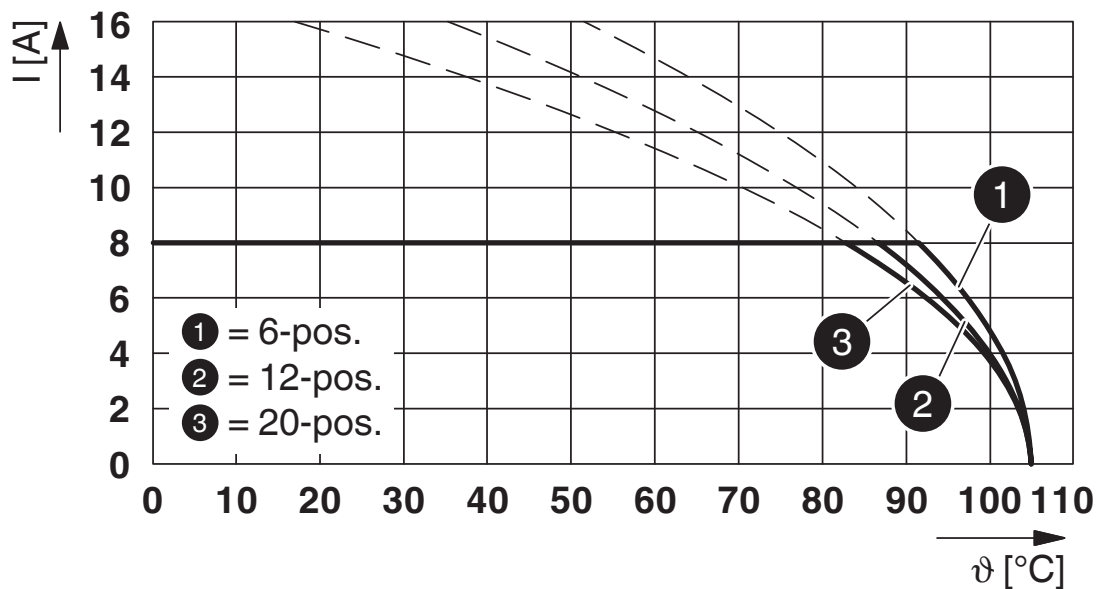

Type: DD32PC 2,2/...-5,08-XY with DD32H 2,2/...-H-5,08-XY

Diagram

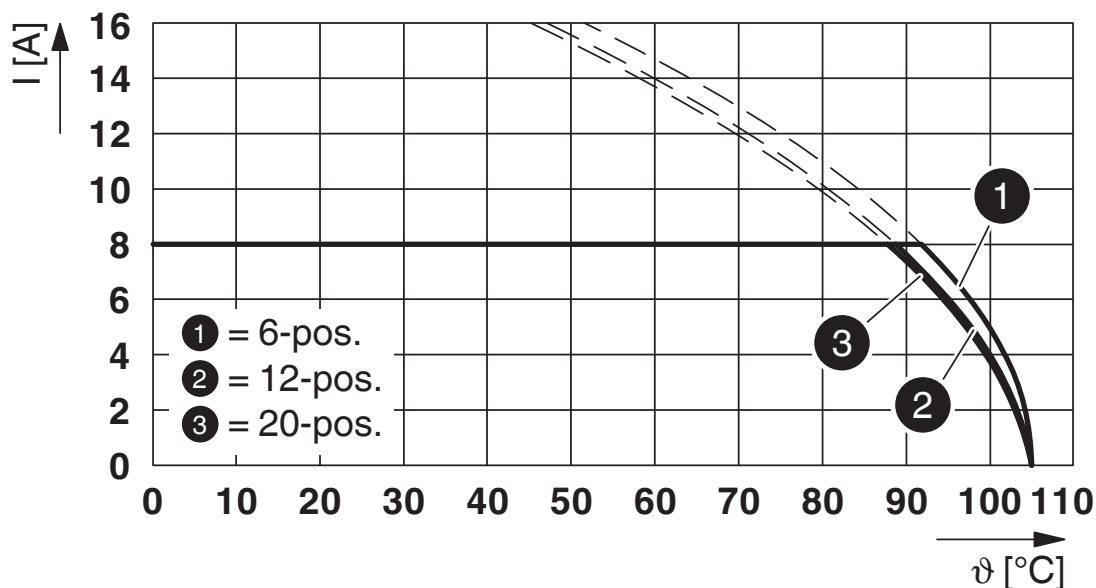

Type: DD32PC 2,2/...-5,08-XY with DD32H 2,2/...-V-5,08-XY

1378220

<https://www.phoenixcontact.com/us/products/1378220>

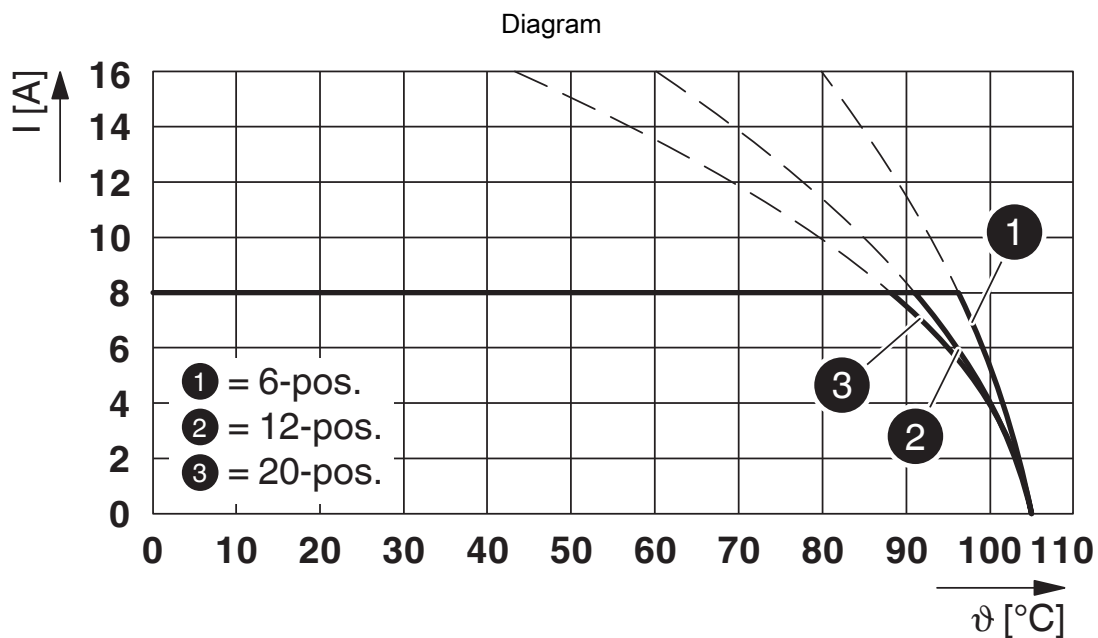

Type: DD32PC 2,2/...-5,08-XY with DD32H 2,2/...-PT-5,08-XY

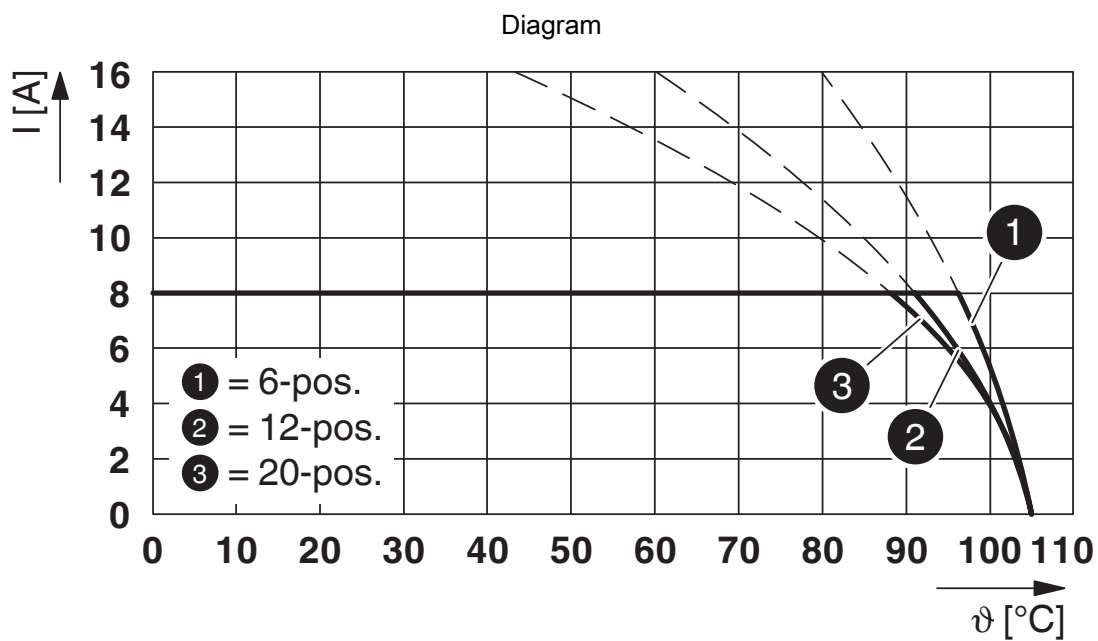

Type: DD32PC 2,2/...-5,08-XY with DD32H 2,2/...-FH-5,08-XY

DD32PC 2,2/12-5,08-XY - PCB connector



1378220

<https://www.phoenixcontact.com/us/products/1378220>

Approvals

To download certificates, visit the product detail page: <https://www.phoenixcontact.com/us/products/1378220>

 UL Recognized Approval ID: E118976-20240617				
	Nominal voltage U_N	Nominal current I_N	Cross section AWG	Cross section mm^2
keine				
	250 V	8.25 A	14	-

DD32PC 2,2/12-5,08-XY - PCB connector



1378220

<https://www.phoenixcontact.com/us/products/1378220>

Classifications

ECLASS

ECLASS-13.0	27460202
ECLASS-15.0	27460202

ETIM

ETIM 9.0	EC002638
----------	----------

DD32PC 2,2/12-5,08-XY - PCB connector



1378220

<https://www.phoenixcontact.com/us/products/1378220>

Environmental product compliance

EU RoHS

Fulfills EU RoHS substance requirements	Yes, No exemptions
---	--------------------

China RoHS

Environment friendly use period (EFUP)	EFUP-E
	No hazardous substances above the limits

EU REACH SVHC

REACH candidate substance (CAS No.)	No substance above 0.1 wt%
-------------------------------------	----------------------------

Phoenix Contact 2025 © - all rights reserved
<https://www.phoenixcontact.com>

Phoenix Contact USA
586 Fulling Mill Road
Middletown, PA 17057, United States
(+717) 944-1300
info@phoenixcon.com