

SAC-3P-M12MS/ 3,0-800 - Sensor/actuator cable



1456747

<https://www.phoenixcontact.com/us/products/1456747>

Please be informed that the data shown in this PDF document is generated from our online catalog. Please find the complete data in the user documentation. Our general terms of use for downloads are valid.

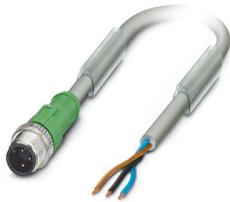

Sensor/actuator cable, 3-position, PUR halogen-free, resistant to welding sparks, highly flexible, gray RAL 7001, Plug straight M12, coding: A, on free cable end, cable length: 3 m, for robots and drag chains

Your advantages

- Easy and safe: 100 % electrically tested plug-in components
- Reliable solution for the body shop as cable is resistant to welding sparks

Commercial data

Item number	1456747
Packing unit	1 pc
Minimum order quantity	1 pc
Sales key	BF03
Product key	AF1CBA
GTIN	4046356593106
Weight per piece (including packing)	85.36 g
Weight per piece (excluding packing)	85.36 g
Customs tariff number	85444290
Country of origin	PL

SAC-3P-M12MS/ 3,0-800 - Sensor/actuator cable



1456747

<https://www.phoenixcontact.com/us/products/1456747>

Technical data

Product properties

Product type	Sensor/actuator cable
Application	Robots and drag chains
Number of positions	3
No. of cable outlets	1
Shielded	no
Coding	A

Insulation characteristics

Overvoltage category	II
Degree of pollution	3

Material specifications

Flammability rating according to UL 94	HB
Material of grip body	TPU, hardly inflammable, self-extinguishing
Contact material	CuSn
Contact surface material	Ni/Au
Contact carrier material	TPU GF
Material for screw connection	Zinc die-cast, nickel-plated

Electrical properties

Insulation resistance	$\geq 100 \text{ M}\Omega$
Nominal voltage U_N	250 V AC
	250 V DC
Nominal current I_N	4 A

Mechanical properties

Mechanical data

Insertion/withdrawal cycles	≥ 100
-----------------------------	------------

Signaling

Status display	no
Status display present	no

Connection data

Conductor connection

Tightening torque	0.4 Nm (M12 connector)
-------------------	------------------------

Connector

Connection 1

Type	Plug straight M12
------	-------------------

SAC-3P-M12MS/ 3,0-800 - Sensor/actuator cable



1456747

<https://www.phoenixcontact.com/us/products/1456747>

Number of positions	3
Coding type	A

Connection 2

Type	free cable end
------	----------------

Cable/line

Cable length	3 m
--------------	-----

Gray, highly flexible PUR [800]

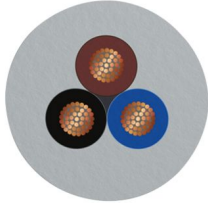
Dimensional drawing	
Note	Due to the extremely robust outer sheath, this cable should only be stripped in 5 cm increments.
Cable weight	28.3 kg/km
UL AWM Style	20549
Number of positions	3
Shielded	no
Cable type	Gray, highly flexible PUR [800]
Conductor structure signal line	42x 0.10 mm
AWG signal line	22
Conductor cross section	3x 0.34 mm ² (Signal line)
Wire diameter incl. insulation	1.3 mm ±0.05 mm (Signal line)
External cable diameter	4.50 mm ±0.2 mm
Outer sheath, material	PUR
External sheath, color	gray RAL 7001
Conductor material	Bare Cu litz wires
Material wire insulation	PP
Single wire, color	brown, blue, black
Overall twist	3 wires, twisted
Max. conductor resistance	approx. 53 Ω/km
Insulation resistance	≥ 20 MΩ*km
Nominal voltage, cable	300 V
Test voltage	2000 V
Minimum bending radius, fixed installation	4 x D
Minimum bending radius, flexible installation	7.5 x D
Smallest bending radius, fixed installation	18 mm
Smallest bending radius, movable installation	34 mm
Dynamic load capacity (bending)	Max. bending cycles: 10000000, Bending radius: 7,5 x D,

SAC-3P-M12MS/ 3,0-800 - Sensor/actuator cable



1456747

<https://www.phoenixcontact.com/us/products/1456747>

	Traversing path: 5 m, Traversing rate: 3.3 m/s, Acceleration: 5 m/s ²
	Max. bending cycles: 15000000, Bending radius: 50 mm, Traversing path: 0.9 m, Traversing rate: 5 m/s, Acceleration: 30 m/s ²
Dynamic load capacity (torsion)	Torsion: ±360 °/m, Torsion cycles: 1000000, Torsional frequency: 35 cycles/min.
Halogen-free	in accordance with DIN VDE 0472 part 815
Flame resistance	in accordance with UL 758/1581 FT2
Resistance to oil	in accordance with DIN EN 60811-2-1
Other resistance	Highly resistant to acids, alkaline solutions and solvents
	Silicone-free
Special properties	Cable jacket is welding spark-resistant, recyclable, matt, low-adhesion, abrasion-resistant, flame-retardant, and self-extinguishing
	Free from silicone and cadmium
	Free of substances which would hinder coating with paint or varnish
Ambient temperature (operation)	-40 °C ... 80 °C (cable, fixed installation)
	-25 °C ... 80 °C (Cable, flexible installation)

Environmental and real-life conditions

Ambient conditions

Degree of protection	IP65
	IP67
	IP68
Ambient temperature (operation) (male connector/female connector)	-25 °C ... 90 °C (Plug / socket)
Ambient temperature (operation) (Cable, fixed installation)	-40 °C ... 90 °C (cable, fixed installation)
Ambient temperature (operation) (Cable, flexible installation)	-30 °C ... 90 °C (Cable, flexible installation)
Ambient temperature (operation)	to 120 °C (for 3000 h)
	to 90 °C (in acc. with UL)

Standards and regulations

Standard designation	M12 connector
Standards/specifications	IEC 61076-2-101

SAC-3P-M12MS/ 3,0-800 - Sensor/actuator cable



1456747

<https://www.phoenixcontact.com/us/products/1456747>

Drawings

Dimensional drawing

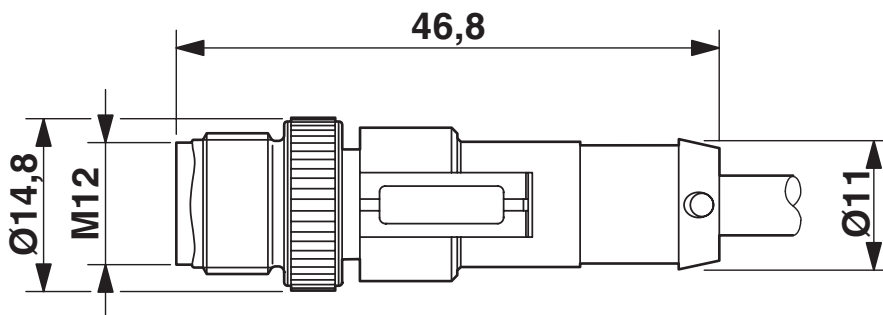

Plug, M12 x 1, straight, shielded

Schematic diagram

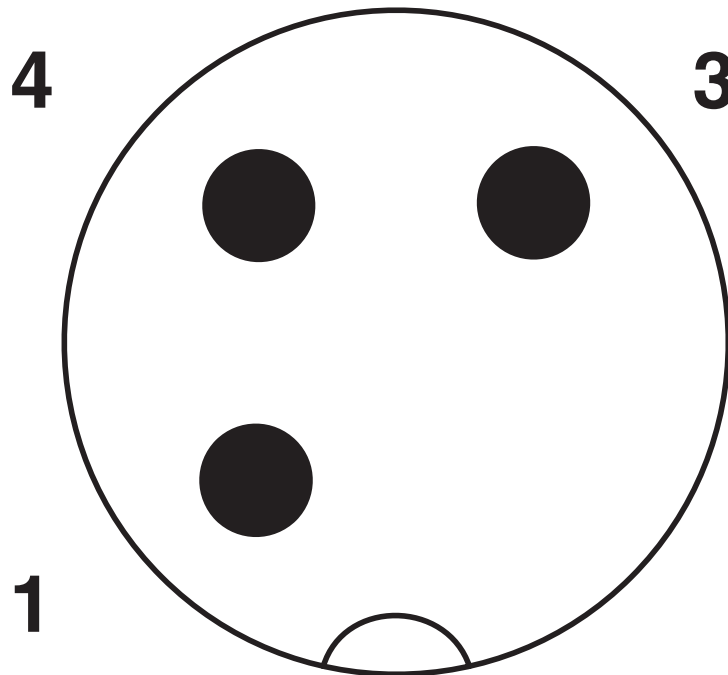

Pin assignment M12 plug, 3-pos., A-coded, view male side

SAC-3P-M12MS/ 3,0-800 - Sensor/actuator cable



1456747

<https://www.phoenixcontact.com/us/products/1456747>

Circuit diagram

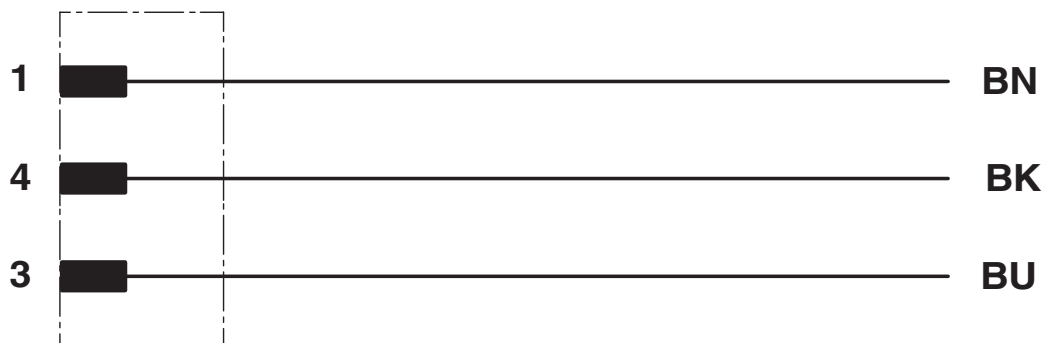

Contact assignment of the M12 plug

SAC-3P-M12MS/ 3,0-800 - Sensor/actuator cable





1456747

<https://www.phoenixcontact.com/us/products/1456747>

Approvals

To download certificates, visit the product detail page: <https://www.phoenixcontact.com/us/products/1456747>

 UL Listed Approval ID: FILE E 221474				
	Nominal voltage U_N	Nominal current I_N	Cross section AWG	Cross section mm^2
keine				
	300 V	4 A	-	-

 cUL Listed Approval ID: FILE E 221474				
	Nominal voltage U_N	Nominal current I_N	Cross section AWG	Cross section mm^2
keine				
	300 V	4 A	-	-

 EAC-RoHS Approval ID: RU D-DE.HB35.B.00387				
--	--	--	--	--

SAC-3P-M12MS/ 3,0-800 - Sensor/actuator cable



1456747

<https://www.phoenixcontact.com/us/products/1456747>

Classifications

ECLASS

ECLASS-13.0	27060311
ECLASS-15.0	27060311

ETIM

ETIM 9.0	EC001855
----------	----------

UNSPSC

UNSPSC 21.0	26121600
-------------	----------

SAC-3P-M12MS/ 3,0-800 - Sensor/actuator cable



1456747

<https://www.phoenixcontact.com/us/products/1456747>

Environmental product compliance

EU RoHS

Fulfills EU RoHS substance requirements	Yes, No exemptions
---	--------------------

China RoHS

Environment friendly use period (EFUP)	EFUP-E
	No hazardous substances above the limits

EU REACH SVHC

REACH candidate substance (CAS No.)	No substance above 0.1 wt%
-------------------------------------	----------------------------

EF3.0 Climate Change

CO2e kg	0.462 kg CO2e
---------	---------------

Phoenix Contact 2025 © - all rights reserved
<https://www.phoenixcontact.com>

Phoenix Contact USA
586 Fulling Mill Road
Middletown, PA 17057, United States
(+717) 944-1300
info@phoenixcon.com