

Product data sheet

Specifications



miniature plug in relay, Harmony Electromechanical Relays, 12A, 2CO, with LED, lockable test button, flat (faston type), 48V AC

RXM2AB2E7

Main

Range of product	Harmony Electromechanical Relays
Series name	RXM series
Product or component type	Plug-in relay
Relay type	Miniature relay
Contacts type and composition	2 C/O
status LED	With
Control type	Lockable test button
[Uc] control circuit voltage	48 V AC 50/60 Hz
[Ithe] conventional enclosed thermal current	12 A
Continuous output current	10 A

Complementary

[Uimp] rated impulse withstand voltage	4 kV during 1.2/50 μ s
[Ie] rated operational current	12 A at 28 V (DC) NO conforming to IEC 12 A at 250 V (AC) NO conforming to IEC 6 A at 28 V (DC) NC conforming to IEC 6 A at 250 V (AC) NC conforming to IEC 12 A at 28 V (DC) conforming to UL 12 A at 277 V (AC) conforming to UL
Minimum switching capacity	170 mW at 10 mA, 17 V
Electrical durability	100000 cycles for resistive load
Average coil consumption in VA	1.2 at 60 Hz
Rated operational voltage limits	38.4...52.8 V AC
[Ui] rated insulation voltage	250 V conforming to IEC 300 V conforming to CSA 300 V conforming to UL
Average consumption	1.2 VA at 60 Hz
Maximum switching voltage	250 V conforming to IEC
Drop-out voltage threshold	$\geq 0.15 U_c$
Load current	12 A at 250 V AC 12 A at 28 V DC
Operating time	20 ms
Maximum switching capacity	3000 VA/336 W
Average resistance	710 Ohm at 20 °C +/- 15 %
Mechanical durability	10000000 cycles

Safety reliability data	B10d = 100000
Operating rate	<= 1200 cycles/hour under load <= 18000 cycles/hour no-load
Utilisation coefficient	20 %
CAD overall height	79 mm
CAD overall depth	78.45 mm
reset time	20 ms
Dielectric strength	1300 V AC between contacts with micro disconnection 2000 V AC between coil and contact with basic insulation 2000 V AC between poles with basic insulation
Compatibility code	RXM
Protection category	RT I
Pollution degree	3
Operating position	Any position
Test levels	Level A group mounting
Device presentation	Complete product
Contacts material	AgNi
Shape of pin	Flat (faston type)
Product weight	0.037 kg

Environment

Ambient air temperature for operation	-40...55 °C
IP degree of protection	IP40 conforming to IEC 60529
Standards	UL 508 IEC 61810-1 CSA C22.2 No 14
Product certifications	UL Lloyd's CE CSA GOST IECEE CB Scheme
Ambient air temperature for storage	-40...85 °C
Vibration resistance	3 gn, amplitude = +/- 1 mm (f = 10...150 Hz)5 cycles in operation 5 gn, amplitude = +/- 1 mm (f = 10...150 Hz)5 cycles not operating
Shock resistance	10 gn for in operation 30 gn for not operating

Packing Units

Unit Type of Package 1	PCE
Number of Units in Package 1	1
Package 1 Height	4.7 cm
Package 1 Width	2.1 cm
Package 1 Length	2.7 cm
Package 1 Weight	37.0 g
Unit Type of Package 2	BB1
Number of Units in Package 2	10

Package 2 Height	3.0 cm
Package 2 Width	10.1 cm
Package 2 Length	12.5 cm
Package 2 Weight	399.0 g
Unit Type of Package 3	S02
Number of Units in Package 3	240
Package 3 Height	15.0 cm
Package 3 Width	30.0 cm
Package 3 Length	40.0 cm
Package 3 Weight	9.91 kg

Contractual warranty

Warranty	18 months
----------	-----------



Environmental Data

Schneider Electric aims to achieve Net Zero status by 2050 through supply chain partnerships, lower impact materials, and circularity via our ongoing “Use Better, Use Longer, Use Again” campaign to extend product lifetimes and recyclability.

[Environmental Data explained >](#)

[How we assess product sustainability >](#)

Environmental footprint

Total lifecycle Carbon footprint 20

Environmental Disclosure [Product Environmental Profile](#)

Use Better

Materials and Substances

Packaging made with recycled cardboard Yes

Packaging without single use plastic Yes

[EU RoHS Directive](#) Pro-active compliance (Product out of EU RoHS legal scope)

REACH Regulation [REACH Declaration](#)

California proposition 65 **WARNING:** This product can expose you to chemicals including: Nickel compounds, which is known to the State of California to cause cancer, and Di-isodecyl phthalate (DIDP), which is known to the State of California to cause birth defects or other reproductive harm. For more information go to www.P65Warnings.ca.gov

Use Again

Repack and remanufacture

End of life manual availability [End of Life Information](#)

Take-back No

Dimensions Drawings

Dimensions

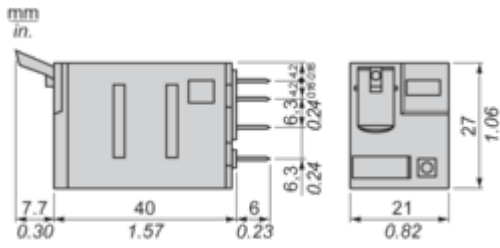

Pin Side View

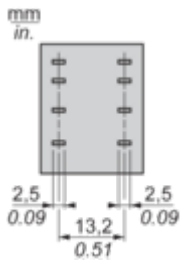

Connections and Schema

Wiring Diagram

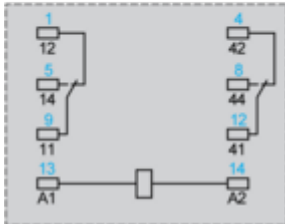
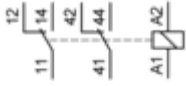

Symbols shown in blue correspond to Nema marking.

Performance Curves

Electrical Durability of Contacts

Durability (inductive load) = durability (resistive load) x reduction coefficient.

Resistive AC load

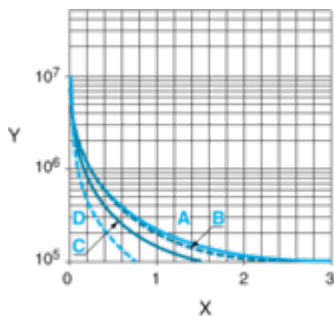

X Switching capacity (kVA)

Y Durability (Number of operating cycles)

A RXM2AB...

B RXM3AB...

C RXM4AB...

D RXM4GB...

Reduction coefficient for inductive AC load (depending on power factor $\cos \phi$)

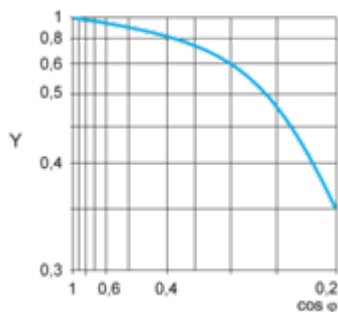

Y Reduction coefficient (A)

Maximum switching capacity on resistive DC load

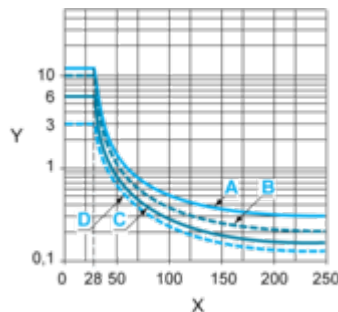

X Voltage DC

Y Current DC

A RXM2AB...

B RXM3AB...

C RXM4AB...

D RXM4GB...

Note : These are typical curves, actual durability depends on load, environment, duty cycle, etc.

For inductive load, to increase relay life cycles, please add a proper load protection circuit (eg: RC protection/Varistor/ free Wheeling diode -DC load only-).

For low level loads (below 10mA), we recommend to use RXM*GB series with bifurcated contacts relays instead.

AC Coil Voltage and Operating Temperature under continuous duty

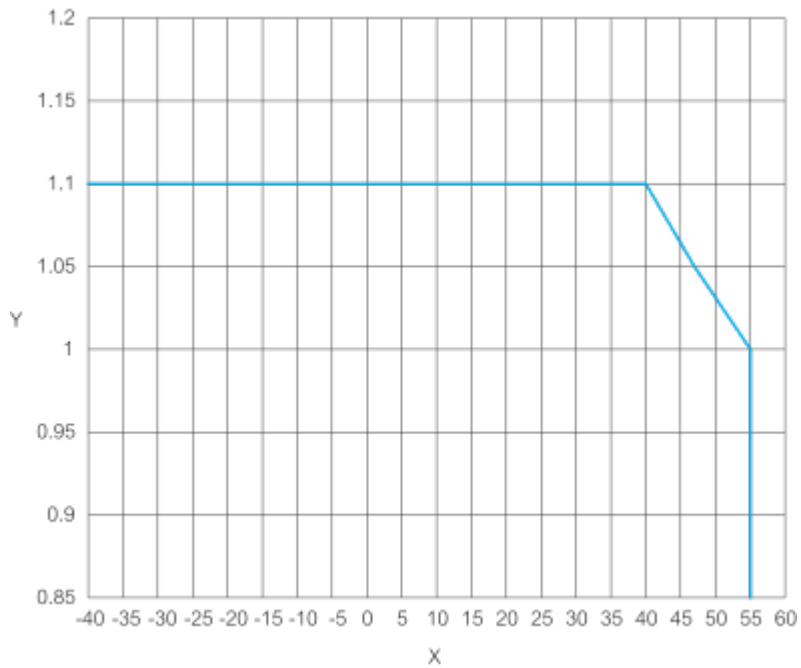

X : Operating temperature (°C)

Y : AC coil voltage (UC)

Technical Illustration

Dimensions

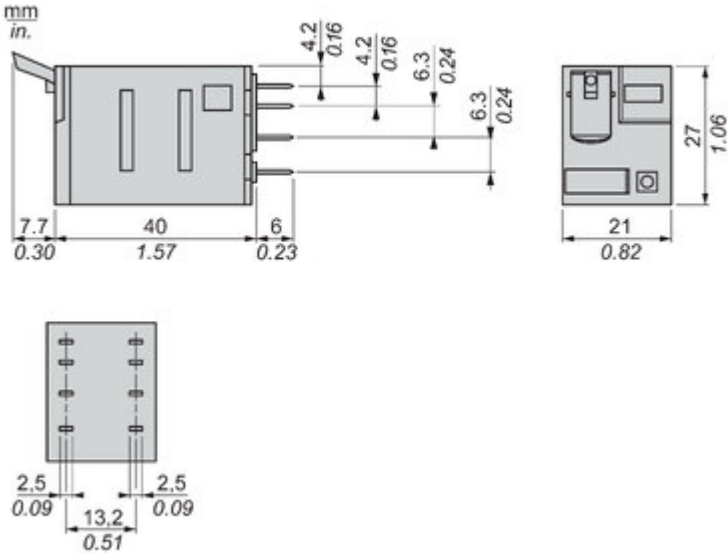

Image of product / Alternate images

Alternative



