

3.3 V/5 V ECL ÷2/4, ÷4/5/6 Clock Generation Chip

MC10EP139, MC100EP139

Description

The MC10/100EP139 is a low skew ÷2/4, ÷4/5/6 clock generation chip designed explicitly for low skew clock generation applications. The internal dividers are synchronous to each other, therefore, the common output edges are all precisely aligned.

The common enable (\overline{EN}) is synchronous so that the internal dividers will only be enabled/disabled when the internal clock is already in the LOW state. This avoids any chance of generating a runt clock pulse on the internal clock when the device is enabled/disabled as can happen with an asynchronous control. The internal enable flip-flop is clocked on the falling edge of the input clock, therefore, all associated specification limits are referenced to the negative edge of the clock input.

Upon start-up, the internal flip-flops will attain a random state; therefore the master reset (MR) input may require assertion to ensure system synchronization. Internal divider design ensures synchronization between the ÷2/4 and the ÷4/5/6 outputs within a device. All V_{CC} and V_{EE} pins must be externally connected to power supply to guarantee proper operation.

The V_{BB} Pin, an internally generated voltage supply, is available to this device only. For Single-Ended input conditions, the unused differential input is connected to V_{BB} as a switching reference voltage. V_{BB} may also rebias AC coupled inputs. When used, decouple V_{BB} and V_{CC} via a 0.01 μF capacitor and limit current sourcing or sinking to 0.5 mA. When not used, V_{BB} should be left open.

The 100 Series contains temperature compensation.

Features

- Maximum Frequency = > 1.0 GHz Typical
- 50 ps Output-to-Output Skew
- PECL Mode Operating Range:
 $V_{CC} = 3.0 V$ to $5.5 V$ with $V_{EE} = 0 V$
- NECL Mode Operating Range:
 $V_{CC} = 0 V$ with $V_{EE} = -3.0 V$ to $-5.5 V$
- Open Input Default State
- Safety Clamp on Inputs
- Synchronous Enable/Disable
- Master Reset for Synchronization of Multiple Chips
- V_{BB} Output
- These Devices are Pb-Free, Halogen Free and are RoHS Compliant

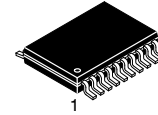

TSSOP-20 WB
DT SUFFIX
CASE 948E

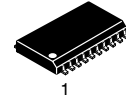

SOIC-20 WB
DW SUFFIX
CASE 751D

MARKING DIAGRAM

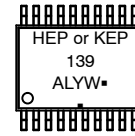

TSSOP-20 WB

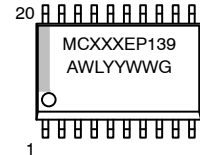

SOIC-20 WB

- HEP = MC10EP
- KEP = MC100EP
- XXX = 10 or 100
- A = Assembly Location
- L,WL = Wafer Lot
- Y,YY = Year
- W,WW = Work Week
- G or ■ = Pb-Free Package

(Note: Microdot may be in either location)
*For additional marking information, refer to Application Note [AND8002/D](#).

ORDERING INFORMATION

Device	Package	Shipping [†]
MC100EP139DTR2G	TSSOP-20 WB (Pb-Free)	2500 / Tape & Reel
MC100EP139DWG	TSSOP-20 WB (Pb-Free)	38 Units / Tube

DISCONTINUED (Note 1)

MC10EP139DTG	TSSOP-20 WB (Pb-Free)	75 Units / Tube
MC100EP139DTG	TSSOP-20 WB (Pb-Free)	75 Units / Tube

[†]For information on tape and reel specifications, including part orientation and tape sizes, please refer to our Tape and Reel Packaging Specifications Brochure, [BRD8011/D](#).

1. **DISCONTINUED:** This device is not recommended for new design. Please contact your **onsemi** representative for information. The most current information on this device may be available on www.onsemi.com.

MC10EP139, MC100EP139

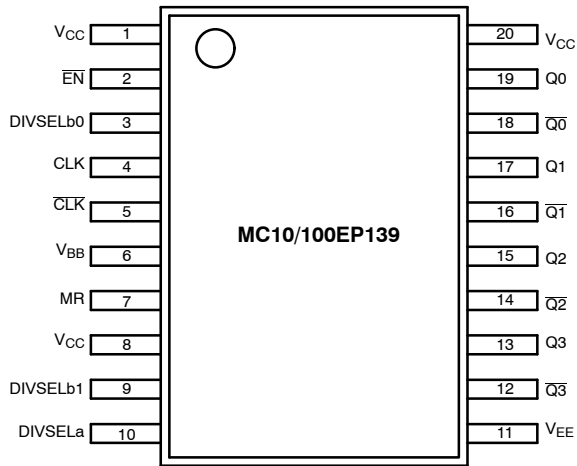

Warning: All V_{CC} and V_{EE} pins must be externally connected to a Power Supply to guarantee proper operation.

Figure 1. 20-Lead Pinout (Top View)

Table 1. PIN DESCRIPTION

PIN	FUNCTION
CLK*, $\overline{\text{CLK}}^*$	ECL Differential Clock Inputs
EN*	ECL Sync Enable
MR*	ECL Master Reset
V_{BB}	ECL Reference Output
Q0, Q1, $\overline{\text{Q0}}$, $\overline{\text{Q1}}$	ECL Differential $\div 2/4$ Outputs
Q2, Q3, $\overline{\text{Q2}}$, $\overline{\text{Q3}}$	ECL Differential $\div 4/5/6$ Outputs
DIVSELa*	ECL Frequency Select Input $\div 2/4$
DIVSELb0*	ECL Frequency Select Input $\div 4/5/6$
DIVSELb1*	ECL Frequency Select Input $\div 4/5/6$
V_{CC}	ECL Positive Supply
V_{EE}	ECL Negative Supply

*Pins will default low when left open.

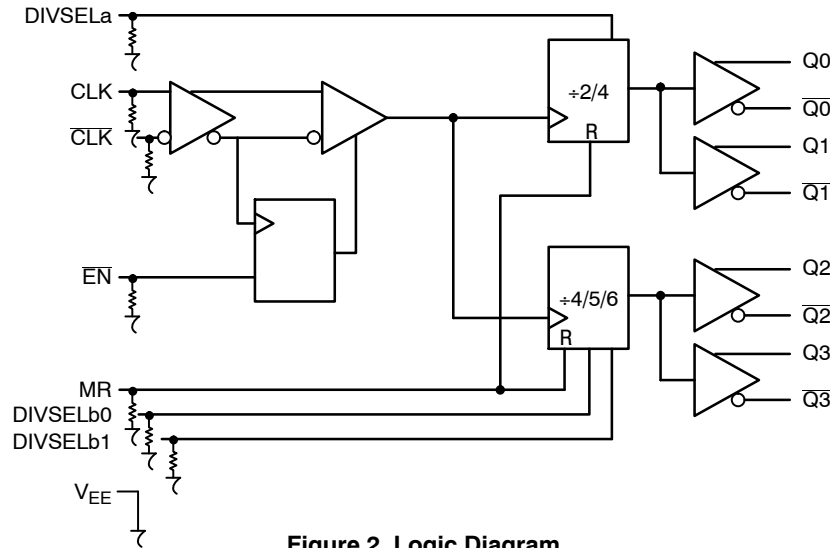

Figure 2. Logic Diagram

Table 2. FUNCTION TABLES

CLK	EN	MR	Function
Z	L	L	Divide
ZZ	H	L	Hold Q0:3
X	X	H	Reset Q0:3

Z = Low-to-High Transition
ZZ = High-to-Low Transition

DIVSELa	Q0:1 Outputs	
L	Divide by 2	
H	Divide by 4	
DIVSELb0	DIVSELb1	Q2:3 Outputs
L	L	Divide by 4
H	L	Divide by 6
L	H	Divide by 5
H	H	Divide by 5

MC10EP139, MC100EP139

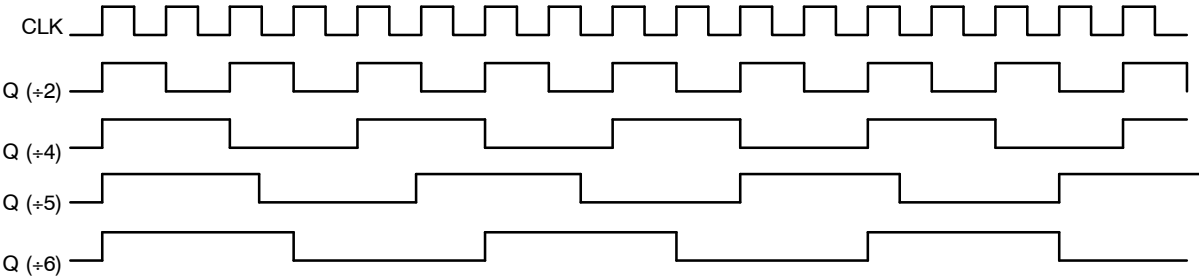

Figure 3. CLK and OUTPUT Timing Diagram

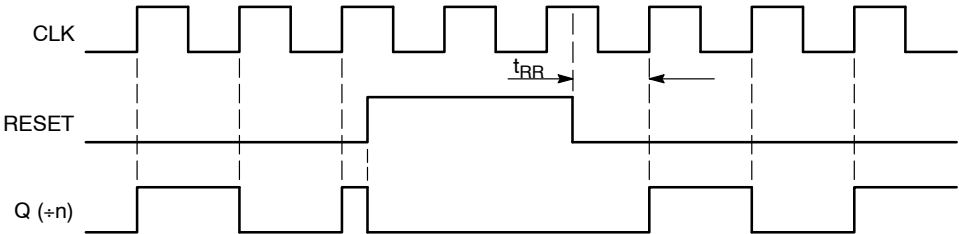

Figure 4. Timing Diagram

MC10EP139, MC100EP139

Table 3. ATTRIBUTES

Characteristics	Value
Internal Input Pulldown Resistor	75 kΩ
Internal Input Pullup Resistor	N/A
ESD Protection Human Body Model Machine Model Charged Device Model	> 2 kV > 100 V > 2 kV
Moisture Sensitivity, Indefinite Time Out of Drypack (Note 1)	Pb-Free Pkg
SOIC–20 WB TSSOP–20 W	Level 3 Level 1
Flammability Rating Oxygen Index: 28 to 34	UL 94 V–0 @ 0.125 in
Transistor Count	758 Devices
Meets or exceeds JEDEC Spec EIA/JESD78 IC Latchup Test	

1. For additional information, see Application Note [AND8003/D](#).

Table 4. MAXIMUM RATINGS

Symbol	Parameter	Condition 1	Condition 2	Rating	Unit
V _{CC}	PECL Mode Power Supply	V _{EE} = 0 V		6	V
V _{EE}	NECL Mode Power Supply	V _{CC} = 0 V		–6	V
V _I	PECL Mode Input Voltage NECL Mode Input Voltage	V _{EE} = 0 V V _{CC} = 0 V	V _I ≤ V _{CC} V _I ≥ V _{EE}	6 –6	V
I _{out}	Output Current	Continuous Surge		50 100	mA
I _{BB}	V _{BB} Sink/Source			±0.5	mA
T _A	Operating Temperature Range			–40 to +85	°C
T _{stg}	Storage Temperature Range			–65 to +150	°C
θ _{JA}	Thermal Resistance (Junction-to-Ambient)	0 lfpm 500 lfpm	TSSOP–20 WB TSSOP–20 WB	140 100	°C/W
θ _{JC}	Thermal Resistance (Junction-to-Case)	Standard Board	TSSOP–20 WB	23 to 41	°C/W
θ _{JA}	Thermal Resistance (Junction-to-Ambient)	0 lfpm 500 lfpm	SOIC–20 WB SOIC–20 WB	90 60	°C/W
θ _{JC}	Thermal Resistance (Junction-to-Case)	Standard Board	SOIC–20 WB	33 to 35	°C/W
T _{sol}	Wave Solder (Pb-Free)	< 2 to 3 sec @ 260°C		265	°C

Stresses exceeding those listed in the Maximum Ratings table may damage the device. If any of these limits are exceeded, device functionality should not be assumed, damage may occur and reliability may be affected.

MC10EP139, MC100EP139

Table 5. 10EP DC CHARACTERISTICS, PECL ($V_{CC} = 3.3\text{ V}$, $V_{EE} = 0\text{ V}$ (Note 1))

Symbol	Characteristic	-40°C			25°C			85°C			Unit
		Min	Typ	Max	Min	Typ	Max	Min	Typ	Max	
I_{EE}	Power Supply Current	65	82	105	65	83	105	65	84	105	mA
V_{OH}	Output HIGH Voltage (Note 2)	2165	2290	2415	2230	2355	2480	2290	2415	2540	mV
V_{OL}	Output LOW Voltage (Note 2)	1365	1490	1615	1430	1555	1680	1490	1615	1740	mV
V_{IH}	Input HIGH Voltage (Single-Ended)	2090		2415	2155		2480	2215		2540	mV
V_{IL}	Input LOW Voltage (Single-Ended)	1365		1690	1460		1755	1490		1815	mV
V_{BB}	Output Voltage Reference	1790	1890	1990	1855	1955	2055	1915	2015	2115	mV
V_{IHCMR}	Input HIGH Voltage Common Mode Range (Differential Configuration) (Note 3)	2.0		3.3	2.0		3.3	2.0		3.3	V
I_{IH}	Input HIGH Current			150			150			150	μA
I_{IL}	Input LOW Current	0.5			0.5			0.5			μA

NOTE: Device will meet the specifications after thermal equilibrium has been established when mounted in a test socket or printed circuit board with maintained transverse airflow greater than 500 lfm.

1. Input and output parameters vary 1:1 with V_{CC} . V_{EE} can vary +0.3 V to -2.2 V.
2. All loading with 50 Ω to $V_{CC} - 2.0\text{ V}$ (see Figure 9).
3. V_{IHCMR} min varies 1:1 with V_{EE} . V_{IHCMR} max varies 1:1 with V_{CC} . The V_{IHCMR} range is referenced to the most positive side of the differential input signal.

Table 6. 10EP DC CHARACTERISTICS, PECL ($V_{CC} = 5.0\text{ V}$, $V_{EE} = 0\text{ V}$ (Note 1))

Symbol	Characteristic	-40°C			25°C			85°C			Unit
		Min	Typ	Max	Min	Typ	Max	Min	Typ	Max	
I_{EE}	Power Supply Current	65	82	105	65	83	105	65	84	105	mA
V_{OH}	Output HIGH Voltage (Note 2)	3865	3990	4115	3930	4055	4180	3990	4115	4240	mV
V_{OL}	Output LOW Voltage (Note 2)	3065	3190	3315	3130	3255	3380	3190	3315	3440	mV
V_{IH}	Input HIGH Voltage (Single-Ended)	3790		4115	3855		4180	3915		4240	mV
V_{IL}	Input LOW Voltage (Single-Ended)	3065		3390	3130		3455	3190		3515	mV
V_{BB}	Output Voltage Reference	3490	3590	3690	3555	3655	3755	3615	3715	3815	mV
V_{IHCMR}	Input HIGH Voltage Common Mode Range (Differential Configuration) (Note 3)	2.0		5.0	2.0		5.0	2.0		5.0	V
I_{IH}	Input HIGH Current			150			150			150	μA
I_{IL}	Input LOW Current	0.5			0.5			0.5			μA

NOTE: Device will meet the specifications after thermal equilibrium has been established when mounted in a test socket or printed circuit board with maintained transverse airflow greater than 500 lfm.

1. Input and output parameters vary 1:1 with V_{CC} . V_{EE} can vary +2.0 V to -0.5 V.
2. All loading with 50 Ω to $V_{CC} - 2.0\text{ V}$ (see Figure 9).
3. V_{IHCMR} min varies 1:1 with V_{EE} . V_{IHCMR} max varies 1:1 with V_{CC} . The V_{IHCMR} range is referenced to the most positive side of the differential input signal.

MC10EP139, MC100EP139

Table 7. 10EP DC CHARACTERISTICS, NECL ($V_{CC} = 0\text{ V}$, $V_{EE} = -5.5\text{ V}$ to -3.0 V (Note 1))

Symbol	Characteristic	-40°C			25°C			85°C			Unit
		Min	Typ	Max	Min	Typ	Max	Min	Typ	Max	
I_{EE}	Power Supply Current	65	82	105	65	83	105	65	84	105	mA
V_{OH}	Output HIGH Voltage (Note 2)	-1135	-1010	-885	-1070	-945	-820	-1010	-885	-760	mV
V_{OL}	Output LOW Voltage (Note 2)	-1935	-1810	-1685	-1870	-1745	-1620	-1810	-1685	-1560	mV
V_{IH}	Input HIGH Voltage (Single-Ended)	-1210		-885	-1145		-820	-1085		-760	mV
V_{IL}	Input LOW Voltage (Single-Ended)	-1935		-1610	-1870		-1545	-1810		-1485	mV
V_{BB}	Output Voltage Reference	-1510	-1410	-1310	-1445	-1345	-1245	-1385	-1285	-1185	mV
V_{IHCMR}	Input HIGH Voltage Common Mode Range (Differential Configuration) (Note 3)	$V_{EE}+2.0$		0.0	$V_{EE}+2.0$		0.0	$V_{EE}+2.0$		0.0	V
I_{IH}	Input HIGH Current			150			150			150	μA
I_{IL}	Input LOW Current	0.5			0.5			0.5			μA

NOTE: Device will meet the specifications after thermal equilibrium has been established when mounted in a test socket or printed circuit board with maintained transverse airflow greater than 500 lfm.

1. Input and output parameters vary 1:1 with V_{CC} .
2. All loading with $50\ \Omega$ to $V_{CC} - 2.0\text{ V}$ (see Figure 9).
3. V_{IHCMR} min varies 1:1 with V_{EE} , V_{IHCMR} max varies 1:1 with V_{CC} . The V_{IHCMR} range is referenced to the most positive side of the differential input signal.

Table 8. 100EP DC CHARACTERISTICS, PECL ($V_{CC} = 3.3\text{ V}$, $V_{EE} = 0\text{ V}$ (Note 1))

Symbol	Characteristic	-40°C			25°C			85°C			Unit
		Min	Typ	Max	Min	Typ	Max	Min	Typ	Max	
I_{EE}	Power Supply Current	70	83	100	70	87	105	75	90	110	mA
V_{OH}	Output HIGH Voltage (Note 2)	2155	2280	2405	2155	2280	2405	2155	2280	2405	mV
V_{OL}	Output LOW Voltage (Note 2)	1305	1480	1605	1305	1480	1605	1305	1480	1605	mV
V_{IH}	Input HIGH Voltage (Single-Ended)	2075		2420	2075		2420	2075		2420	mV
V_{IL}	Input LOW Voltage (Single-Ended)	1305		1675	1305		1675	1305		1675	mV
V_{BB}	Output Voltage Reference	1725	1825	1925	1725	1825	1925	1725	1825	1925	mV
V_{IHCMR}	Input HIGH Voltage Common Mode Range (Differential Configuration) (Note 3)	2.0		3.3	2.0		3.3	2.0		3.3	V
I_{IH}	Input HIGH Current			150			150			150	μA
I_{IL}	Input LOW Current	0.5			0.5			0.5			μA

NOTE: Device will meet the specifications after thermal equilibrium has been established when mounted in a test socket or printed circuit board with maintained transverse airflow greater than 500 lfm.

1. Input and output parameters vary 1:1 with V_{CC} . V_{EE} can vary $+0.3\text{ V}$ to -2.2 V .
2. All loading with $50\ \Omega$ to $V_{CC} - 2.0\text{ V}$ (see Figure 9).
3. V_{IHCMR} min varies 1:1 with V_{EE} , V_{IHCMR} max varies 1:1 with V_{CC} . The V_{IHCMR} range is referenced to the most positive side of the differential input signal.

MC10EP139, MC100EP139

Table 9. 100EP DC CHARACTERISTICS, PECL ($V_{CC} = 5.0\text{ V}$, $V_{EE} = 0\text{ V}$ (Note 1))

Symbol	Characteristic	-40°C			25°C			85°C			Unit
		Min	Typ	Max	Min	Typ	Max	Min	Typ	Max	
I_{EE}	Power Supply Current	70	85	100	70	90	105	75	95	110	mA
V_{OH}	Output HIGH Voltage (Note 2)	3855	3980	4105	3855	3980	4105	3855	3980	4105	mV
V_{OL}	Output LOW Voltage (Note 2)	3005	3180	3305	3005	3180	3305	3005	3180	3305	mV
V_{IH}	Input HIGH Voltage (Single-Ended)	3775		4120	3775		4120	3775		4120	mV
V_{IL}	Input LOW Voltage (Single-Ended)	3005		3375	3005		3375	3005		3375	mV
V_{BB}	Output Voltage Reference	3425	3525	3625	3425	3525	3625	3425	3525	3625	mV
V_{IHCMR}	Input HIGH Voltage Common Mode Range (Differential Configuration) (Note 3)	2.0		5.0	2.0		5.0	2.0		5.0	V
I_{IH}	Input HIGH Current			150			150			150	μA
I_{IL}	Input LOW Current	0.5			0.5			0.5			μA

NOTE: Device will meet the specifications after thermal equilibrium has been established when mounted in a test socket or printed circuit board with maintained transverse airflow greater than 500 lpm.

1. Input and output parameters vary 1:1 with V_{CC} . V_{EE} can vary +2.0 V to -0.5 V.
2. All loading with 50 Ω to $V_{CC} - 2.0\text{ V}$ (see Figure 9).
3. V_{IHCMR} min varies 1:1 with V_{EE} . V_{IHCMR} max varies 1:1 with V_{CC} . The V_{IHCMR} range is referenced to the most positive side of the differential input signal.

Table 10. 100EP DC CHARACTERISTICS, NECL ($V_{CC} = 0\text{ V}$, $V_{EE} = -5.5\text{ V}$ to -3.0 V (Note 1))

Symbol	Characteristic	-40°C			25°C			85°C			Unit
		Min	Typ	Max	Min	Typ	Max	Min	Typ	Max	
I_{EE}	Power Supply Current	70	85	100	70	90	105	75	95	110	mA
V_{OH}	Output HIGH Voltage (Note 2)	-1145	-1020	-895	-1145	-1020	-895	-1145	-1020	-895	mV
V_{OL}	Output LOW Voltage (Note 2)	-1995	-1820	-1695	-1995	-1820	-1695	-1995	-1820	-1695	mV
V_{IH}	Input HIGH Voltage (Single-Ended)	-1225		-880	-1225		-880	-1225		-880	mV
V_{IL}	Input LOW Voltage (Single-Ended)	-1995		-1625	-1995		-1625	-1995		-1625	mV
V_{BB}	Output Voltage Reference	-1575	-1475	-1375	-1575	-1475	-1375	-1575	-1475	-1375	mV
V_{IHCMR}	Input HIGH Voltage Common Mode Range (Differential Configuration) (Note 3)	$V_{EE}+2.0$		0.0	$V_{EE}+2.0$		0.0	$V_{EE}+2.0$		0.0	V
I_{IH}	Input HIGH Current			150			150			150	μA
I_{IL}	Input LOW Current	0.5			0.5			0.5			μA

NOTE: Device will meet the specifications after thermal equilibrium has been established when mounted in a test socket or printed circuit board with maintained transverse airflow greater than 500 lpm.

1. Input and output parameters vary 1:1 with V_{CC} .
2. All loading with 50 Ω to $V_{CC} - 2.0\text{ V}$ (see Figure 9).
3. V_{IHCMR} min varies 1:1 with V_{EE} . V_{IHCMR} max varies 1:1 with V_{CC} . The V_{IHCMR} range is referenced to the most positive side of the differential input signal.

MC10EP139, MC100EP139

Table 11. AC CHARACTERISTICS ($V_{CC} = 0\text{ V}$; $V_{EE} = -3.0\text{ V}$ to -5.5 V or $V_{CC} = 3.0\text{ V}$ to 5.5 V ; $V_{EE} = 0\text{ V}$ (Note 1))

Symbol	Characteristic	-40°C			25°C			85°C			Unit
		Min	Typ	Max	Min	Typ	Max	Min	Typ	Max	
f_{max}	Maximum Frequency (See Figures 5, 6, 7 and 8 F_{max} /JITTER)		> 1			> 1			> 1		GHz
t_{PLH} , t_{PHL}	Propagation Delay CLK, Q (Diff) MR, Q	550 700	700 800	800 900	600 700	750 850	900 1000	675 800	825 950	975 1100	ps
t_{RR}	Reset Recovery	200	100		200	100		200	100		ps
t_s	Setup Time EN, CLK DIVSEL, CLK	200 400	120 180		200 400	120 180		200 400	120 180		ps
t_h	Hold Time $\overline{\text{CLK}}$, EN CLK, DIVSEL	100 200	50 140		100 200	50 140		100 200	50 140		ps
t_{PW}	Minimum Pulse Width MR	550	450		550	450		550	450		ps
t_{SKEW}	Within Device Skew Device-to-Device Skew (Note 2)		50 200	100 300		50 200	100 300		50 200	100 300	ps
t_{JITTER}	Random Clock Jitter (RMS) (See Figures 5, 6, 7 and 8 F_{max} /JITTER)		0.2	< 1.0		0.2	< 1.0		0.2	< 1.5	ps
V_{PP}	Input Voltage Swing (Differential Configuration)	150	800	1200	150	800	1200	150	800	1200	mV
t_r t_f	Output Rise/Fall Times Q, \overline{Q} (20%–80%)	110	180	250	125	190	275	150	215	300	ps

NOTE: Device will meet the specifications after thermal equilibrium has been established when mounted in a test socket or printed circuit board with maintained transverse airflow greater than 500 lpm.

1. Measured using a 750 mV source, 50% duty cycle clock source. All loading with $50\ \Omega$ to $V_{CC} - 2.0\text{ V}$ (see Figure 9).
2. Skew is measured between outputs under identical transitions. Duty cycle skew is defined only for differential operation when the delays are measured from the cross point of the inputs to the cross point of the outputs.

MC10EP139, MC100EP139

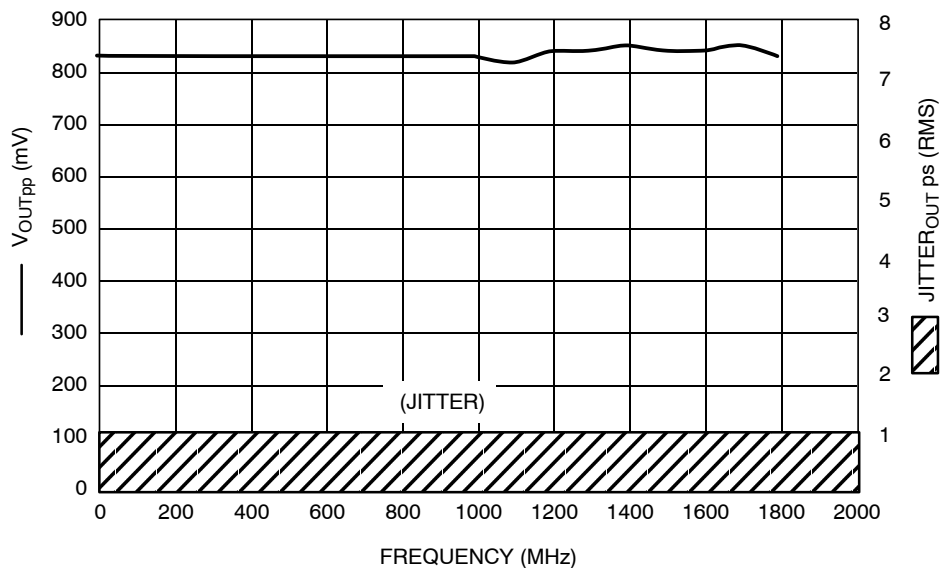

Figure 5. ÷ 2, F_{max}/Jitter

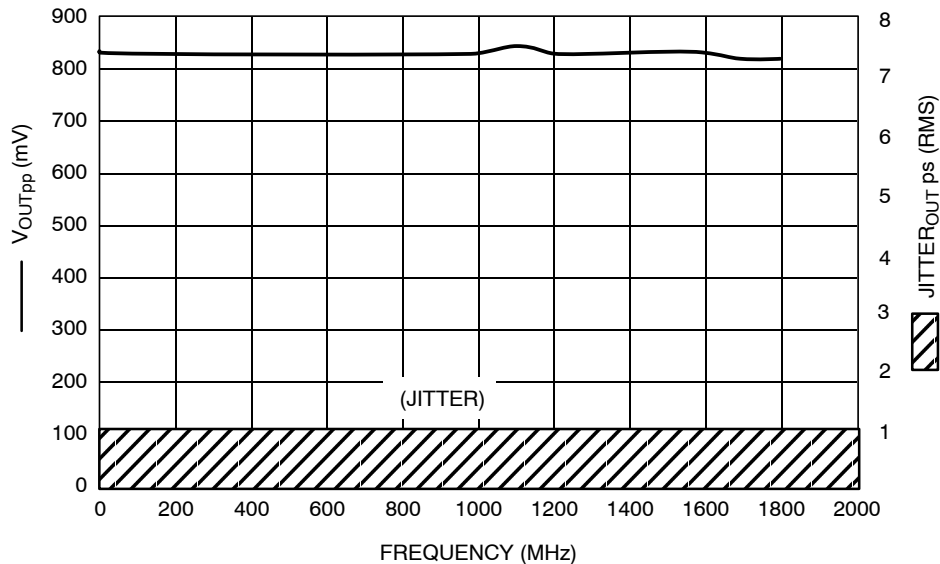

Figure 6. ÷ 5, F_{max}/Jitter

MC10EP139, MC100EP139

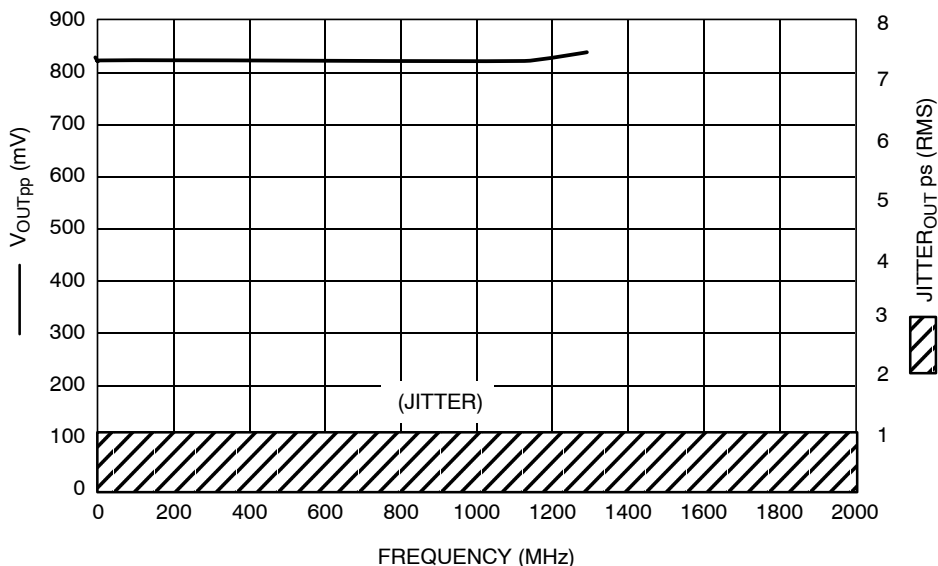

Figure 7. $\div 4$, $F_{max}/Jitter$

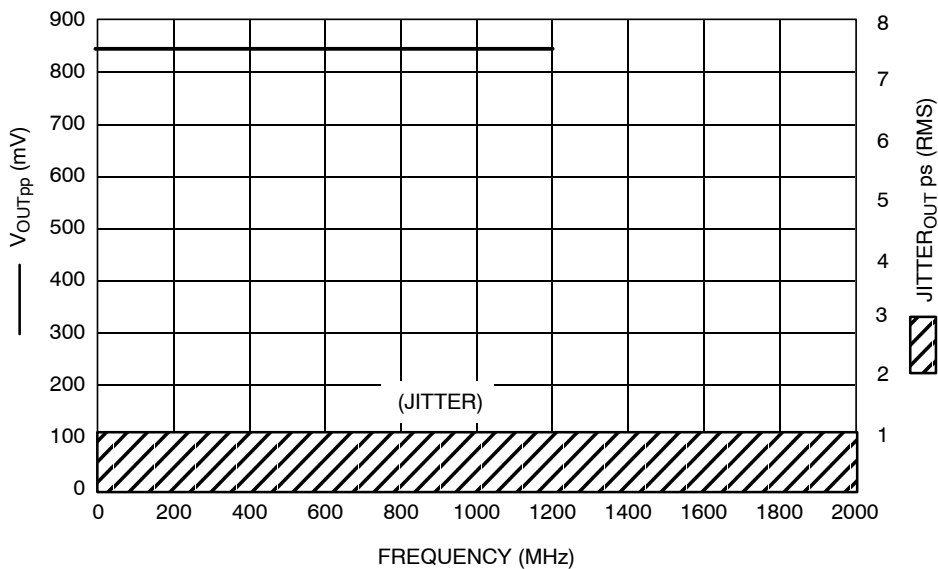

Figure 8. $\div 6$, $F_{max}/Jitter$

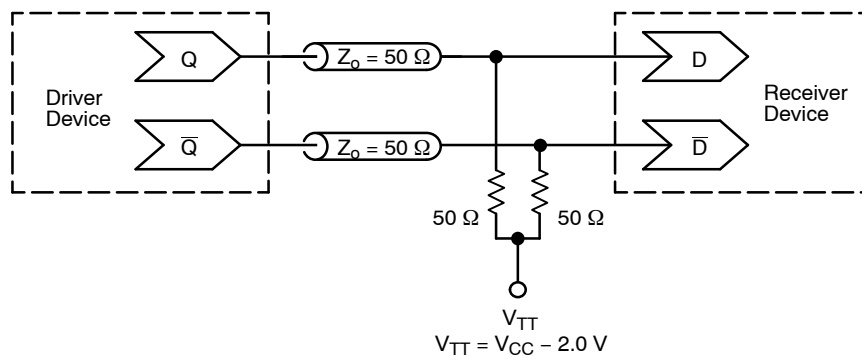
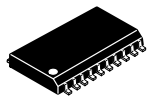

Figure 9. Typical Termination for Output Driver and Device Evaluation (See Application Note [AND8020/D](#) – Termination of ECL Logic Devices)

Resource Reference of Application Notes

- AN1405/D** – ECL Clock Distribution Techniques
- AN1406/D** – Designing with PECL (ECL at +5.0 V)
- AN1503/D** – ECLinPS™ I/O SPiCE Modeling Kit
- AN1504/D** – Metastability and the ECLinPS Family
- AN1568/D** – Interfacing Between LVDS and ECL
- AN1672/D** – The ECL Translator Guide
- AND8001/D** – Odd Number Counters Design
- AND8002/D** – Marking and Date Codes
- AND8020/D** – Termination of ECL Logic Devices
- AND8066/D** – Interfacing with ECLinPS
- AND8090/D** – AC Characteristics of ECL Devices

ECLinPS is registered trademark of Semiconductor Components Industries, LLC dba “**onsemi**” or its affiliates and/or subsidiaries in the United States and/or other countries.



SCALE 1:1

SOIC-20 WB
CASE 751D-05
ISSUE H

DATE 22 APR 2015

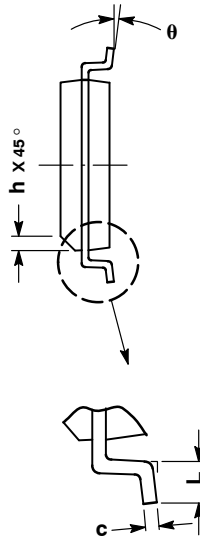
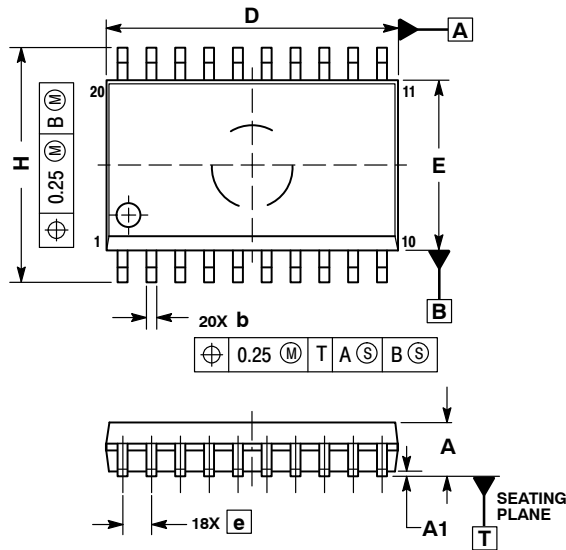

NOTES:

1. DIMENSIONS ARE IN MILLIMETERS.
2. INTERPRET DIMENSIONS AND TOLERANCES PER ASME Y14.5M, 1994.
3. DIMENSIONS D AND E DO NOT INCLUDE MOLD PROTRUSION.
4. MAXIMUM MOLD PROTRUSION 0.15 PER SIDE.
5. DIMENSION B DOES NOT INCLUDE DAMBAR PROTRUSION. ALLOWABLE PROTRUSION SHALL BE 0.13 TOTAL IN EXCESS OF B DIMENSION AT MAXIMUM MATERIAL CONDITION.

DIM	MILLIMETERS	
	MIN	MAX
A	2.35	2.65
A1	0.10	0.25
b	0.35	0.49
c	0.23	0.32
D	12.65	12.95
E	7.40	7.60
e	1.27 BSC	
H	10.05	10.55
h	0.25	0.75
L	0.50	0.90
θ	0°	7°

RECOMMENDED
SOLDERING FOOTPRINT*

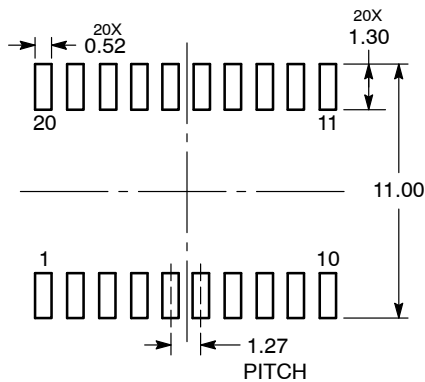

DIMENSIONS: MILLIMETERS

*For additional information on our Pb-Free strategy and soldering details, please download the onsemi Soldering and Mounting Techniques Reference Manual, SOLDERRM/D.

GENERIC
MARKING DIAGRAM*

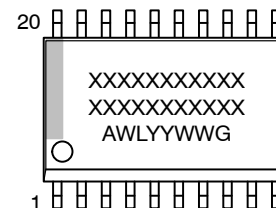

- XXXXXX = Specific Device Code
- A = Assembly Location
- WL = Wafer Lot
- YY = Year
- WW = Work Week
- G = Pb-Free Package

*This information is generic. Please refer to device data sheet for actual part marking. Pb-Free indicator, "G" or microdot "▪", may or may not be present. Some products may not follow the Generic Marking.

DOCUMENT NUMBER:	98ASB42343B	Electronic versions are uncontrolled except when accessed directly from the Document Repository. Printed versions are uncontrolled except when stamped "CONTROLLED COPY" in red.
DESCRIPTION:	SOIC-20 WB	PAGE 1 OF 1

onsemi and onsemi are trademarks of Semiconductor Components Industries, LLC dba onsemi or its subsidiaries in the United States and/or other countries. onsemi reserves the right to make changes without further notice to any products herein. onsemi makes no warranty, representation or guarantee regarding the suitability of its products for any particular purpose, nor does onsemi assume any liability arising out of the application or use of any product or circuit, and specifically disclaims any and all liability, including without limitation special, consequential or incidental damages. onsemi does not convey any license under its patent rights nor the rights of others.

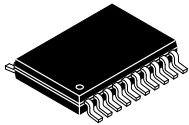

TSSOP-20 WB
CASE 948E
ISSUE D

DATE 17 FEB 2016

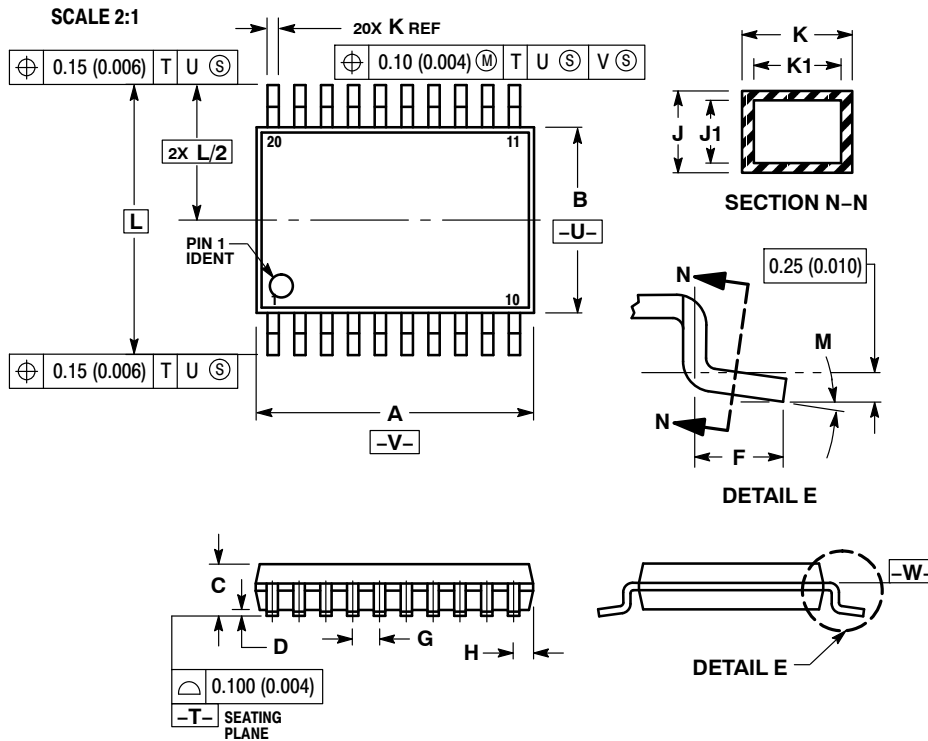

NOTES:

1. DIMENSIONING AND TOLERANCING PER ANSI Y14.5M, 1982.
2. CONTROLLING DIMENSION: MILLIMETER.
3. DIMENSION A DOES NOT INCLUDE MOLD FLASH, PROTRUSIONS OR GATE BURRS. MOLD FLASH OR GATE BURRS SHALL NOT EXCEED 0.15 (0.006) PER SIDE.
4. DIMENSION B DOES NOT INCLUDE INTERLEAD FLASH OR PROTRUSION. INTERLEAD FLASH OR PROTRUSION SHALL NOT EXCEED 0.25 (0.010) PER SIDE.
5. DIMENSION K DOES NOT INCLUDE DAMBAR PROTRUSION. ALLOWABLE DAMBAR PROTRUSION SHALL BE 0.08 (0.003) TOTAL IN EXCESS OF THE K DIMENSION AT MAXIMUM MATERIAL CONDITION.
6. TERMINAL NUMBERS ARE SHOWN FOR REFERENCE ONLY.
7. DIMENSION A AND B ARE TO BE DETERMINED AT DATUM PLANE -W-.

DIM	MILLIMETERS		INCHES	
	MIN	MAX	MIN	MAX
A	6.40	6.60	0.252	0.260
B	4.30	4.50	0.169	0.177
C	---	1.20	---	0.047
D	0.05	0.15	0.002	0.006
F	0.50	0.75	0.020	0.030
G	0.65 BSC		0.026 BSC	
H	0.27	0.37	0.011	0.015
J	0.09	0.20	0.004	0.008
J1	0.09	0.16	0.004	0.006
K	0.19	0.30	0.007	0.012
K1	0.19	0.25	0.007	0.010
L	6.40 BSC		0.252 BSC	
M	0°	8°	0°	8°

RECOMMENDED
SOLDERING FOOTPRINT*

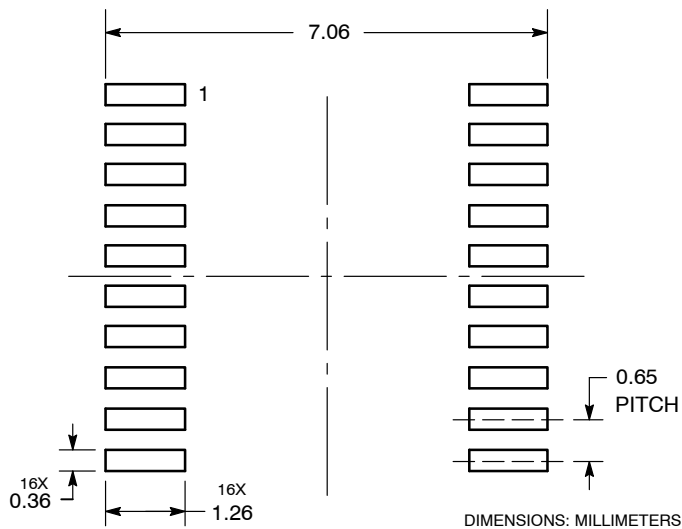

*For additional information on our Pb-Free strategy and soldering details, please download the onsemi Soldering and Mounting Techniques Reference Manual, SOLDERRM/D.

GENERIC
MARKING DIAGRAM*

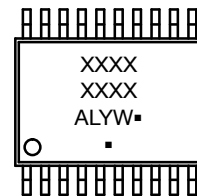

- A = Assembly Location
- L = Wafer Lot
- Y = Year
- W = Work Week
- = Pb-Free Package

(Note: Microdot may be in either location)

*This information is generic. Please refer to device data sheet for actual part marking. Pb-Free indicator, "G" or microdot "▪", may or may not be present. Some products may not follow the Generic Marking.

DOCUMENT NUMBER:	98ASH70169A	Electronic versions are uncontrolled except when accessed directly from the Document Repository. Printed versions are uncontrolled except when stamped "CONTROLLED COPY" in red.
DESCRIPTION:	TSSOP-20 WB	PAGE 1 OF 1

onsemi and onsemi are trademarks of Semiconductor Components Industries, LLC dba onsemi or its subsidiaries in the United States and/or other countries. onsemi reserves the right to make changes without further notice to any products herein. onsemi makes no warranty, representation or guarantee regarding the suitability of its products for any particular purpose, nor does onsemi assume any liability arising out of the application or use of any product or circuit, and specifically disclaims any and all liability, including without limitation special, consequential or incidental damages. onsemi does not convey any license under its patent rights nor the rights of others.

onsemi, **Onsemi**, and other names, marks, and brands are registered and/or common law trademarks of Semiconductor Components Industries, LLC dba "**onsemi**" or its affiliates and/or subsidiaries in the United States and/or other countries. **onsemi** owns the rights to a number of patents, trademarks, copyrights, trade secrets, and other intellectual property. A listing of **onsemi**'s product/patent coverage may be accessed at www.onsemi.com/site/pdf/Patent-Marking.pdf. **onsemi** reserves the right to make changes at any time to any products or information herein, without notice. The information herein is provided "as-is" and **onsemi** makes no warranty, representation or guarantee regarding the accuracy of the information, product features, availability, functionality, or suitability of its products for any particular purpose, nor does **onsemi** assume any liability arising out of the application or use of any product or circuit, and specifically disclaims any and all liability, including without limitation special, consequential or incidental damages. Buyer is responsible for its products and applications using **onsemi** products, including compliance with all laws, regulations and safety requirements or standards, regardless of any support or applications information provided by **onsemi**. "Typical" parameters which may be provided in **onsemi** data sheets and/or specifications can and do vary in different applications and actual performance may vary over time. All operating parameters, including "Typicals" must be validated for each customer application by customer's technical experts. **onsemi** does not convey any license under any of its intellectual property rights nor the rights of others. **onsemi** products are not designed, intended, or authorized for use as a critical component in life support systems or any FDA Class 3 medical devices or medical devices with a same or similar classification in a foreign jurisdiction or any devices intended for implantation in the human body. Should Buyer purchase or use **onsemi** products for any such unintended or unauthorized application, Buyer shall indemnify and hold **onsemi** and its officers, employees, subsidiaries, affiliates, and distributors harmless against all claims, costs, damages, and expenses, and reasonable attorney fees arising out of, directly or indirectly, any claim of personal injury or death associated with such unintended or unauthorized use, even if such claim alleges that **onsemi** was negligent regarding the design or manufacture of the part. **onsemi** is an Equal Opportunity/Affirmative Action Employer. This literature is subject to all applicable copyright laws and is not for resale in any manner.

ADDITIONAL INFORMATION

TECHNICAL PUBLICATIONS:

Technical Library: www.onsemi.com/design/resources/technical-documentation
onsemi Website: www.onsemi.com

ONLINE SUPPORT: www.onsemi.com/support

For additional information, please contact your local Sales Representative at www.onsemi.com/support/sales