

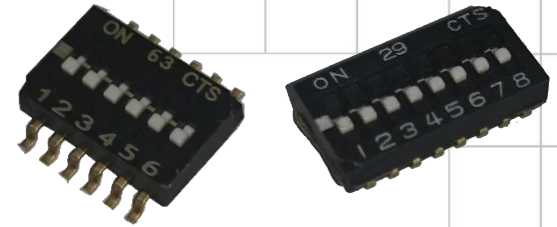

# Series 218

## Half Pitch, SMD DIP Switch

- Removable tape seal to withstand IR vapor phase or wave soldering temperatures, and board washing
- Gull-wing and “J” bend terminal configurations
- Low profile actuators prevent accidental actuation
- SPST configuration available
- 0.6mm/.024” actuator travel
- Optional top tape seal for board spray washing



### Description

Positive detent separated from contactor causes contactor does not deflect during actuation. Unique compact type design allows to be used at mini size application. Optional sealed structure is optimized for board washing during soldering process. It makes it the ideal choice for any server, security and HVAC systems

### Ordering Information

Series	Number of Switch Positions	Low Profile Actuator	Bottom Epoxy Seal	Top Tape Seal	Terminal Type	Packaging Type	Actuation Preset																																								
218-	12	LP	S	T	J	R	F																																								
	<table border="1"> <thead> <tr> <th>Code</th> <th>No. of switch positions</th> </tr> </thead> <tbody> <tr> <td>2</td> <td>2 positions</td> </tr> <tr> <td>4</td> <td>4 positions</td> </tr> <tr> <td>6</td> <td>6 positions</td> </tr> <tr> <td>8</td> <td>8 positions</td> </tr> <tr> <td>10</td> <td>10 positions</td> </tr> <tr> <td>12</td> <td>12 positions</td> </tr> </tbody> </table>	Code	No. of switch positions	2	2 positions	4	4 positions	6	6 positions	8	8 positions	10	10 positions	12	12 positions		<table border="1"> <thead> <tr> <th>Code</th> <th>Top tape seal</th> </tr> </thead> <tbody> <tr> <td>Blank</td> <td>No top tape seal</td> </tr> <tr> <td>T</td> <td>Top tape seal</td> </tr> </tbody> </table>	Code	Top tape seal	Blank	No top tape seal	T	Top tape seal		<table border="1"> <thead> <tr> <th>Code</th> <th>Spec.</th> </tr> </thead> <tbody> <tr> <td>Blank</td> <td>Anti-static tube packaging</td> </tr> <tr> <td>R</td> <td>Tape &amp; reel packaging</td> </tr> </tbody> </table>	Code	Spec.	Blank	Anti-static tube packaging	R	Tape & reel packaging		<table border="1"> <thead> <tr> <th>Code</th> <th>Spec.</th> </tr> </thead> <tbody> <tr> <td>Blank</td> <td>Gull wing terminal</td> </tr> <tr> <td>J</td> <td>J bend terminal</td> </tr> </tbody> </table>	Code	Spec.	Blank	Gull wing terminal	J	J bend terminal		<table border="1"> <thead> <tr> <th>Code</th> <th>Spec.</th> </tr> </thead> <tbody> <tr> <td>Blank</td> <td>Ship at ON position</td> </tr> <tr> <td>F</td> <td>Ship at OFF position</td> </tr> </tbody> </table>	Code	Spec.	Blank	Ship at ON position	F	Ship at OFF position
Code	No. of switch positions																																														
2	2 positions																																														
4	4 positions																																														
6	6 positions																																														
8	8 positions																																														
10	10 positions																																														
12	12 positions																																														
Code	Top tape seal																																														
Blank	No top tape seal																																														
T	Top tape seal																																														
Code	Spec.																																														
Blank	Anti-static tube packaging																																														
R	Tape & reel packaging																																														
Code	Spec.																																														
Blank	Gull wing terminal																																														
J	J bend terminal																																														
Code	Spec.																																														
Blank	Ship at ON position																																														
F	Ship at OFF position																																														

Notes: Contact CTS for other common features not listed.

## Electrical Specifications

Parameter	Conditions & Remarks	Min	Max	Unit
Circuit	SPST	2	12	position
Contact Resistance	Initial		100	milliohms
	At end of life		100	
Insulation Resistance	Between insulated terminals	100		megohms
Dielectric Strength	350 VAC between adjacent switches		1	minute
Actuation Life	25mA @ 24 VDC		1,000	cycles
Switch Capacitance	Between adjacent closed switches		10	pF
			100	
Nonswitching Rating			or	mA or VDC
			50	

## Mechanical and Environmental

Soldering	Maximum reflow temperature, 250°C for 30 seconds
MSL	Level 1
RoHS	Lead-Free. Fully compliant to RoHS Directive 2011/65/EU
Shock	Per MIL-STD-202G, method 213B, condition A( 50G's) with no contact inconsistencies greater than 1 microsecond
Vibration	Per MIL-STD-202G, method 204D, condition B ( .06" or 15G's between 10 HZ to 2K HZ) with no contact inconsistencies greater than 1 microsecond
Coplanarity	0.1mm/.004" maximum
Seal	Bottom epoxy seal standard Top tape seal optional
Marking	Special marking available-consult CTS
Packaging:	Standard anti-static tube packaging Optional tape and reel packaging
Operating Temperature Range	-55°C to +85°C
Storage Temperature Range	-55°C to +85°C

## Soldering Profile

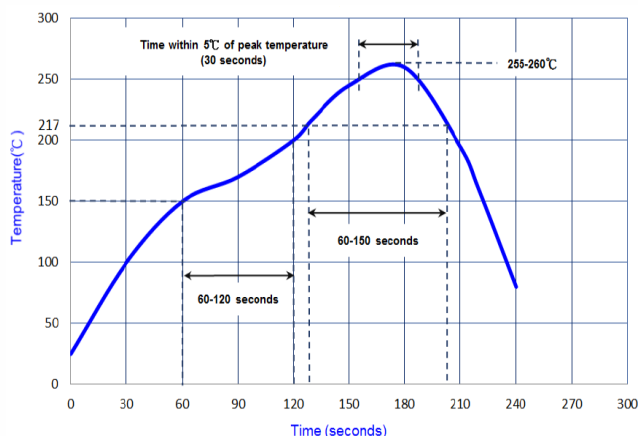

### Mechanical Specifications

Figure 1 – Surface Mount J Bend Terminal

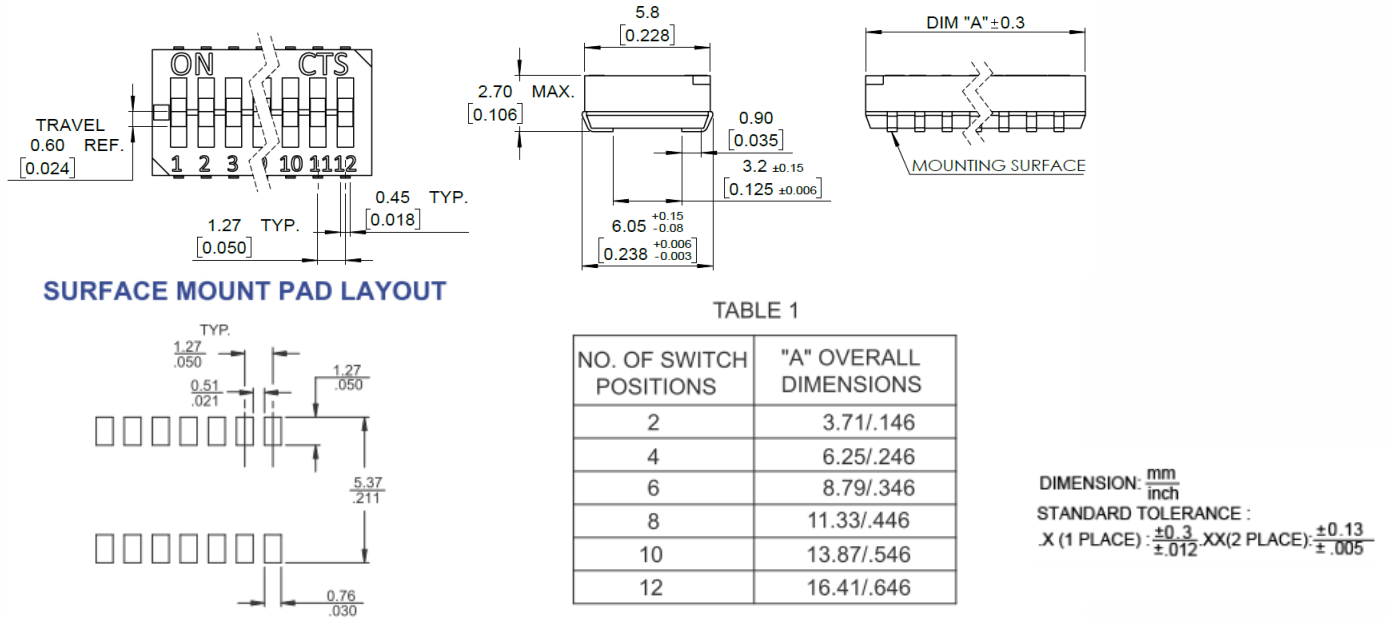
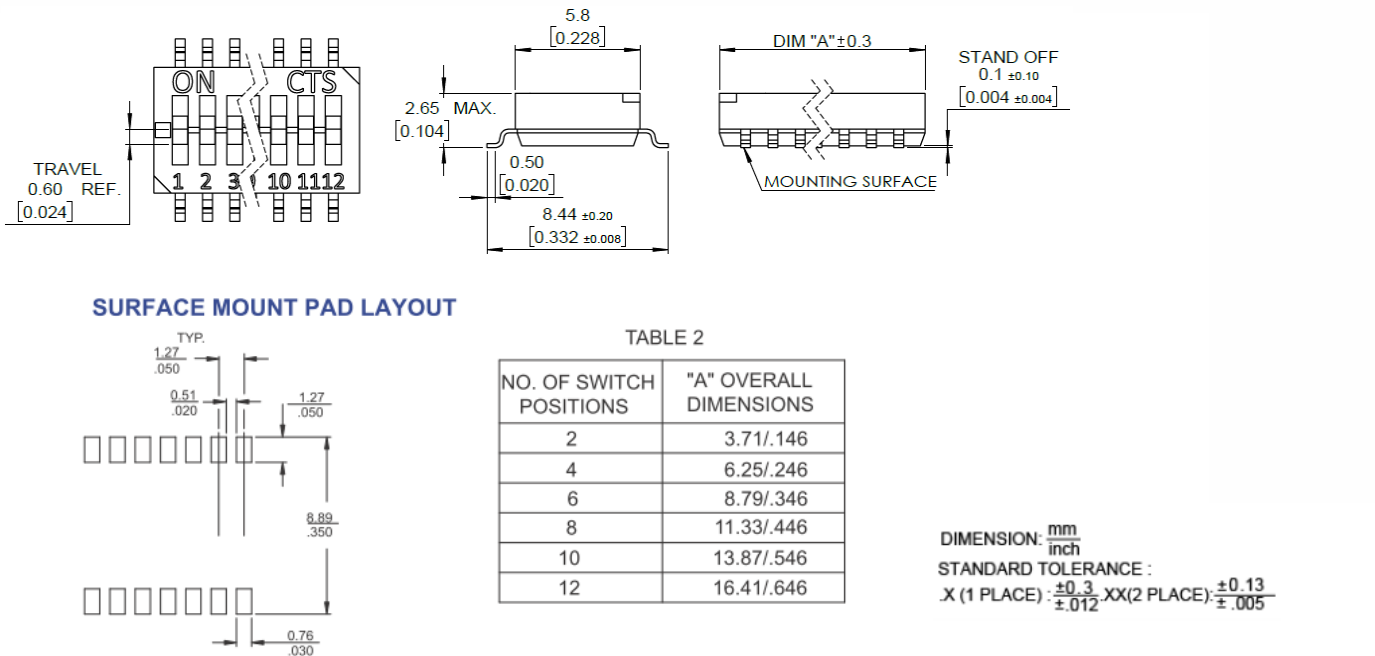

Figure 2 – Surface Mount Gull Wing Terminal



Packing: Tape and Reel

Unit: mm

SW Section	Fig	Bo	W	F
2	I	4.51	16.0	7.50
4	I	7.05	16.0	7.50
6	I	9.75	16.0	7.50
8	I	12.13	24.0	11.50
10	I	14.67	24.0	11.50
12	I	17.22	24.0	11.50



SPECIFIED REEL PARTS DIMENSIONS:

Unit: mm

SW Section	W1	W2	W3
2	16.4	22.4 MAX.	15.9 MIN./19.5 MAX.
4	16.4	22.4 MAX.	15.9 MIN./19.5 MAX.
6	16.4	22.4 MAX.	15.9 MIN./19.5 MAX.
8	24.4	30.4 MAX.	23.9 MIN./27.4 MAX.
10	24.4	30.4 MAX.	23.9 MIN./27.4 MAX.
12	24.4	30.4 MAX.	23.9 MIN./27.4 MAX.

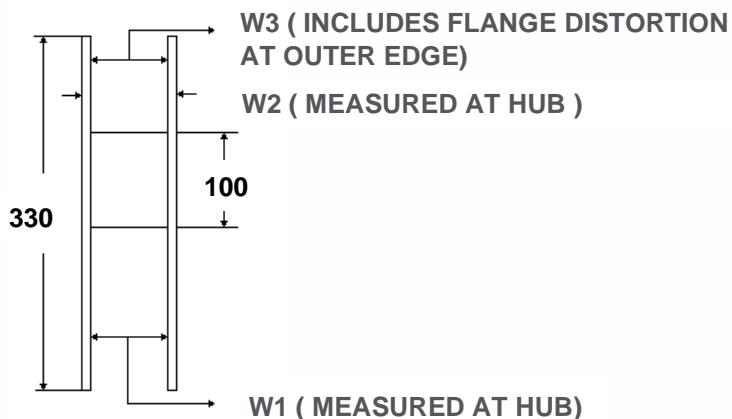

1. TAPE SPROCKET HOLE PITCH :  $4.0 \pm 0.1\text{MM}$   
ALL SMT ASSEMBLING MACHINES WILL PICK-UP THE COMPONENT FROM THE POINT, WHICH IS LOCATED IN THE CENTRE OF TWO ADJACENT SPROCKET HOLES IN FEEDING DIRECTION. THIS MUST BE TAKEK INTO ACCOUNT WHEN DESIGNING THE LOCATION OF THE COMPONENT IN T&R POCKET.
2. RECOMMENDED PART ORIENTATION IN TAPE & REEL POCKET.  
ORIENT SWITCH TERMINAL #1 TO THE SIDE OF ROUND SPROCKET HOLES, SEE PICTURE BELOW.

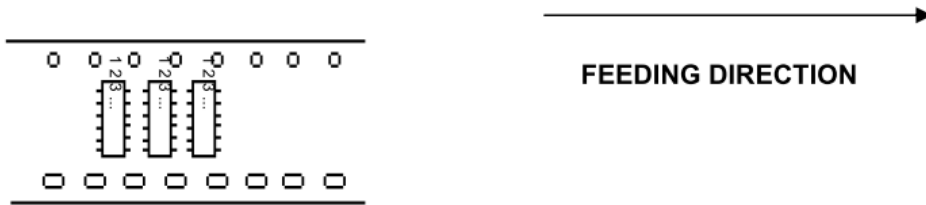

- 3 LENGTH OF TAPE  
THERE SHALL BE A LEADER OF 400mm MINIMUM WHICH IS SEALED ONTO EMPTY CARRIER TAPE, SEE PICTURE BELOW.

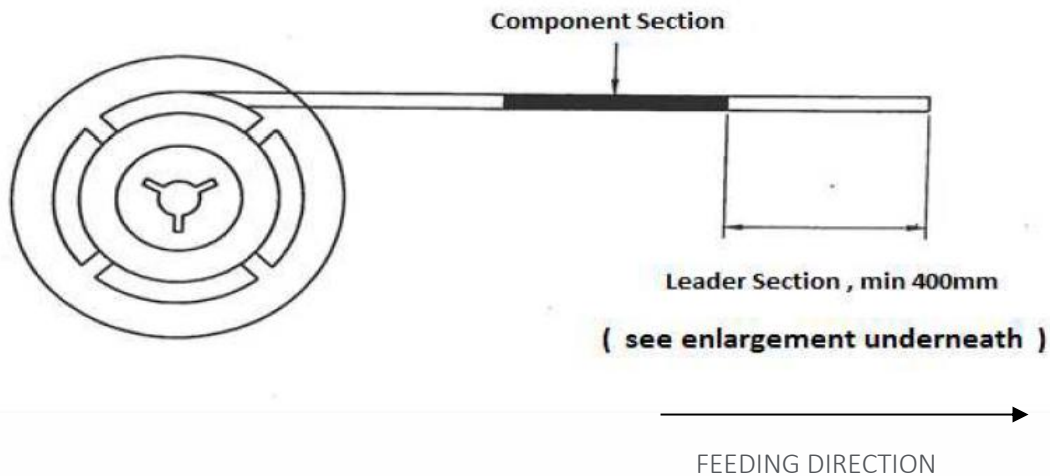

4. TAPE BREAK FORCE, PEEL STRENGTH AND ANGLE.  
REQUIRED SETTINGS :
- TOP COVER TAPE PEEL FORCE : 10 ~ 130 gm
  - ANGLE BETWEEN THE TOP COVER TAPE AND THE DIRECTION OF FEED DURING PEEL OFF :  $165^{\circ} \sim 180^{\circ}$



THE COVER TAPES MAY NOT EXTEND OVER THE EDGE OF THE CARRIER TAPE OR COVER ANY PART OF THE SPROCKETS HOLES.

# Mouser Electronics

Authorized Distributor

Click to View Pricing, Inventory, Delivery & Lifecycle Information:

[CTS:](#)

[218-12LPST](#) [218-4LPSTR](#) [218-6LPSTR](#) [218-6LPSTJ](#) [218-8LPSTR](#) [218-8LPSTJ](#) [218-10LPSTR](#) [218-10LPSTJ](#)  
[218-12LPSTR](#) [218-12LPSTJ](#) [218-10LPST](#) [218-2LPST](#) [218-2LPSTJ](#) [218-2LPSTR](#) [218-4LPST](#) [218-6LPST](#) [218-](#)  
[8LPST](#) [218-4LPSJF](#) [218-6LPSTJRF](#) [218-4LPSTJR](#) [218-4LPSTJ](#) [218-2LPSTF](#) [218-4LPSTRF](#) [218-6LPS](#) [218-](#)  
[4LPSJRF](#) [218-4LPS](#) [218-8LPS](#) [218-2LPS](#) [218-4LPSJ](#) [218-4LPSTF](#) [218-6LPSTRF](#) [218-2LPSTRF](#) [218-8LPSTRF](#)  
[218-06LPSTJF](#) [218-2LPSTJRF](#) [218-8LPSTJRF](#) [218-10LPSRF](#) [218-10LPSTF](#) [218-8LPSTF](#) [218-12LPSTJRF](#) [218-](#)  
[2LPSR](#) [218-6LPSF](#) [218-8LPSRF](#) [218-12LPSJRF](#) [218-4LPSR](#) [218-4LPSRF](#) [218-12LPSJR](#) [218-12LPSTRF](#) [218-](#)  
[2LPSTJR](#) [218-6LPSJ](#) [218-8LPSF](#) [218-8LPSTJR](#) [218-10LPS](#) [218-10LPSTJF](#) [218-2LPSTJF](#) [218-6LPSJF](#) [218-](#)  
[10LPSJRF](#) [218-12LPSF](#) [218-8LPSJR](#) [218-10LPSTJRF](#) [218-12LPSR](#) [218-12LPSRF](#) [218-2LPSF](#) [218-2LPSJ](#) [218-](#)  
[8LPSJ](#) [218-12LPSJ](#) [218-12LPSTJR](#) [218-2LPSJRF](#) [218-4LPSJR](#) [218-8LPSR](#) [218-10LPSTRF](#) [218-6LPSJR](#) [218-](#)  
[6LPSJRF](#) [218-10LPSF](#) [218-8LPSJF](#) [218-10LPSR](#) [218-12LPSJF](#) [218-2LPSRF](#) [218-6LPSTJF](#) [218-4LPSF](#) [218-](#)  
[4LPSTJF](#) [218-6LPSR](#) [218-6LPSRF](#) [218-6LPSTF](#) [218-10LPSJF](#) [218-10LPSJR](#) [218-12LPS](#) [218-12LPSTF](#) [218-](#)  
[12LPSTJF](#) [218-4LPSTJRF](#) [218-8LPSJRF](#) [218-8LPSTJF](#) [218-2LPSJF](#) [218-2LPSJR](#) [218-10LPSTJR](#) [218-10LPSJ](#)  
[218-6LPSTJR](#) [218-8LPSTROFF](#)