

0.5 Amp

- 0.5A Switching Regulator
- Wide Input Range
- Compact SMD Package
- Operating Temperature -40 °C to +100 °C
- Remote On/Off
- Very High Efficiency up to 97%
- Output Voltage Trim
- Tape & Reel Package Available
- 3 Year Warranty

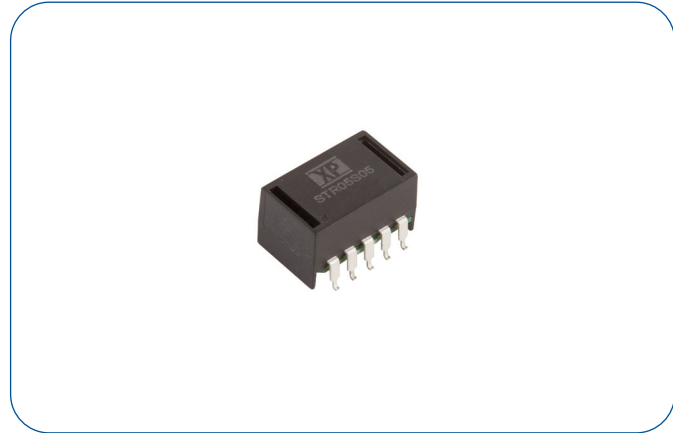

Dimensions:

STR05:

0.60 x 0.49 x 0.36" (15.30 x 12.35 x 9.24 mm)

Models & Ratings

Input voltage	Output voltage	Trim range	Output current	Maximum capacitive load	Efficiency		Model number
					@min input	@max input	
4.75 - 32V	1.5V	1.4 - 2.5V	500 mA	220 μ F	73%	63%	STR05S1V5
	1.8V	1.5 - 3.0V			82%	71%	STR05S1V8
	2.5V	1.5 - 3.0V			87%	77%	STR05S2V5
	3.3V	3.0 - 5.5V			91%	81%	STR05S3V3
6.5 - 32V	5.0V	3.0 - 8.0V			94%	86%	STR05S05
8 - 32V	6.5V	3.3 - 11.0V			95%	88%	STR05S6V5
11 - 32V	9.0V	4.5 - 12.6V			96%	92%	STR05S09
15 - 32V	12.0V	4.5 - 13.5V			97%	94%	STR05S12
18 - 32V	15.0V	4.5 - 15.5V			97%	95%	STR05S15

Mechanical Details

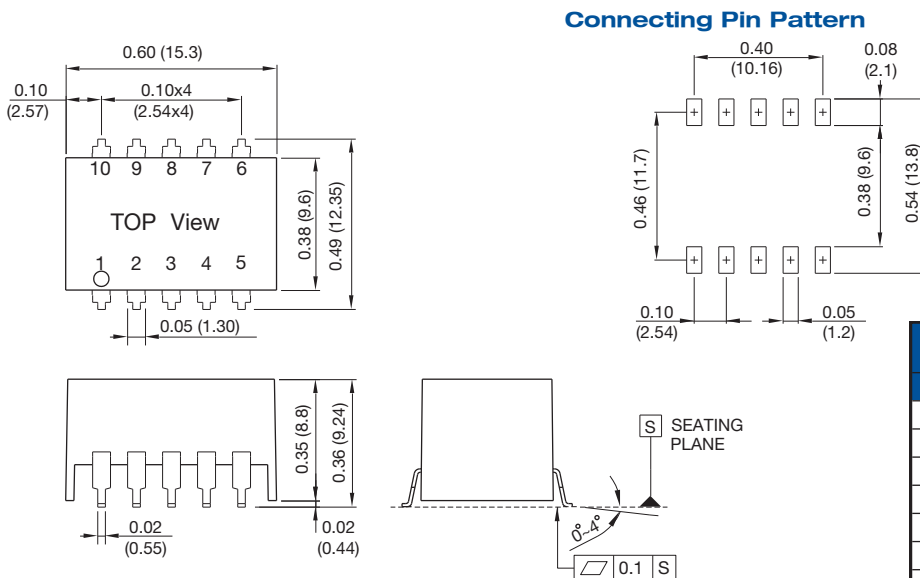

Pin Connections	
Pin	Function
1	+Vin
2	+Vin
3	GND
4	+Vout
5	+Vout
6	Vadj.
7	GND
8	GND
9	GND
10	Remote On/Off

Notes

1. All dimensions are in inches (mm)
2. Weight: 0.004 lbs (1.7 g) approx.
3. Tolerance: X.XX \pm 0.01 (X.X \pm 0.25)
X.XXX \pm 0.005 (X.XX \pm 0.13)
4. Pin Tolerance: \pm 0.002 (\pm 0.05)

Input

Characteristic	Minimum	Typical	Maximum	Units	Notes & Conditions
Input Voltage Range			32	VDC	See Models and Ratings table. A 22 μ F / 50 V capacitor is required across the input for voltages above 28 VDC. Input voltages must be >1.5 V higher than output voltage for 3.3 V to 5 V versions and >3.0V for 6.5 V to 15 V versions
Input Filter	Internal Capacitor				
Input Surge			34	VDC for 1 s	
Input Current - No Load		5		mA	
Input Current - Remote On/Off			35	μ A	At 24 V input
Remote On/Off	ON: Logic high (2.4 - 5 V) or open circuit OFF: Logic low (<1.6 V) or short pin 10 to pin 7, 8 or 9 Input current is 35 μ A max at nominal input voltage when output is remotely turned off				

Output

Characteristic	Minimum	Typical	Maximum	Units	Notes & Conditions
Output Voltage	1.4		15.5	VDC	See Models and Ratings table
Initial Set Accuracy		± 2.0	± 3.0	%	
Minimum Load				A	No minimum load required
Line Regulation		± 0.2	± 0.4	%	1.5 V to 6.5 V
		± 0.1	± 0.2		9 V to 15 V
Load Regulation		± 0.4	± 0.6	%	1.5 V to 6.5 V
		± 0.25	± 0.4		9 V to 15 V
Transient Response		2		% deviation	Recovery within 1% in less than 100 μ s for a 50% load change.
Ripple & Noise		30		mV pk-pk	1.5V to 6.5V. 20 MHz bandwidth. Measured using 0.47 μ F ceramic capacitor.
		40			9V to 15V. 20 MHz bandwidth. Measured using 0.47 μ F ceramic capacitor.
Short Circuit Protection					Continuous, with auto recovery
Maximum Capacitive Load			220	μ F	
Temperature Coefficient			0.02	%/ $^{\circ}$ C	

General

Characteristic	Minimum	Typical	Maximum	Units	Notes & Conditions
Efficiency		94		%	See Models and Ratings table
Isolation: Input to Output					No isolation
Switching Frequency	280	330	380	kHz	
Mean Time Between Failure		2.0		MHrs	MIL-HDBK-217F, +25 $^{\circ}$ C GB
Weight		0.004 (1.7)		lb (g)	
Moisture Sensitivity Level	Level 2				IPC/JEDEC J-STD-020D.1
Case Flammability	UL 94V-0 Rated				Non conductive black plastic
Lead-Free Reflow Solder Process					IPC/JEDEC J-STD-020D.1

Environmental

Characteristic	Minimum	Typical	Maximum	Units	Notes & Conditions
Operating Temperature	-40		+100	$^{\circ}$ C	See Derating Curve.
Storage Temperature	-55		+125	$^{\circ}$ C	
Case Temperature			+95	$^{\circ}$ C	
Thermal Shutdown		160		$^{\circ}$ C	Measured internally
Humidity			95	%RH	Non-condensing
Cooling					Natural convection

Safety Approvals

Agency	Standard	Test Level	Notes & Conditions
CE	Meets all applicable directives		
UKCA	Meets all applicable legislation		

EMC: Emissions

Phenomenon	Standard	Test Level	Notes & Conditions
Conducted	EN55022	Class B	With external components, see application note
Radiated	EN55022	Class B	

EMC: Immunity

Phenomenon	Standard	Test Level	Criteria	Notes & Conditions
ESD	EN61000-4-2	±8 kV air discharge	A	
Radiated	EN61000-4-3	3 V/m	A	
EFT/Burst	EN61000-4-4	±0.5 kV	A	With external capacitor, suggested part is CHEMI-CON KY 330µF/100V
Conducted	EN61000-4-6	3 V rms	A	
Magnetic Fields	EN61000-4-8	3 A/m	A	

Mechanical Details

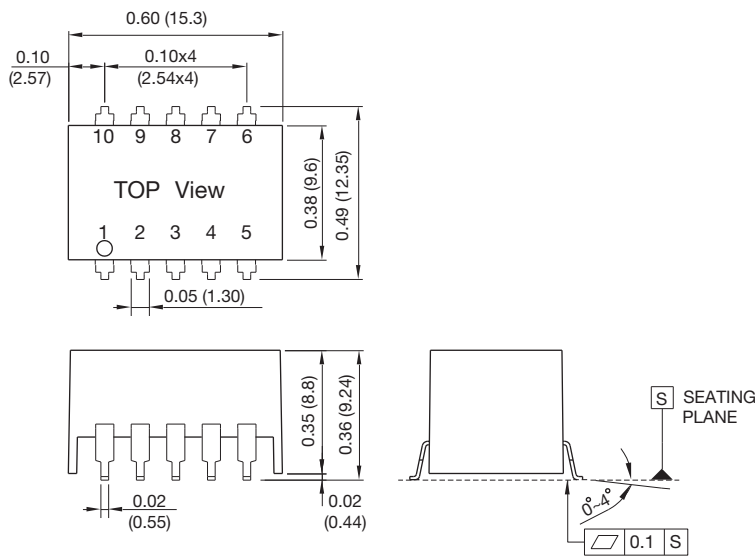

Connecting Pin Pattern

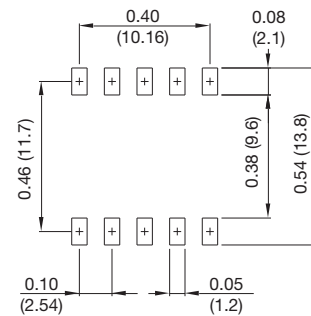

Notes

- All dimensions are in inches (mm)
- Weight: 0.004 lbs (1.7 g) approx.
- Tolerance: X.XX±0.01 (X.X±0.25)
X.XXX±0.005 (X.XX±0.13)
- Pin Tolerance: ±0.002 (±0.05)

Pin Connections	
Pin	Function
1	+Vin
2	+Vin
3	GND
4	+Vout
5	+Vout
6	Vadj.
7	GND
8	GND
9	GND
10	Remote On/Off

Application Notes

Derating Curve

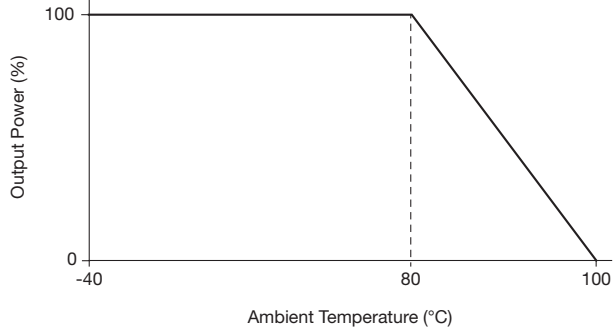

EMI Filter for Conducted Emissions

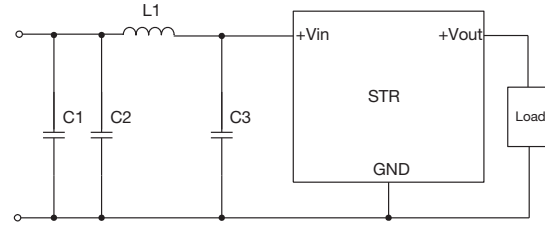

Class	C1	C2	C3	L1
Class A	-	4.7µF/50V 1206 MLCC	4.7µF/50V 1206 MLCC	Würth Elektronik NO. 744774033
Class B	4.7µF/50V 1206 MLCC	4.7µF/50V 1206 MLCC	4.7µF/50V 1206 MLCC	Würth Elektronik NO. 744774033

Output Trim Resistor Values

Vout(nom) Vout(adj)	STR05S1V5		STR05S1V8		STR05S2V5		STR05S3V3		STR05S05		STR05S6V5		STR05S09		STR05S12		STR05S15		
	1.5 VDC		1.8 VDC		2.5 VDC		3.3 VDC		5.0 VDC		6.5 VDC		9.0 VDC		12 VDC		15 VDC		
	R1	R2	R1	R2	R1	R2	R1	R2	R1	R2	R1	R2	R1	R2	R1	R2	R1	R2	
1.4V	1k																		
1.5V			3k		200														
1.8V		8.49k			12k														
2.5V		0.47k		11.8k															
3.0V				4.64k		44.2k	88.4k		17k										
3.3V									27k		15k								
3.8V								60.4k	42k		21.5k								
3.9V								28k	58k		30.1k								
4.5V								11.3k	180k		56.3k		26k		17k			10.5k	
4.9V								7.15k	850k		78.7k		36k		24k			15.8k	
5.0V								6.34k			86k		39k		26k			17.4k	
5.1V								5.9k		231k	97k		42k		28k			18.7k	
5.5V								3.9k		56.2k	154k		56k		36k			24.9k	
6.0V										29.3k	344k								
6.5V										14k			112k		63k			42.2k	
8.0V										2.32k		22.6k	400k		125k			78.7k	
9.0V												9.53k			200k			113k	
10.0V												3.92k		54.9k	345k			160k	
11.0V												825		16.5k	740k			232k	
12.0V														3.6k				340k	
12.6V														0k		180k		464k	
13.5V																57.6k		787k	
15.5V																			300k

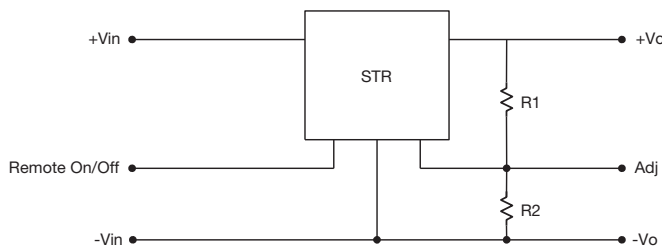

Mouser Electronics

Authorized Distributor

Click to View Pricing, Inventory, Delivery & Lifecycle Information:

[XP Power:](#)

[STR05S05-TR](#) [STR05S2V5](#) [STR05S6V5](#) [STR05S1V5-TR](#) [STR05S1V8](#) [STR05S15-TR](#) [STR05S15](#) [STR05S3V3-TR](#) [STR05S05](#) [STR05S6V5-TR](#) [STR05S1V5](#) [STR05S09-TR](#) [STR05S2V5-TR](#) [STR05S12](#) [STR05S09](#) [STR05S1V8-TR](#) [STR05S12-TR](#) [STR05S3V3](#)