

Universal limit switches

→ Series 83 840 0 Standard

- Adjustable metal head
- 4 positions 90°
- Metal case



Main specifications

	Steel plunger	Reinforced lever with plastic roller	Stepped adjustment roller lever
Housing			
Action			
Metal	Snap action		
General characteristics	83 840 0	83 841 0	83 842 0
Function	NO+NC	NO+NC	NO+NC
Sequence			
Mechanical characteristics			
Minimum operating force (N)	10	15	8
Minimum operating force (cmN)	-	-	-
Minimum total travel force (N)	22	25	15
Minimum total travel force (cmN)	-	-	-
Mechanical life (operations)	10 ⁷	10 ⁷	10 ⁷
Temperature limits use (°C)	-10 → +70	-10 → +70	-10 → +70
Weight (g)	310	310	310
Comments	Accessories for 83 843 0 (see Dimensions - Mounting accessories) Galvanized, passivated steel lever Thermoplastic roller Supplied with nut, washer and locating block loose		

General characteristics

Assigned insulation voltage (Ui) V	600
Thermal current (Ith) A	10
Use category	AC 15 : A600 DC 13 : P300

Product adaptations



- Approvals : UL/CSA



Adjustable roller lever	Adjustable lever with idle-return lever	Rotary head with momentary action Action to right and left	Top-mounted plunger with metal roller	Flexible metal lever
83 842 1	83 842 2	83 843 0	83 845 0	83 846 0
NO+NC	NO+NC	NO+NC	NO+NC	NO+NC
8	8	-	10	1.5
-	-	20	-	-
15	15	-	22	2.5
-	-	33	-	-
10 ⁷	10 ⁷	10 ⁷	10 ⁷	10 ⁷
-10 → +70	-10 → +70	-20 → +70	-10 → +70	-10 → +70
310	310	310	300	310

Principles

Function

Four-terminal double break two-way contact element (form Za). The contacts must be of the same polarity.



Curves

Operating curve for standard version

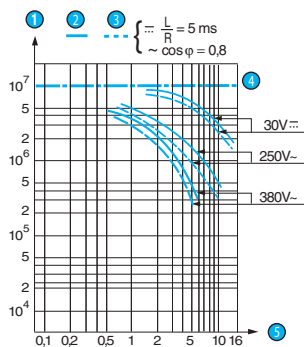

Dimensions

→ Product

Body

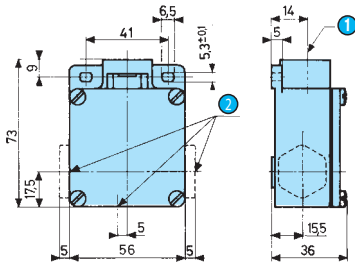

- ① Axis of head rotation
- ② No. 13 sealing gland

→ Actuators

83 840 0

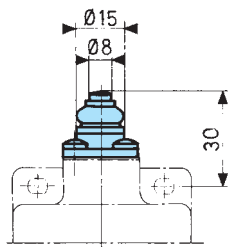

83 841 0

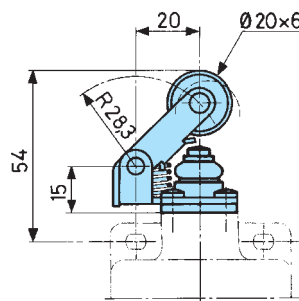

83 842 0

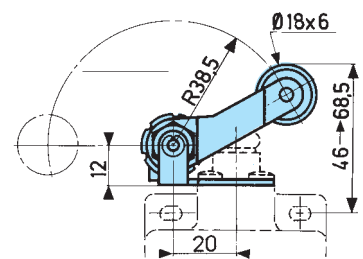

Min. angle between 2 successive adjustments 0°10'

83 842 1

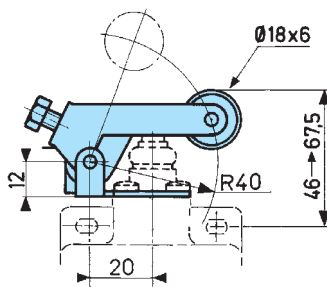

83 842 2

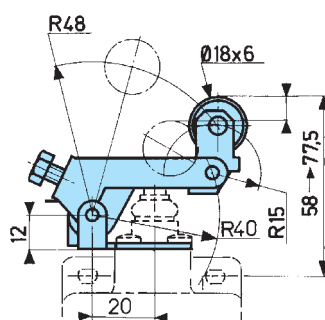

83 843 0

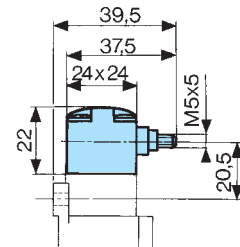

83 845 0

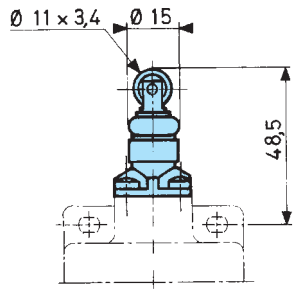

83 846 0

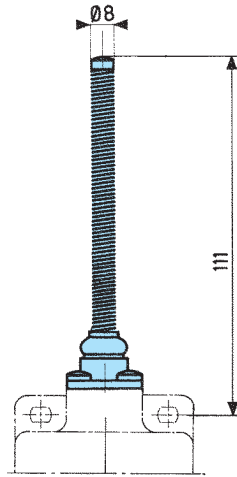

79 210 997 (for 83 843 0)

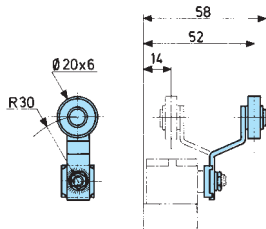

79 210 998 (for 83 843 0)

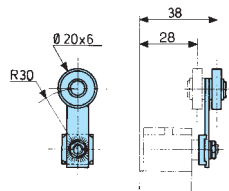

Lever settings or positions dictated by direction in which block 1 is fitted

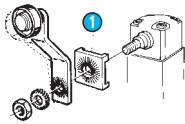

1 Block 1
Adjustable in 6° steps

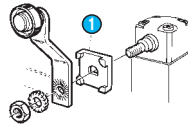

1 Block 1
Adjustable in 90° steps

Universal limit switches

→ Series 83 840 7 Positive break operation

- Adjustable metal head
- 4 positions 90°
- Plastic or metal cases



Main specifications

	Steel plunger	Reinforced lever with plastic roller
Housing		
Metal	83 840 7	83 841 7
Action		
Snap action		
General characteristics		
Function	NC	NC
Sequence	0 2,5 4F 6 mm	0 3 4,5F 6 mm
Snap action	1-2 1-2 0,7	1-2 1-2 0,7
Positive break operation		
Mechanical characteristics		
Minimum operating force (N)	10	15
Minimum operating force (cmN)	-	-
Minimum positive opening force (N)	10	15
Min. positive opening travel (cmN)	-	-
Minimum total travel force (N)	22	25
Minimum total travel force (cmN)	-	-
Mechanical life (operations)	10 ⁷	10 ⁷
Temperature limits use (°C)	-10 → +70	-10 → +70
Weight (g)	310	310

General characteristics

Assigned insulation voltage (Ui) V	600
Thermal current (Ith) A	2.5
Use category	AC 15 : C600 DC 13 : R 300
Short circuit test	Conforms to IEC 947.5.1 paragraph 8.34
Current peak	1000 A at 250 VAC 0.5 < cos φ < 0.7
Short circuit protection (SCPD)	Fuse 10 AgF

Product adaptations



- Approvals : UL/CSA



Stepped adjustment roller lever

Adjustable roller lever

Adjustable lever with idle-return lever

Rotary head with momentary action Action to right and left

Top-mounted plunger with metal roller

83 842 7

83 842 8

83 842 9

83 843 7

83 845 7

NC

NC

NC

NC

NC

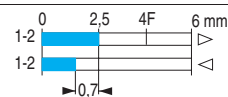
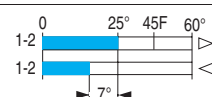
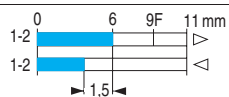
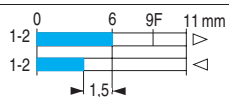
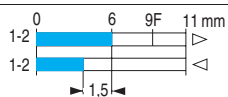

8	8	8	-	10
-	-	-	20	-
10	10	10	-	10
-	-	-	20	-
15	15	15	-	22
-	-	-	33	-
10 ⁷	10 ⁷	10 ⁷	10 ⁷	10 ⁷
-10 → +70	-10 → +70	-10 → +70	-20 → +70	-10 → +70
310	310	310	310	300

Principles

Function

Two-terminal double break contact element (form Y : normally closed contact) with positive break operation.



Curves

Operating curve for positive break version

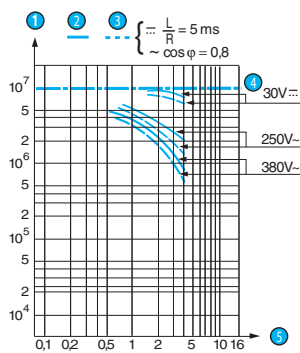

- ① Number of operations
- ② Resistive circuit
- ③ Inductive circuit
- ④ Mechanical life limit
- ⑤ Current in Amps

Dimensions

→ Product

Body

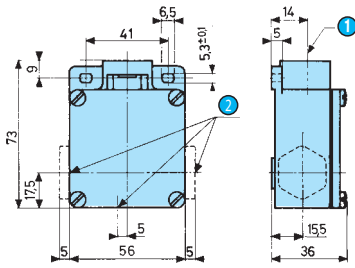

- 1 Axis of head rotation
- 2 No. 13 sealing gland

→ Actuators

83 840 7

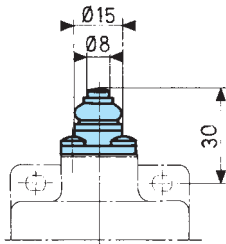

83 841 7

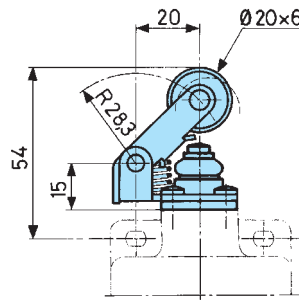

83 842 7

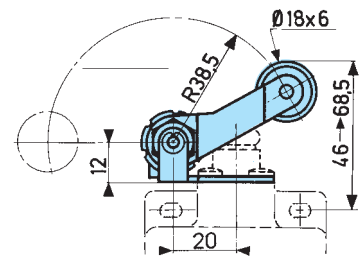

- 1 Min. angle between 2 successive adjustments
0°10

83 842 8

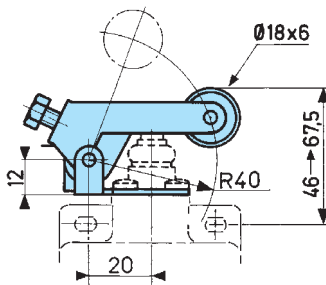

83 842 9

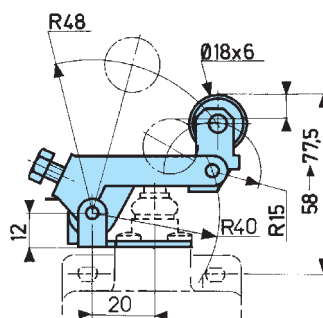

83 843 7

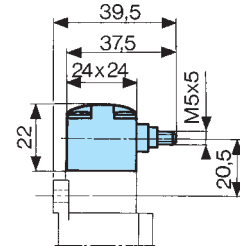

83 845 7

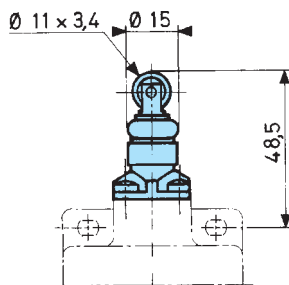

79 210 997 (for 83 843 7)

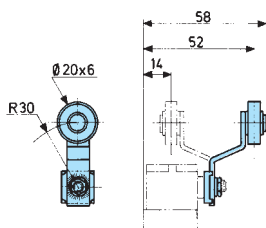

79 210 998 (for 83 843 7)

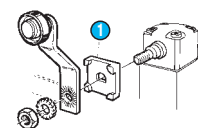
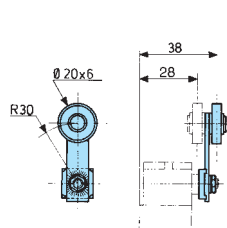

- 1 Block 1
Block 1 must not be mounted the other way round
Adjustable in 90° steps

Mouser Electronics

Authorized Distributor

Click to View Pricing, Inventory, Delivery & Lifecycle Information:

[Crouzet:](#)

[83840001](#) [83841001](#) [83843701](#) [83840701](#) [83845001](#) [83845701](#) [83846001](#) [83848001](#) [83842901](#)