

83870 with cable output Metal roller lever (2 directions of attack) Part number 83873101

- IP 66/67
- Metal case
- cUL approval

Part numbers

Type	Characteristics	Type of output
83873 101 Metal roller lever (2 directions of attack)	Standard	Cable length 1 m

Specifications

Conformity to standards	IEC / EN 60947.5.1 Dimensional conformity : NFC 63145 Low voltage directive : 73/23/EEC and 93/68/EEC Electric shock protection : NFC 20030 ou IEC 60536 class 1, degree of pollution 3
Protection against electric shocks	
Degree of protection IEC 60529	
Degree of protection according to NEMA 250	Type 1, 3, 4, 6, 13

Electrical characteristics

Connection	
Operating temperature (°C)	-25 → +70 °C
Assigned impulse voltage (Uimp) - V	2500
Assigned insulation voltage Ui (V)	500
Thermal current I (A)	10
Low-load switching - Minimum voltage (V)	10
Low-load switching - Minimum current (mA)	100
Assigned working characteristics (EN 60 947.5.1, UL 508)	A300 = AC15 240 V 3 A / 120 V 6 A Alternating current Q150 = DC13 125 V 0.55 A Direct current
Electrical life according to IEC 947-5-1 appendix C	250 V 3 A AC15 500,000 operations 24 V 8 W DC13 500,000 operations
Electrical protection	Integral protective earth conductor Short-circuit protection device : IEC/EN 60947-5-1 Fuse 6 AgG
Approvals	UL 508, UL 50

Mechanical characteristics

Sequence Snap action	
Minimum operating force (N)	-
Minimum operating force (Nm)	0,15
Minimum total travel force (N)	-
Minimum total travel force (Nm)	0,35
Min. positive opening travel (N)	-
Min. positive opening travel (Nm)	0,15
Mechanical life (millions of operations)	10
Vertical approach speed	-
Horizontal approach speed (30° cam)	1 mm/min → 1,5 m/s
Weight (g)	210

Principles

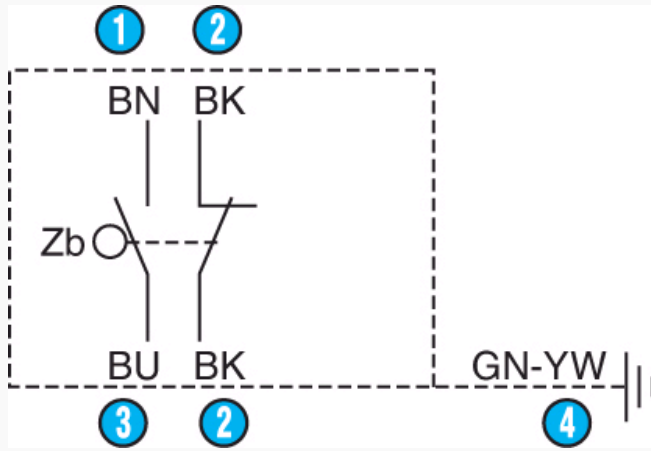

Function

Four-terminal double break two-way contact element (form Zb) with positive opening NC contacts. The 2 moving contacts are electrically isolated from one another.

N°	Legend
①	Brown
②	Black
③	Blue
④	Green-yellow

Dimensions (mm)

Product

83 873 1

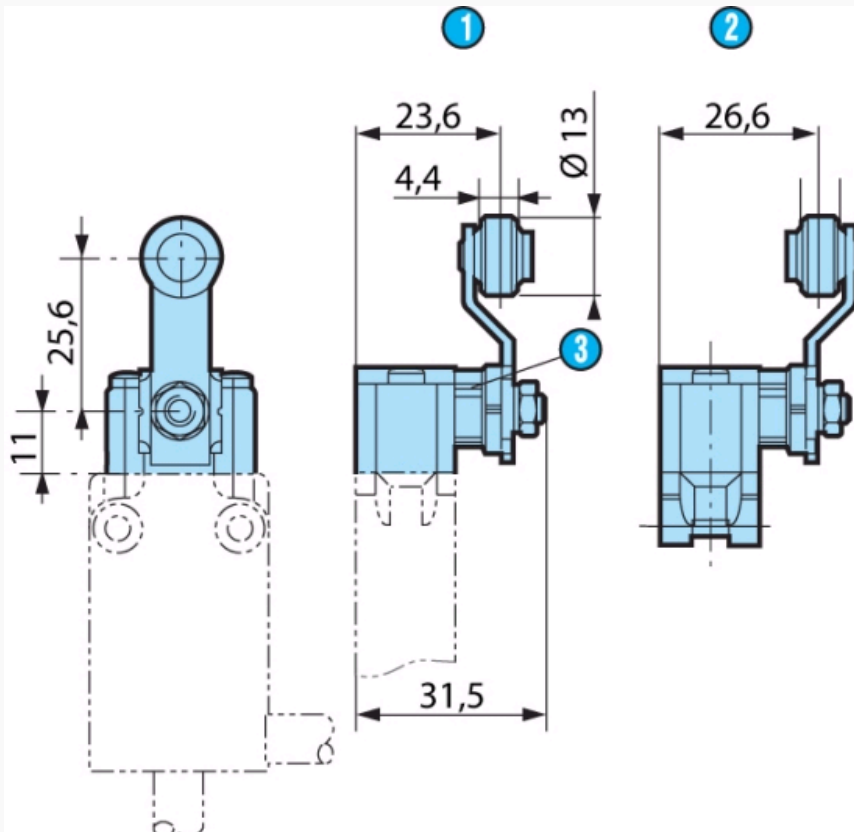

83 873 0

N°	Legend
----	--------

①	Offset A
②	Offset B (on request)
③	POP marking

Other information

For other accessories and special contacts, or special modes of operation : please consult us.

Product adaptations



- Contact type
- Rear output
- Protective scraper seal
- Length of cable/connector/stripping
- Special marking

Mouser Electronics

Authorized Distributor

Click to View Pricing, Inventory, Delivery & Lifecycle Information:

[Crouzet:](#)

[83873101](#)