

CAS350M12BM3

1200 V, 350 A, Silicon Carbide, Half-Bridge Module

V_{DS}	1200 V
I_{DS}	350 A

Technical Features

- Industry Standard 62mm Footprint
- Ultra Low Loss , High-Frequency Operation
- Zero Reverse Recovery from Diodes
- Zero Turn-off Tail Current from MOSFET
- Normally-off, Fail-safe Device Operation
- Copper Baseplate and Aluminum Nitride Insulator

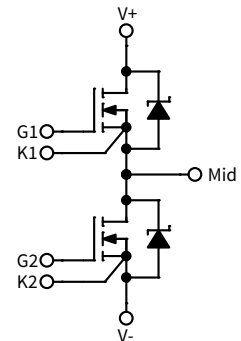

Applications

- Induction Heating
- Motor Drives
- Renewables
- Railway Auxiliary & Traction
- EV Fast Charging
- UPS and SMPS

System Benefits

- 62mm Form Factor Enables System Retrofit
- Increased System Efficiency, due to Low Switching & Conduction Losses of SiC

Maximum Parameters (Verified by Design)

Parameter	Symbol	Min.	Typ.	Max.	Unit	Test Conditions	Note
Drain-Source Voltage	V_{DS}			1200	V		
Gate-Source Voltage, Maximum Value	$V_{GS\ max}$	-8		+19		Transient, <100 ns	Fig. 33
Gate-Source Voltage, Recommended	$V_{GS\ op}$	-4		+15		Static	
DC Continuous Drain Current	I_D		417		A	$V_{GS} = 15\ V, T_c = 25\ ^\circ C, T_{VJ} \leq 175\ ^\circ C$	Fig. 21
			318			$V_{GS} = 15\ V, T_c = 90\ ^\circ C, T_{VJ} \leq 175\ ^\circ C$	
DC Source-Drain Current (Diode)	I_{SD}		440			$V_{GS} = -4\ V, T_c = 25\ ^\circ C, T_{VJ} \leq 175\ ^\circ C$	
			315			$V_{GS} = -4\ V, T_c = 90\ ^\circ C, T_{VJ} \leq 175\ ^\circ C$	
Pulsed Drain Current	$I_{D\ (pulsed)}$			700		t_{pmax} limited by T_{VJmax} $V_{GS} = 15\ V, T_c = 25\ ^\circ C$	
Virtual Junction Temperature	$T_{VJ\ op}$	-40		150	$^\circ C$	Operation	
				175		Intermittent with Reduced Life	

MOSFET Characteristics (Per Position) ($T_{VJ} = 25\text{ }^{\circ}\text{C}$ unless otherwise specified)

Parameter	Symbol	Min.	Typ.	Max.	Unit	Test Conditions	Note
Drain-Source Breakdown Voltage	$V_{(BR)DSS}$	1200				$V_{GS} = 0\text{ V}$, $T_{VJ} = -40\text{ }^{\circ}\text{C}$	
Gate Threshold Voltage	$V_{GS(th)}$	1.8	2.5	3.6	V	$V_{DS} = V_{GS}$, $I_D = 85\text{ mA}$	
			2.0			$V_{DS} = V_{GS}$, $I_D = 85\text{ mA}$, $T_{VJ} = 175\text{ }^{\circ}\text{C}$	
Zero Gate Voltage Drain Current	I_{DSS}		8.2	1128	μA	$V_{GS} = 0\text{ V}$, $V_{DS} = 1200\text{ V}$	
Gate-Source Leakage Current	I_{GSS}		40	400	nA	$V_{GS} = 15\text{ V}$, $V_{DS} = 0\text{ V}$	
Drain-Source On-State Resistance (Devices Only)	$R_{DS(on)}$		4.0	5.2	m Ω	$V_{GS} = 15\text{ V}$, $I_D = 350\text{ A}$	Fig. 2
			6.5			$V_{GS} = 15\text{ V}$, $I_D = 350\text{ A}$, $T_{VJ} = 150\text{ }^{\circ}\text{C}$	Fig. 3
Transconductance	g_{fs}		306		S	$V_{DS} = 20\text{ V}$, $I_D = 350\text{ A}$	Fig. 4
			292			$V_{DS} = 20\text{ V}$, $I_D = 350\text{ A}$, $T_{VJ} = 150\text{ }^{\circ}\text{C}$	
Turn-On Switching Energy, $T_{VJ} = 25\text{ }^{\circ}\text{C}$ $T_{VJ} = 125\text{ }^{\circ}\text{C}$ $T_{VJ} = 150\text{ }^{\circ}\text{C}$	E_{On}		5.0		mJ	$V_{DD} = 600\text{ V}$, $I_D = 350\text{ A}$, $V_{GS} = -4\text{ V}/15\text{ V}$, $R_{G(OFF)} = 0.5\text{ }\Omega$, $R_{G(ON)} = 0.5\text{ }\Omega$, $L = 25\text{ }\mu\text{H}$	Fig. 11 Fig. 13
Turn-Off Switching Energy, $T_{VJ} = 25\text{ }^{\circ}\text{C}$ $T_{VJ} = 125\text{ }^{\circ}\text{C}$ $T_{VJ} = 150\text{ }^{\circ}\text{C}$		E_{Off}		4.8			
Internal Gate Resistance	$R_{G(int)}$		2.53		Ω	$f = 100\text{ kHz}$, $V_{AC} = 25\text{ mV}$	
Input Capacitance	C_{iss}		25.7		nF	$V_{GS} = 0\text{ V}$, $V_{DS} = 800\text{ V}$, $V_{AC} = 25\text{ mV}$, $f = 100\text{ kHz}$	Fig. 9
Output Capacitance	C_{oss}		1.8				
Reverse Transfer Capacitance	C_{rss}		44.5		pF		
Gate to Source Charge	Q_{GS}		268		nC	$V_{DS} = 800\text{ V}$, $V_{GS} = -4\text{ V}/15\text{ V}$, $I_D = 350\text{ A}$, Per IEC60747-8-4 pg 21	
Gate to Drain Charge	Q_{GD}		244				
Total Gate Charge	Q_G		844				
FET Thermal Resistance, Junction to Case	R_{thJC}		0.116		$^{\circ}\text{C}/\text{W}$		Fig. 17

Diode Characteristics (Per Position) ($T_{VJ} = 25\text{ }^{\circ}\text{C}$ unless otherwise specified)

Parameter	Symbol	Min.	Typ.	Max.	Unit	Test Conditions	Notes
Diode Forward Voltage	V_F		2.0		V	$V_{GS} = -4\text{ V}$, $I_F = 350\text{ A}$, $T_{VJ} = 25\text{ }^{\circ}\text{C}$	Fig. 7
			2.5			$V_{GS} = -4\text{ V}$, $I_F = 350\text{ A}$, $T_{VJ} = 150\text{ }^{\circ}\text{C}$	
Reverse Recovery Time	t_{rr}		24.5		ns	$V_{GS} = -4\text{ V}$, $I_{SD} = 350\text{ A}$, $V_R = 800\text{ V}$ $di/dt = 13.0\text{ A/ns}$, $T_{VJ} = 150\text{ }^{\circ}\text{C}$	Fig. 32
Reverse Recovery Charge	Q_{rr}		5.0		μC		
Peak Reverse Recovery Current	I_{rrm}		341		A		
Reverse Recovery Energy, $T_{VJ} = 25\text{ }^{\circ}\text{C}$ $T_{VJ} = 125\text{ }^{\circ}\text{C}$ $T_{VJ} = 150\text{ }^{\circ}\text{C}$	E_{rr}		1.7		mJ	$V_{DS} = 600\text{ V}$, $I_D = 350\text{ A}$, $V_{GS} = -4\text{ V}/15\text{ V}$, $R_{G(ext)} = 0.5\text{ }\Omega$, $L = 25\text{ }\mu\text{H}$	Fig. 14 Note 1
			2.0				
Diode Thermal Resistance, JCT. to Case	R_{thJC}		0.112		$^{\circ}\text{C}/\text{W}$		Fig. 18

Note:

¹ SiC Schottky diodes do not have reverse recovery energy but still contribute capacitive energy.



Module Physical Characteristics

Parameter	Symbol	Min.	Typ.	Max.	Unit	Test Conditions	
Package Resistance, M1 (High-Side)	R_{3-1}		1.31		m Ω	$T_C = 25\text{ }^\circ\text{C}$, $I_{SD} = 350\text{ A}$, Note 2	
			1.84			$T_C = 125\text{ }^\circ\text{C}$, $I_{SD} = 350\text{ A}$, Note 2	
Package Resistance, M2 (Low-Side)	R_{1-2}		1.26			$T_C = 25\text{ }^\circ\text{C}$, $I_{SD} = 350\text{ A}$, Note 2	
			1.77			$T_C = 125\text{ }^\circ\text{C}$, $I_{SD} = 350\text{ A}$, Note 2	
Stray Inductance	L_{Stray}		11.1		nH	Between DC- and DC+, $f = 10\text{ MHz}$	
Case Temperature	T_C	-40		125	$^\circ\text{C}$		
Mounting Torque	M_S		4	5	5.5	N-m	Baseplate, M6-1.0 bolts
			4	5	5.5		Power Terminals, M6-1.0 bolts
Weight	W		300		g		
Case Isolation Voltage	V_{isol}	5			kV	AC, 50 Hz, 1 minute	
Clearance Distance			9		mm	Terminal to Terminal	
			30			Terminal to Baseplate	
Creepage Distance			30			Terminal to Terminal	
			40			Terminal to Baseplate	

Note:

²Total Effective Resistance (Per Switch Position) = MOSFET $R_{DS(on)}$ + Switch Position Package Resistance



Typical Performance

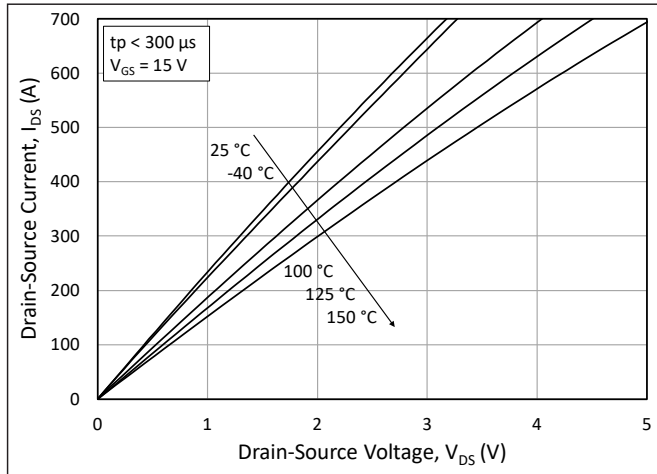

Figure 1. Output Characteristics for Various Junction Temperatures

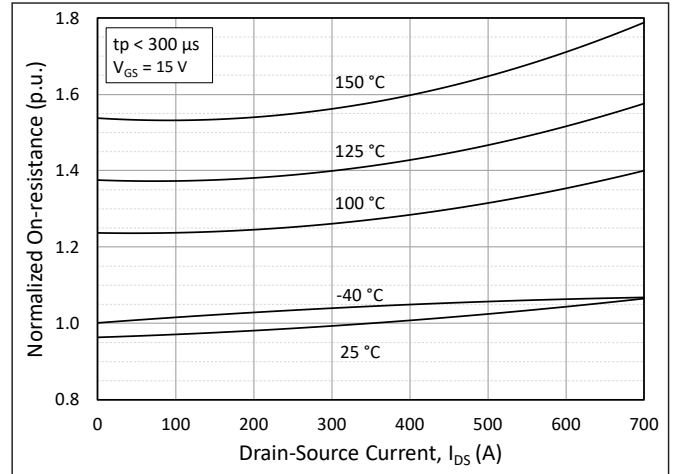

Figure 2. Normalized On-State Resistance vs. Drain Current for Various Junction Temperatures

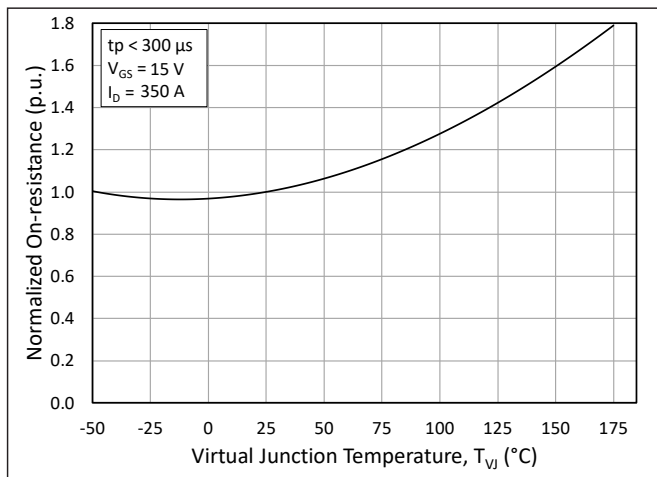

Figure 3. Normalized On-State Resistance vs. Junction Temperature

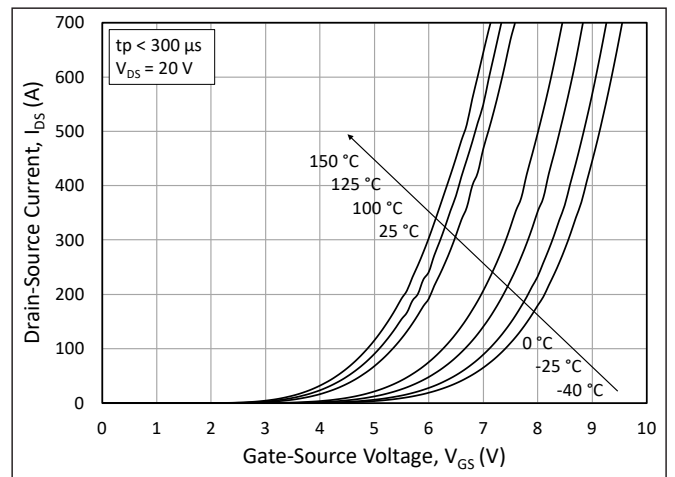

Figure 4. Transfer Characteristic for Various Junction Temperatures

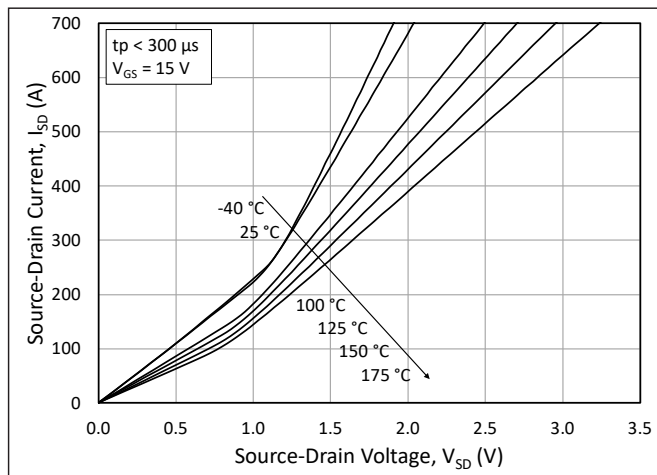

Figure 5. 3rd Quadrant Characteristic vs. Junction Temperatures at $V_{GS} = 15\text{ V}$

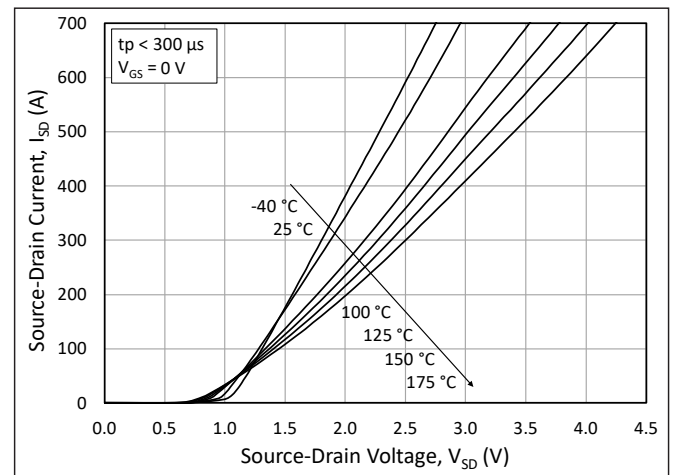

Figure 6. 3rd Quadrant Characteristic vs. Junction Temperatures at $V_{GS} = 0\text{ V}$ (Diode)



Typical Performance

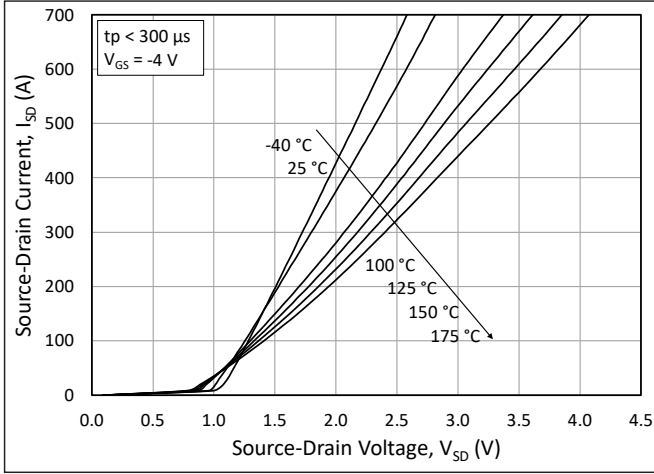

Figure 7. 3rd Quadrant Characteristic vs. Junction Temperatures at $V_{GS} = -4$ V (Diode)

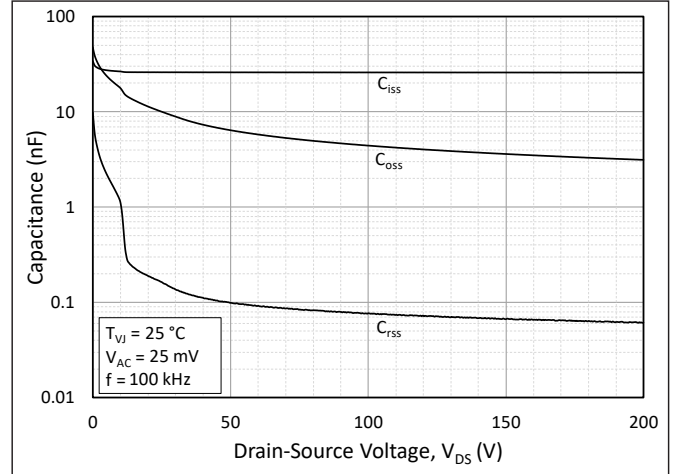

Figure 8. Typical Capacitances vs. Drain to Source Voltage (0 - 200V)

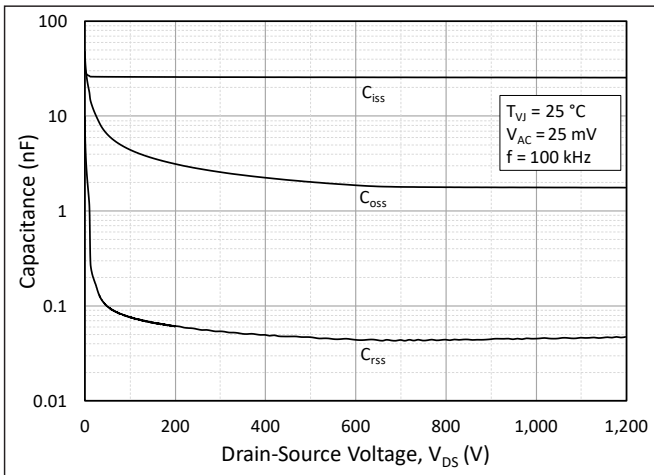

Figure 9. Typical Capacitances vs. Drain to Source Voltage (0 - 1200V)

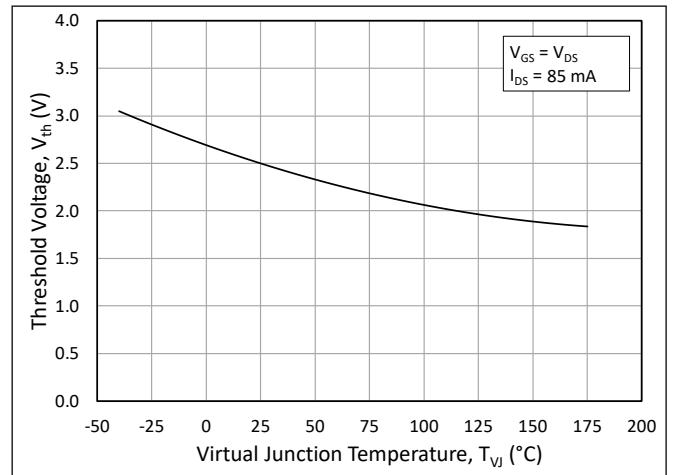

Figure 10. Threshold Voltage vs. Junction Temperature

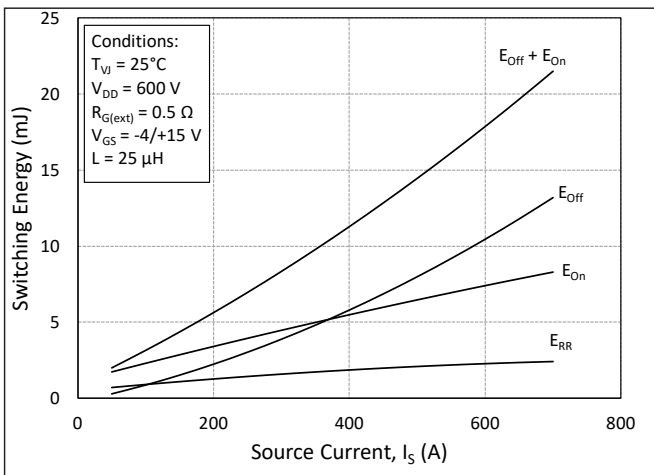

Figure 11. Switching Energy vs. Drain Current ($V_{DS} = 600$ V)

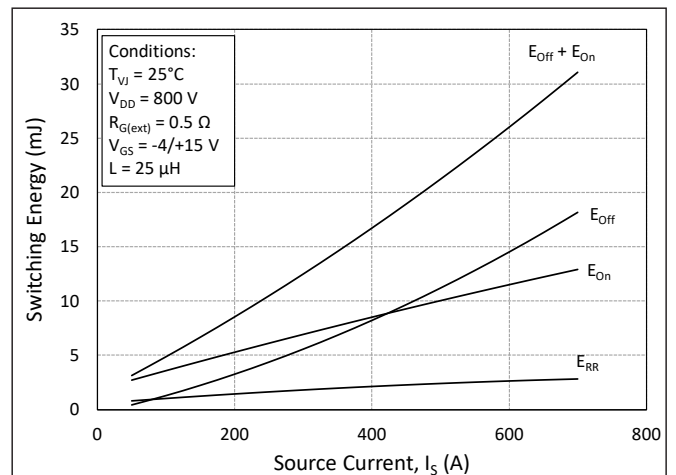

Figure 12. Switching Energy vs. Drain Current ($V_{DS} = 800$ V)



Typical Performance

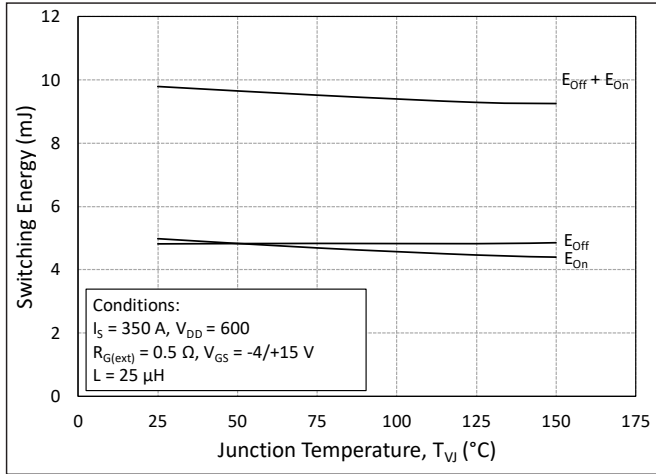

Figure 13. MOSFET Switching Energy vs. Junction Temperature

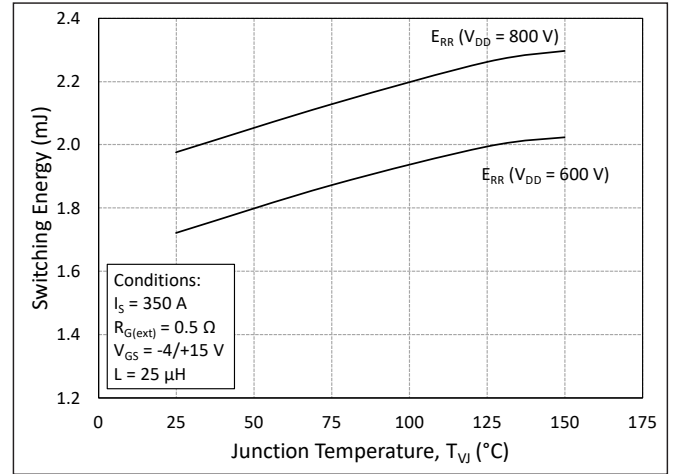

Figure 14. Reverse Recovery Energy vs. Junction Temperature

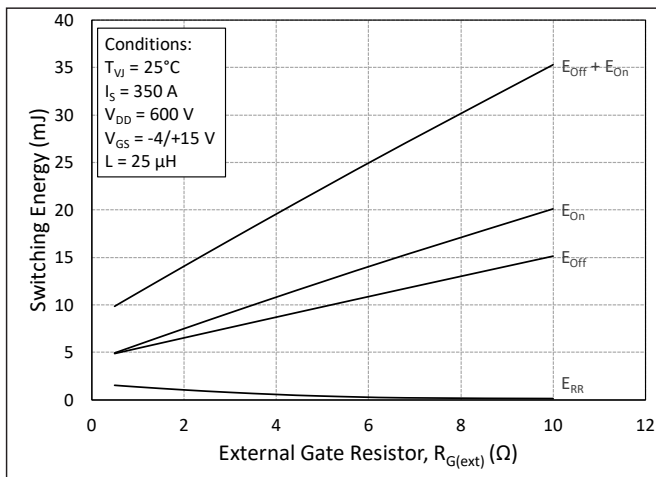

Figure 15. MOSFET Switching Energy vs. External Gate Resistance

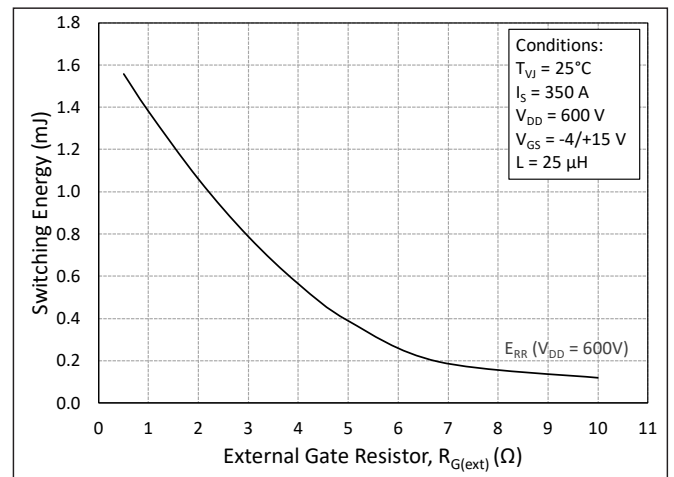

Figure 16. Reverse Recovery Energy vs. External Gate Resistance

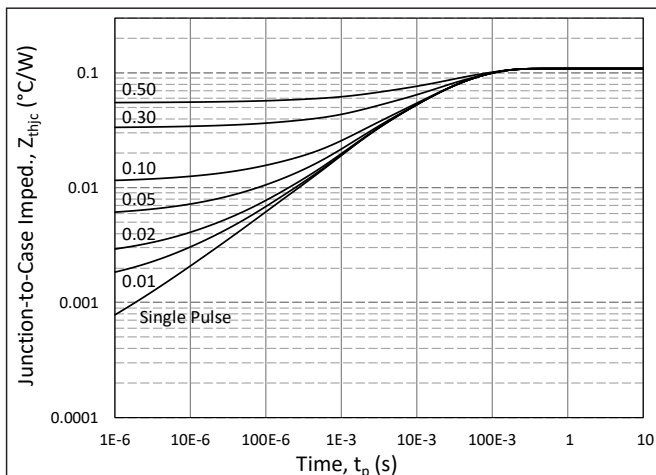

Figure 17. MOSFET Junction to Case Transient Thermal Impedance, $Z_{th(jc)}$ (°C/W)

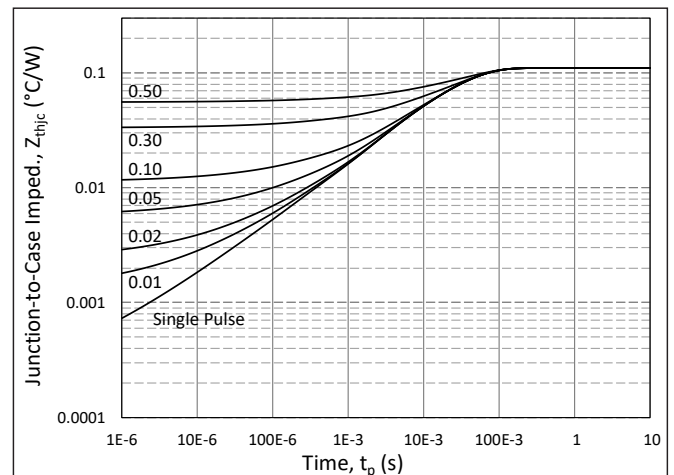

Figure 18. Diode Junction to Case Transient Thermal Impedance, $Z_{th(jc)}$ (°C/W)



Typical Performance

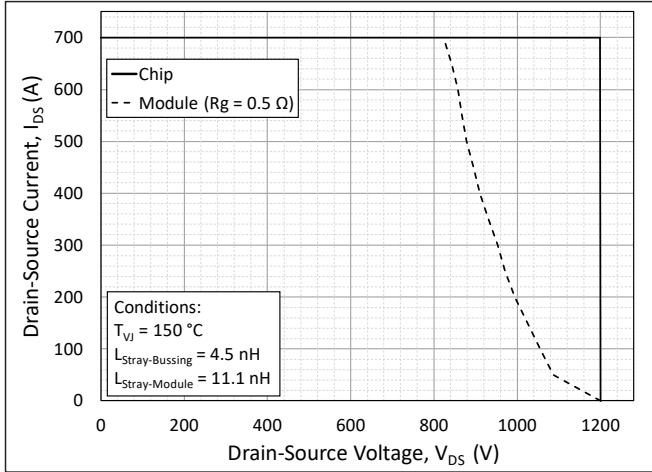

Figure 19. Switching Safe Operating Area

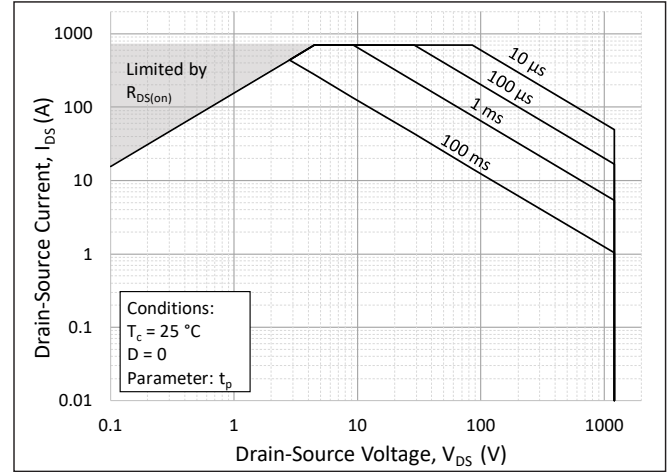

Figure 20. Forward Bias Safe Operating Area (FBSOA)

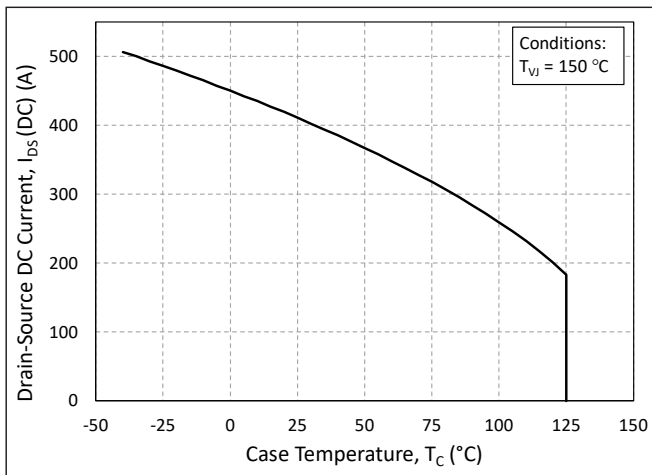

Figure 21. Continuous Drain Current Derating vs. Case Temperature

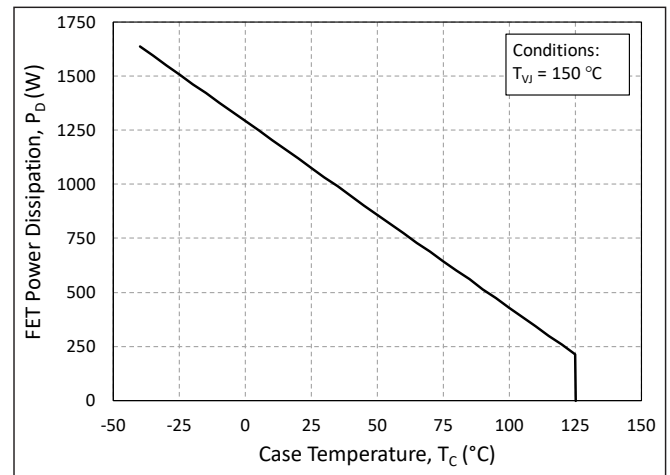

Figure 22. Maximum Power Dissipation Derating vs. Case Temperature

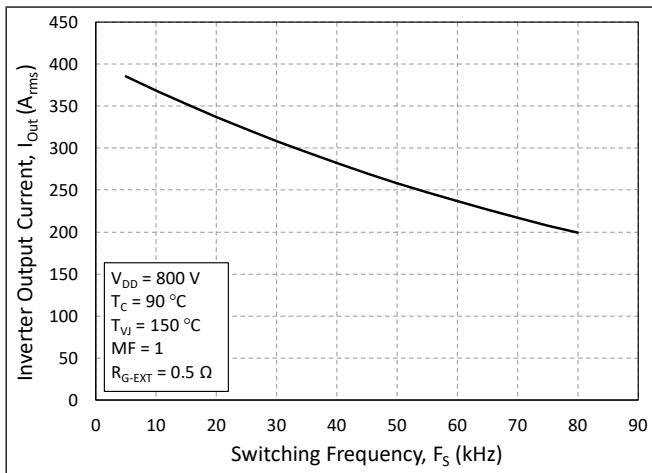

Figure 23. Typical Output Current Capability vs. Switching Frequency (Inverter Application)

Timing Characteristics

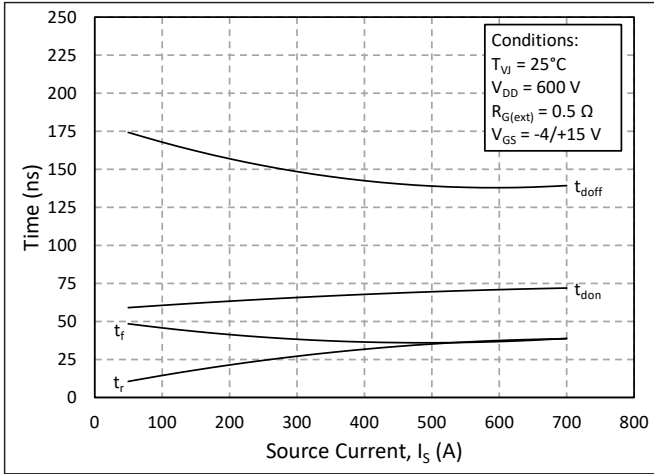

Figure 24. Timing vs. Source Current

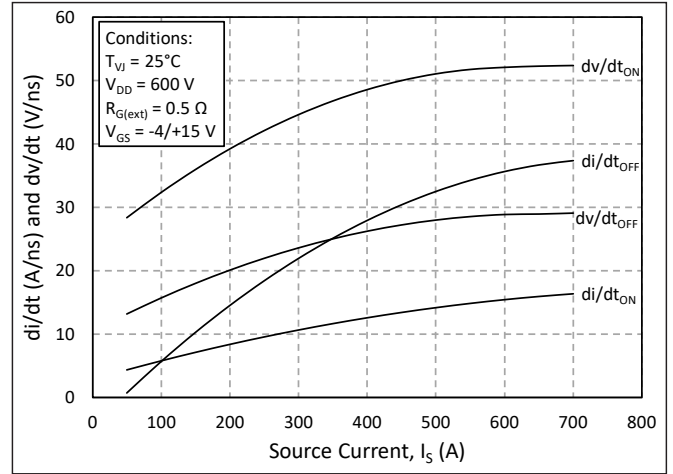

Figure 25. dv/dt and di/dt vs. Source Current

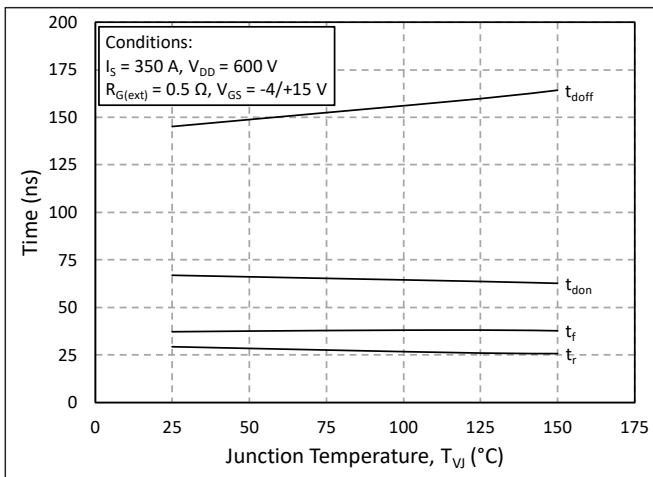

Figure 26. Timing vs. Junction Temperature

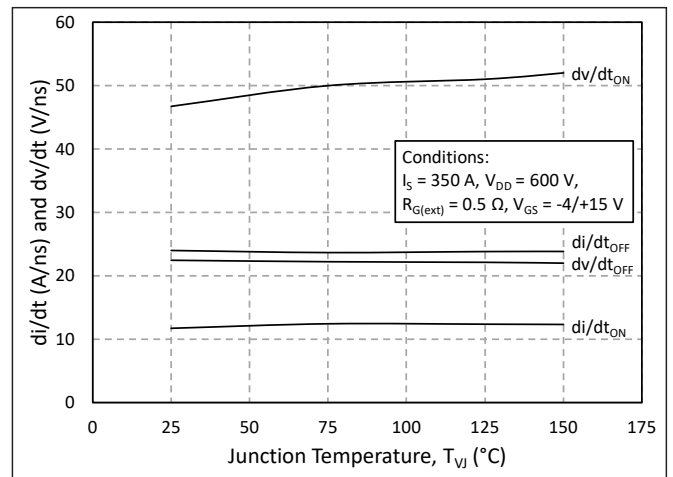

Figure 27. dv/dt and di/dt vs. Junction Temperature

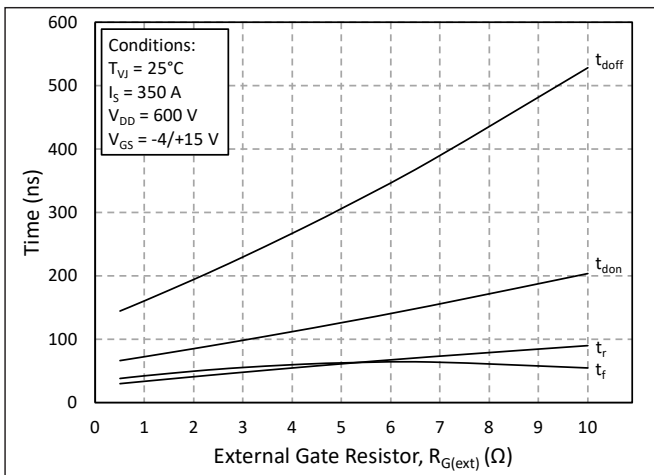

Figure 28. Timing vs. External Gate Resistance

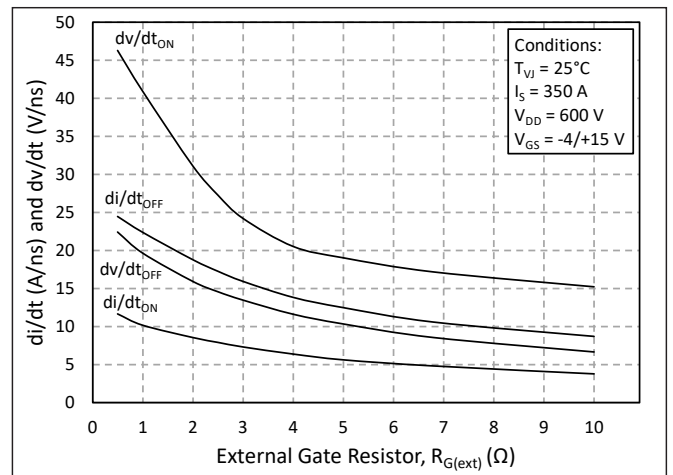

Figure 29. dv/dt and di/dt vs. External Gate Resistance



Definitions

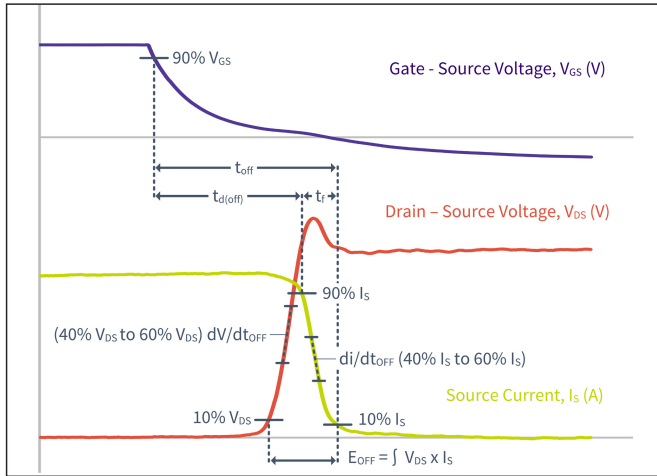

Figure 30. Turn-off Transient Definitions

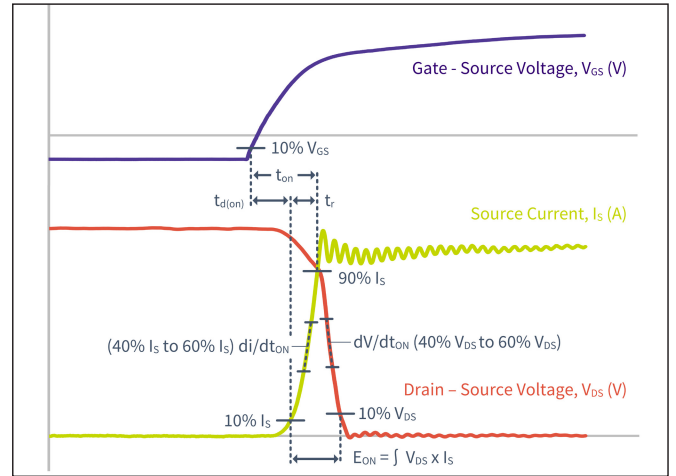

Figure 31. Turn-on Transient Definitions

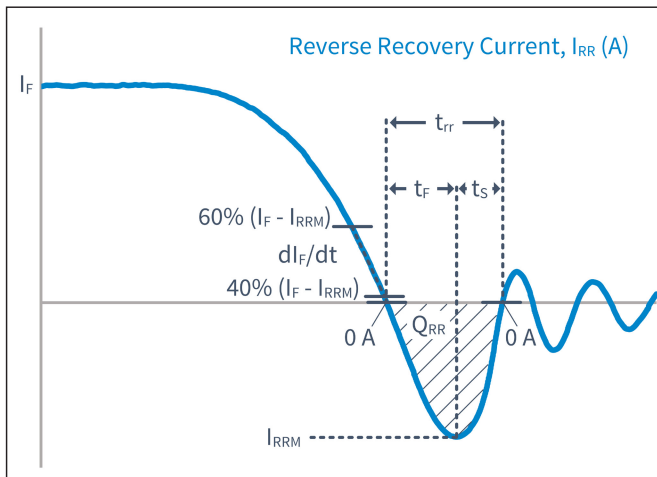

Figure 32. Reverse Recovery Definitions

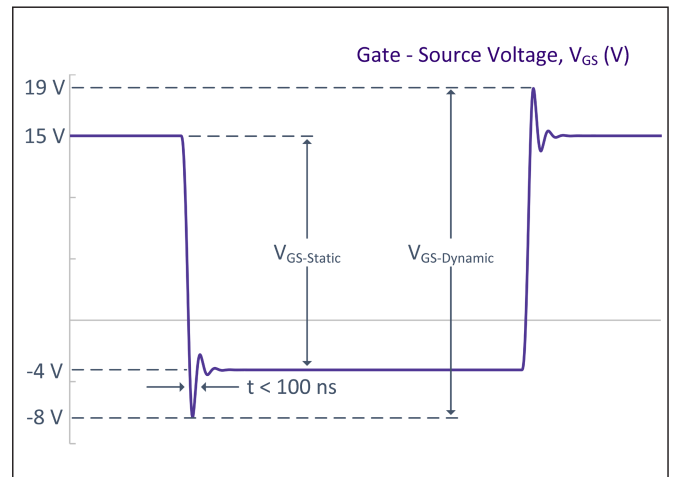
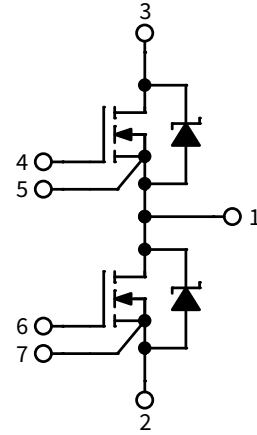
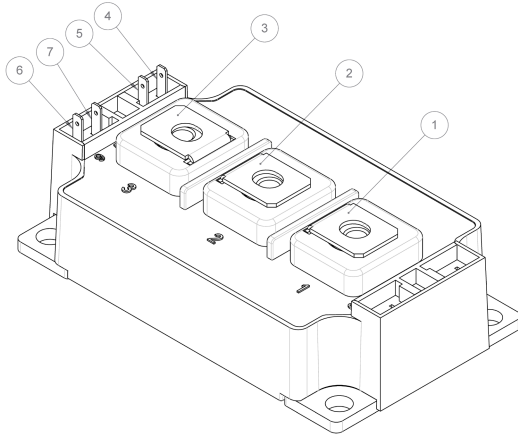

Figure 33. V_{GS} Transient Definitions



Schematic and Pin Out



Package Dimension (mm)

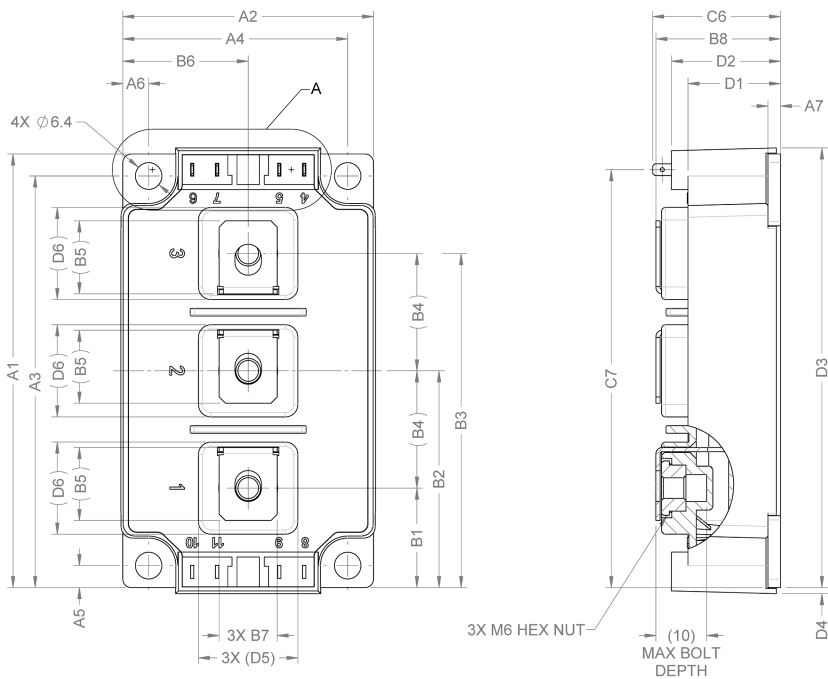

DIMENSION TABLE		
SYMBOL	DIMENSION	TOLERANCE
A1	103.5	±0.30
A2	60.44	±0.30
A3	98.25	±0.30
A4	54.22	±0.30
A5	5.25	±0.30
A6	6.22	±0.30
A7	3	±0.30
B1	23.75	±0.40
B2	51.75	±0.40
B3	79.75	±0.40
B4	(28)	REF.
B5	(17.43)	REF.
B6	30.23	±0.40
B7	(14)	REF.
B8	30.03	±0.40
C1	16.73	±0.40
C2	22.73	±0.40
C3	37.73	±0.40
C4	43.73	±0.40
C5	2.8	±0.40
C6	30.8	±0.50
C7	99.75	±0.40
C8	(6)	REF.
C9	(15)	REF.
D1	22.3	±0.30
D2	26.3	±0.30
D3	104.95	±0.30
D4	1.45	±0.40
D5	(24)	REF.
D6	(22)	REF.

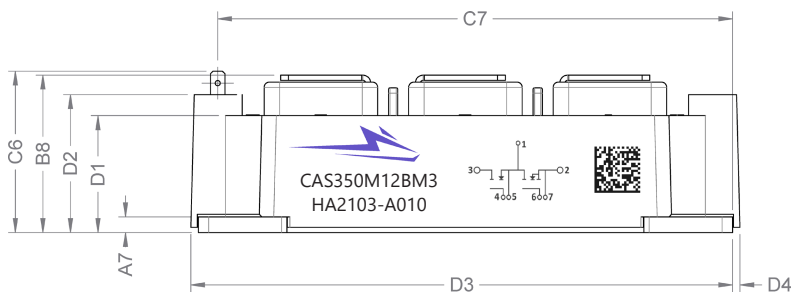



Supporting Links & Tools

Evaluation Tools & Support

- [CAS350M12BM3 PLECS Model](#)
- [KIT-CRD-CIL12N-BM: Dynamic Performance Evaluation Board for the BM2 and BM3 Module](#)
- [SpeedFit 2.0 Design Simulator™](#)
- [Technical Support Forum](#)

Dual-Channel Gate Driver Board

- [CGD1200HB2P-BM3: Dual Channel Differential Isolated Half Bridge Gate Driver Board](#)
- [CGD12HB00D: Differential Transceiver Daughter Board Companion Tool for Differential Gate Drivers](#)

Application Notes

- [CPWR-AN35: 62mm Module Thermal Interface Material Application Note](#)
- [CPWR-AN34: 62mm Module Mounting Guide Application Note](#)
- [CPWRAN12: Understanding the Effects of Parasitic Inductance Part 1.](#)
- [CPWRAN13: Understanding the Effects of Parasitic Inductance Part 2.](#)



Notes & Disclaimer

This document and the information contained herein are subject to change without notice. Any such change shall be evidenced by the publication of an updated version of this document by Cree. No communication from any employee or agent of Cree or any third party shall effect an amendment or modification of this document. No responsibility is assumed by Cree for any infringement of patents or other rights of third parties which may result from use of the information contained herein. No license is granted by implication or otherwise under any patent or patent rights of Cree.

Notwithstanding any application-specific information, guidance, assistance, or support that Cree may provide, the buyer of this product is solely responsible for determining the suitability of this product for the buyer's purposes, including without limitation for use in the applications identified in the next bullet point, and for the compliance of the buyers' products, including those that incorporate this product, with all applicable legal, regulatory, and safety-related requirements.

This product has not been designed or tested for use in, and is not intended for use in, applications in which failure of the product would reasonably be expected to cause death, personal injury, or property damage, including but not limited to equipment implanted into the human body, life-support machines, cardiac defibrillators, and similar emergency medical equipment, aircraft navigation, communication, and control systems, aircraft power and propulsion systems, air traffic control systems, and equipment used in the planning, construction, maintenance, or operation of nuclear facilities.

RoHS Compliance

The levels of RoHS restricted materials in this product are below the maximum concentration values (also referred to as the threshold limits) permitted for such substances, or are used in an exempted application, in accordance with EU Directive 2011/65/EC (RoHS2), as implemented January 2, 2013. RoHS Declarations for this product can be obtained from your Cree representative or from the Product Documentation sections of www.cree.com.

REACH Compliance

REACH substances of high concern (SVHCs) information is available for this product. Since the European Chemical Agency (ECHA) has published notice of their intent to frequently revise the SVHC listing for the foreseeable future, please contact your Cree representative to ensure you get the most up-to-date REACH SVHC Declaration. REACH banned substance information (REACH Article 67) is also available upon request.

Contact info:

4600 Silicon Drive
Durham, NC 27703 USA
Tel: +1.919.313.5300
www.wolfspeed.com/power

Mouser Electronics

Authorized Distributor

Click to View Pricing, Inventory, Delivery & Lifecycle Information:

[Wolfspeed:](#)

[CAS350M12BM3](#)