

CMF20120D-Silicon Carbide Power MOSFET

Z-FET™ MOSFET

N-Channel Enhancement Mode

V_{DS}	1200 V
$I_{D(MAX)}$	42 A
$R_{DS(on)}$	80mΩ

Features

- High Speed Switching with Low Capacitances
- High Blocking Voltage with Low $R_{DS(on)}$
- Easy to Parallel and Simple to Drive
- Avalanche Ruggedness
- Resistant to Latch-Up
- Halogen Free, RoHS Compliant

Benefits

- Higher System Efficiency
- Reduced Cooling Requirements
- Increased System Switching Frequency

Applications

- Solar Inverters
- High Voltage DC/DC Converters
- Motor Drives
- Switch Mode Power Supplies
- UPS

Package

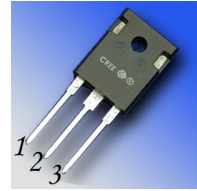

TO-247-3

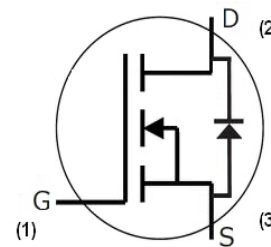

Part Number	Package
CMF20120D	TO-247-3

Maximum Ratings ($T_c = 25^\circ\text{C}$ unless otherwise specified)

Symbol	Parameter	Value	Unit	Test Conditions	Note
I_D	Continuous Drain Current	42	A	$V_{GS@20V}$, $T_C = 25^\circ\text{C}$	Fig. 10
		24		$V_{GS@20V}$, $T_C = 100^\circ\text{C}$	
I_{Dpulse}	Pulsed Drain Current	90	A	Pulse width t_p limited by T_{jmax} $T_C = 25^\circ\text{C}$	
E_{AS}	Single Pulse Avalanche Energy	2.2	J	$I_D = 20A$, $V_{DD} = 50 V$, $L = 9.5 mH$	Fig. 15
E_{AR}	Repetitive Avalanche Energy	1.5	J	t_{AR} limited by T_{jmax}	
I_{AR}	Repetitive Avalanche Current	20	A	$I_D = 20A$, $V_{DD} = 50 V$, $L = 3 mH$ t_{AR} limited by T_{jmax}	
V_{GS}	Gate Source Voltage	-5/+25	V		
P_{tot}	Power Dissipation	215	W	$T_c = 25^\circ\text{C}$	Fig. 9
T_J, T_{stg}	Operating Junction and Storage Temperature	-55 to +135	$^\circ\text{C}$		
T_L	Solder Temperature	260	$^\circ\text{C}$	1.6mm (0.063") from case for 10s	
M_d	Mounting Torque	1	Nm	M3 or 6-32 screw	
		8.8			



Electrical Characteristics (T_C = 25°C unless otherwise specified)

Symbol	Parameter	Min.	Typ.	Max.	Unit	Test Conditions	Note
V _{(BR)DSS}	Drain-Source Breakdown Voltage	1200			V	V _{GS} = 0V, I _D = 100μA	
V _{GS(th)}	Gate Threshold Voltage		2.65	4	V	V _{DS} = V _{GS} , I _D = 1mA	Fig. 11
			3.2	4.8		V _{DS} = V _{GS} , I _D = 10mA	
			2.0		V	V _{DS} = V _{GS} , I _D = 1mA, T _J = 135°C	
			2.45			V _{DS} = V _{GS} , I _D = 10mA, T _J = 135°C	
I _{DSS}	Zero Gate Voltage Drain Current		1	100	μA	V _{DS} = 1200V, V _{GS} = 0V	
			10	250		V _{DS} = 1200V, V _{GS} = 0V, T _J = 135°C	
I _{GSS}	Gate-Source Leakage Current			0.25	μA	V _{GS} = 20V, V _{DS} = 0V	
R _{DS(on)}	Drain-Source On-State Resistance		80	100	mΩ	V _{GS} = 20V, I _D = 20A	Fig. 3
			95	120		V _{GS} = 20V, I _D = 20A, T _J = 135°C	
g _{fs}	Transconductance		7.9		S	V _{DS} = 20V, I _{DS} = 20A	Fig. 6
			7.4			V _{DS} = 20V, I _{DS} = 20A, T _J = 135°C	
C _{iss}	Input Capacitance		1915		pF	V _{GS} = 0V	Fig. 13
C _{oss}	Output Capacitance		120			V _{DS} = 800V	
C _{rss}	Reverse Transfer Capacitance		13			f = 1MHz	
E _{oss}	C _{oss} Stored Energy		62		μJ	V _{AC} = 25mV	Fig. 14
t _{d(on)v}	Turn-On Delay Time		13		ns	V _{DD} = 800V, V _{GS} = 0/20V	Fig. 17
t _{fv}	Fall Time		24			I _D = 20A	
t _{d(off)v}	Turn-Off Delay Time		40			R _{G(ext)} = 2.5Ω, R _L = 40Ω	
t _{rv}	Rise Time		38			Timing relative to V _{DS}	
R _G	Internal Gate Resistance		5		Ω	f = 1MHz, V _{AC} = 25mV	

Built-in SiC Body Diode Characteristics

Symbol	Parameter	Typ.	Max.	Unit	Test Conditions	Note
V _{SD}	Diode Forward Voltage	3.5		V	V _{GS} = -5V, I _F = 10A, T _J = 25°C	
		3.1			V _{GS} = -2V, I _F = 10A, T _J = 25°C	
t _{rr}	Reverse Recovery Time	220		ns	V _{GS} = -5V, I _F = 20A, T _J = 25°C	Fig. 22
Q _{rr}	Reverse Recovery Charge	142		nC	V _R = 800V,	
I _{rrm}	Peak Reverse Recovery Current	2.3		A	di _F /dt = 100A/μs	

Thermal Characteristics

Symbol	Parameter	Typ.	Max.	Unit	Test Conditions	Note
R _{θJC}	Thermal Resistance from Junction to Case	0.44	0.51	K/W		Fig. 7
R _{θCS}	Case to Sink, w/ Thermal Compound	0.25				
R _{θJA}	Thermal Resistance From Junction to Ambient		40			

Gate Charge Characteristics

Symbol	Parameter	Typ.	Max.	Unit	Test Conditions	Note
Q _{gs}	Gate to Source Charge	23.8		nC	V _{DD} = 800V, V _{GS} = 0/20V I _D = 20A Per JEDEC24 pg 27	Fig. 12
Q _{gd}	Gate to Drain Charge	43.1				
Q _g	Gate Charge Total	90.8				

Typical Performance

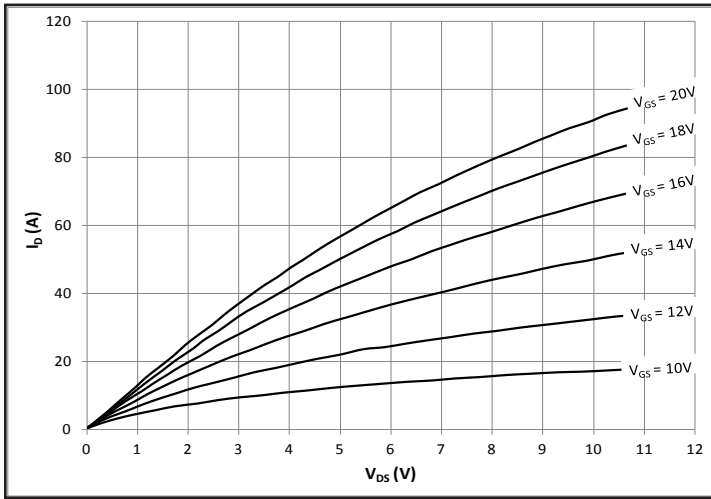

Figure 1. Typical Output Characteristics $T_j = 25^\circ\text{C}$

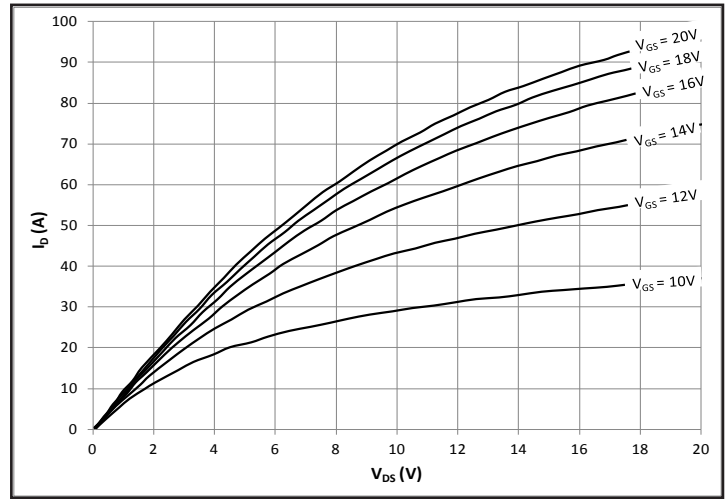

Figure 2. Typical Output Characteristics $T_j = 135^\circ\text{C}$

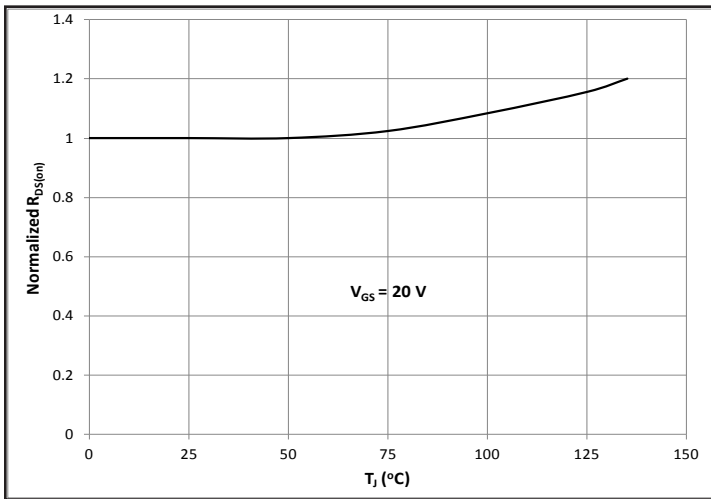

Figure 3. Normalized On-Resistance vs. Temperature

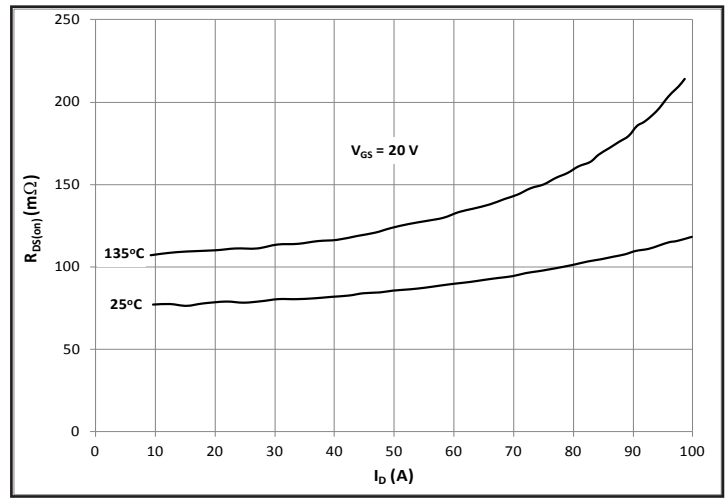

Figure 4. On-Resistance vs. Drain Current

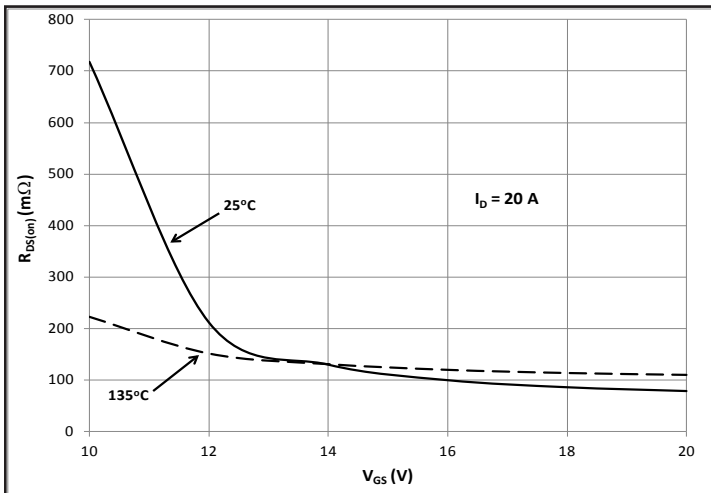

Figure 5. On-Resistance vs. Gate Voltage

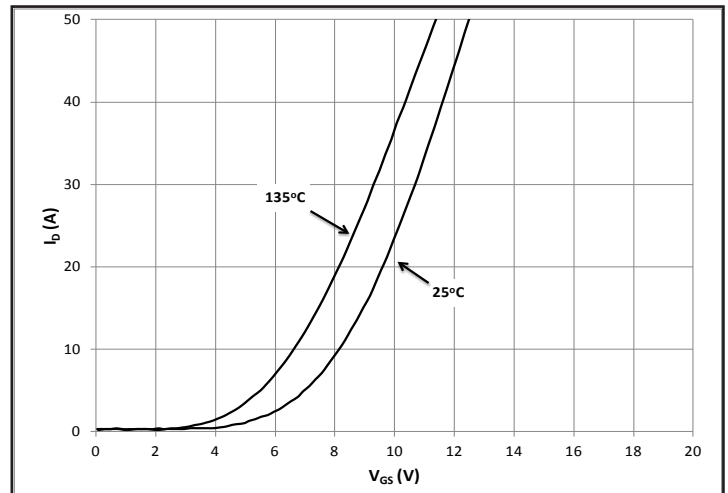

Figure 6. Typical Transfer Characteristics

Typical Performance

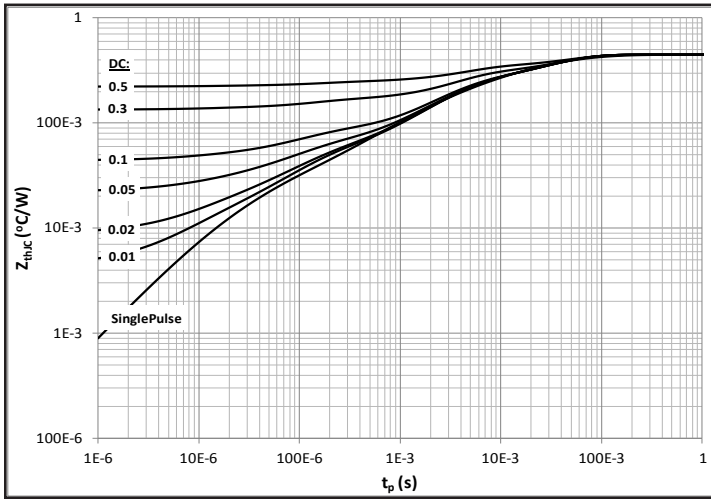

Figure 7. Transient Thermal Impedance (Junction - Case) with Duty Cycle

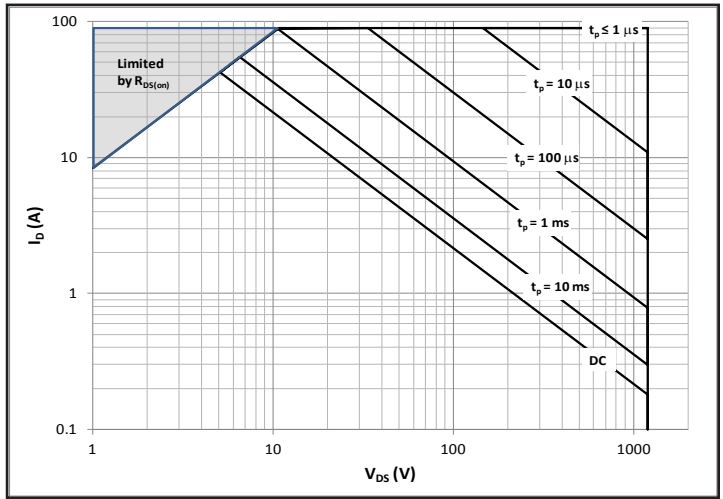

Figure 8. Safe Operating Area

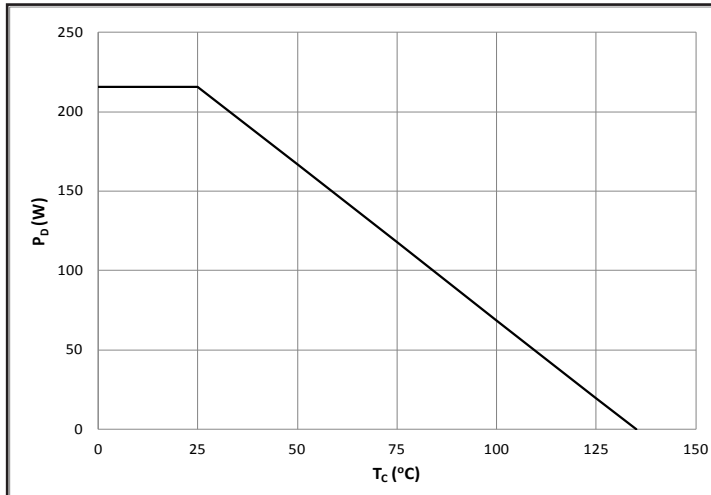

Figure 9. Power Dissipation Derating Curve

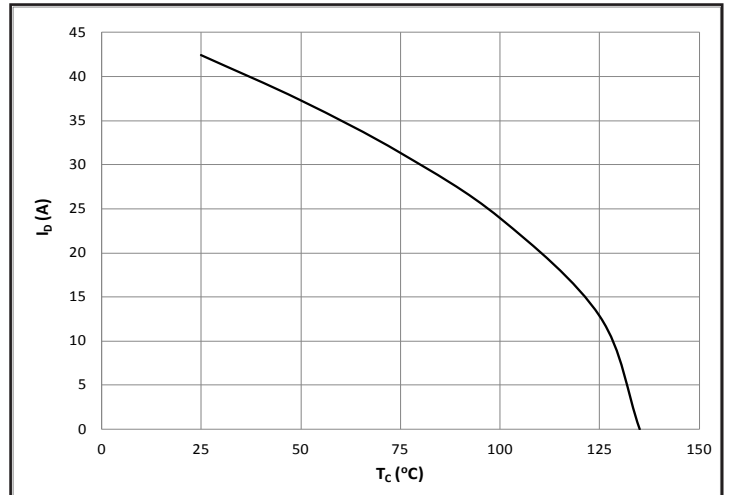

Figure 10. Continuous Current Derating Curve

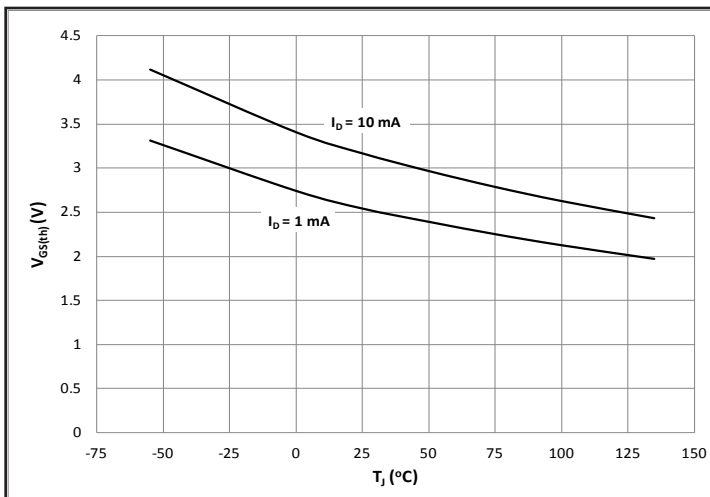

Figure 11. Gate Threshold Voltage vs. Temperature

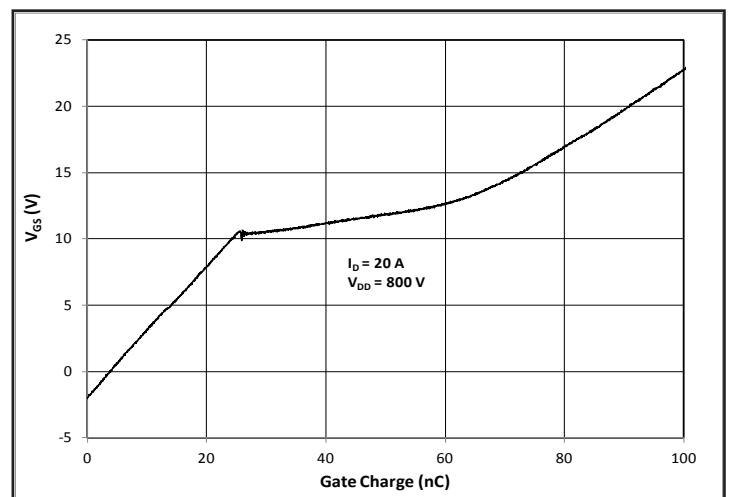

Figure 12. Typical Gate Charge Characteristics (25°C)

Typical Performance

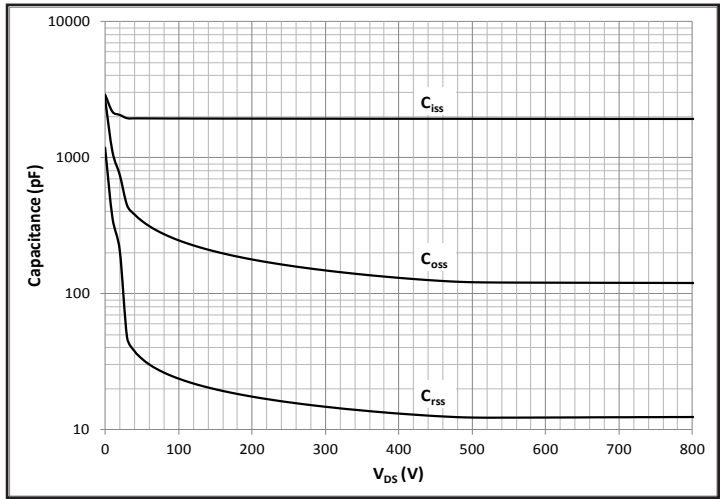
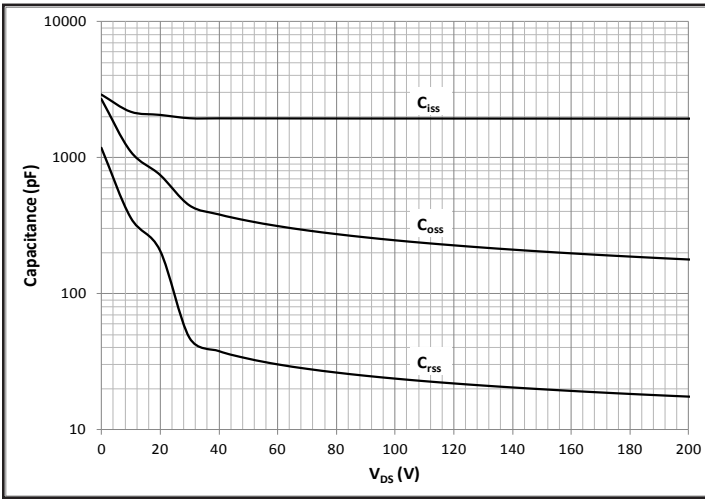

Figure 13A and 13B. Typical Capacitances vs. Drain Voltage at $V_{GS} = 0V$ and $f = 1\text{ MHz}$

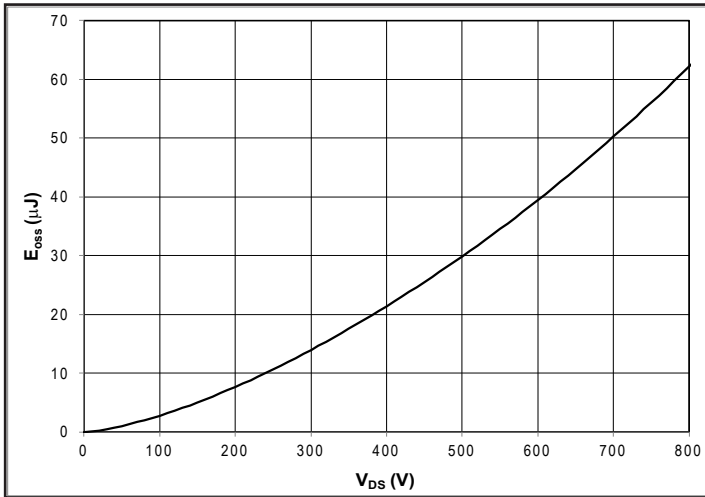

Figure 14. Typical C_{OSS} Stored Energy

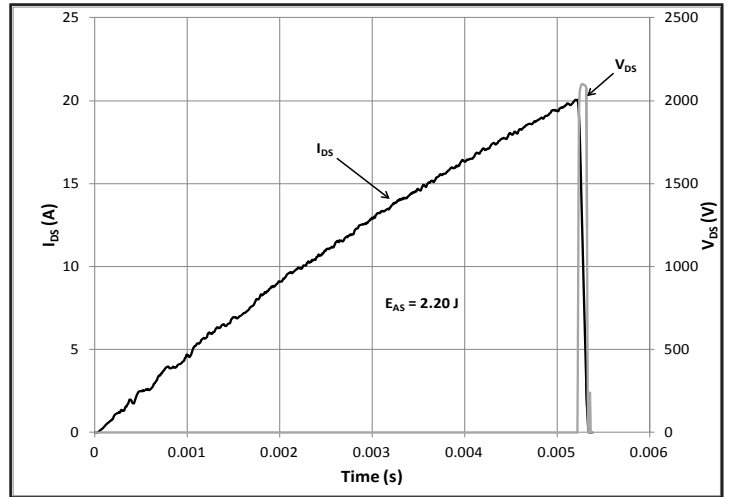

Figure 15. Typical Unclamped Inductive Switching Waveforms Showing Avalanche Capability

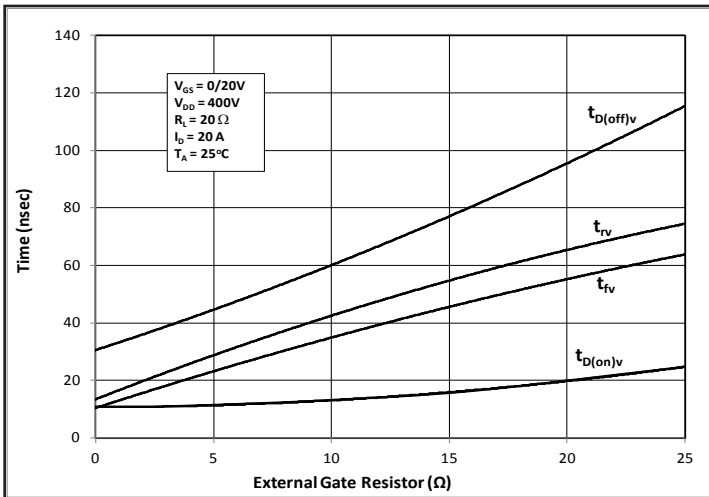

Figure 16. Resistive Switching Times vs. External R_G at $V_{DD} = 400V$, $I_D = 20A$

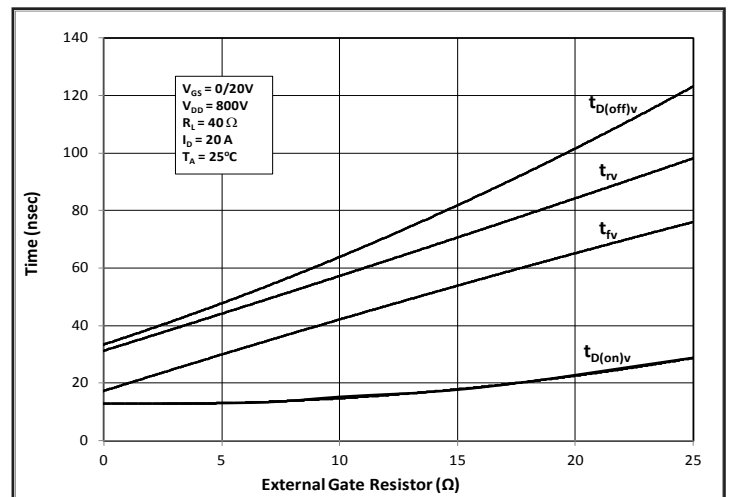

Figure 17. Resistive Switching Times vs. External R_G at $V_{DD} = 800V$, $I_D = 20A$

Typical Performance

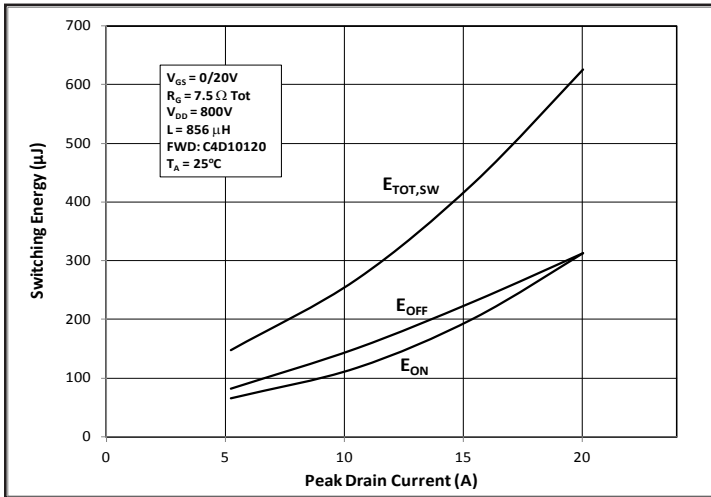

Figure 18. Clamped Inductive Switching Energy vs. Drain Current (Fig. 20)

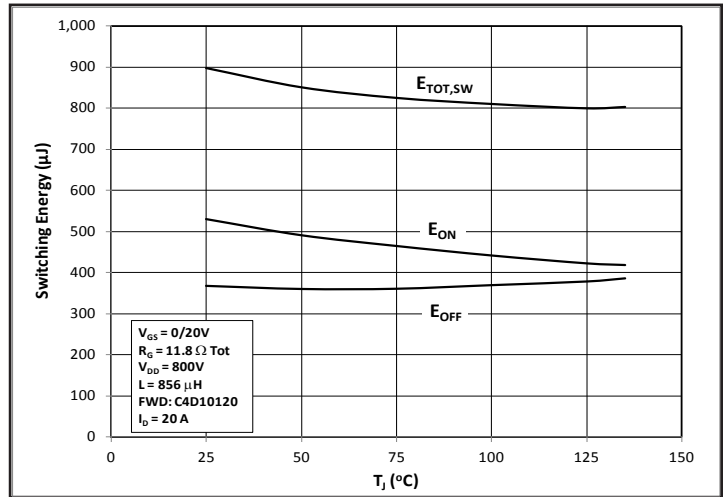

Figure 19. Clamped Inductive Switching Energy vs. Junction Temperature (Fig. 20)

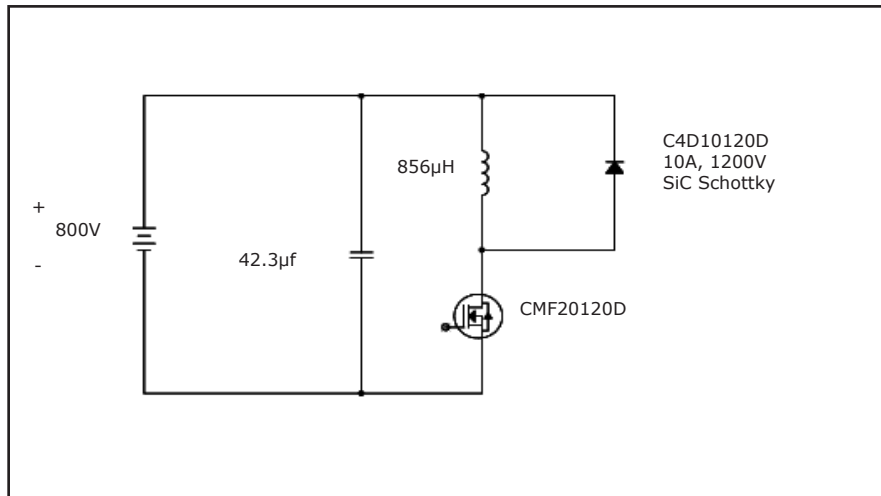

Figure 20. Clamped Inductive Switching Waveform Test Circuit

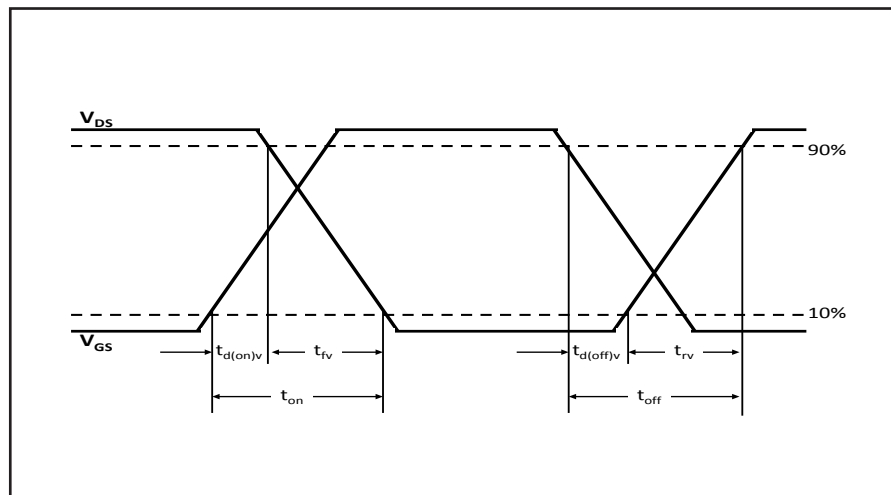

Figure 21. Switching Test Waveforms for Transition times

Test Circuit Diagrams and Waveforms

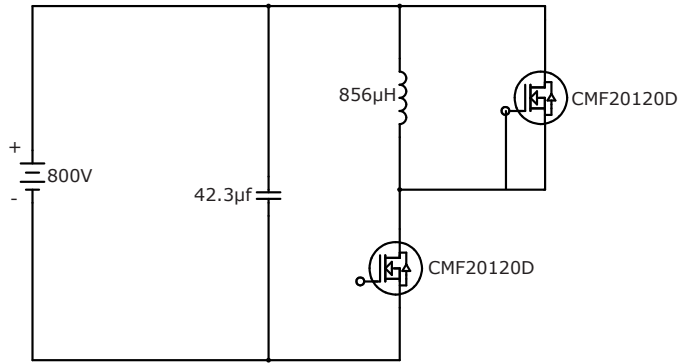

Fig 22. Body Diode Recovery Test

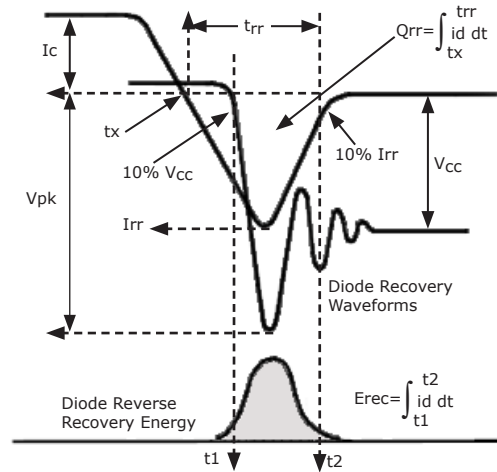

Fig 23. Body Diode Recovery Waveform

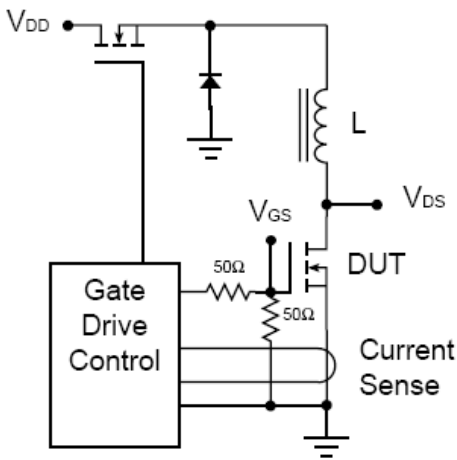

Fig 24. Unclamped Inductive Switching Test Circuit

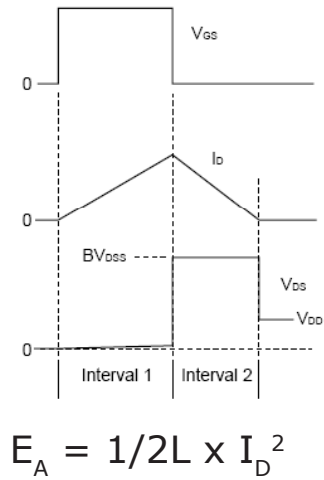

Fig 25. Unclamped Inductive Switching waveform for Avalanche Energy

ESD Ratings

ESD Test	Total Devices Sampled	Resulting Classification
ESD-HBM	All Devices Passed 1000V	2 (>2000V)
ESD-MM	All Devices Passed 400V	C (>400V)
ESD-CDM	All Devices Passed 1000V	IV (>1000V)

Package Dimensions

Package TO-247-3

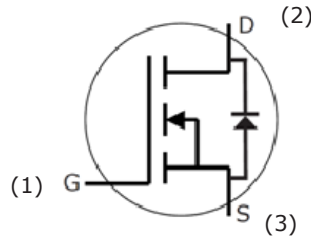
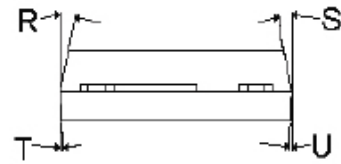
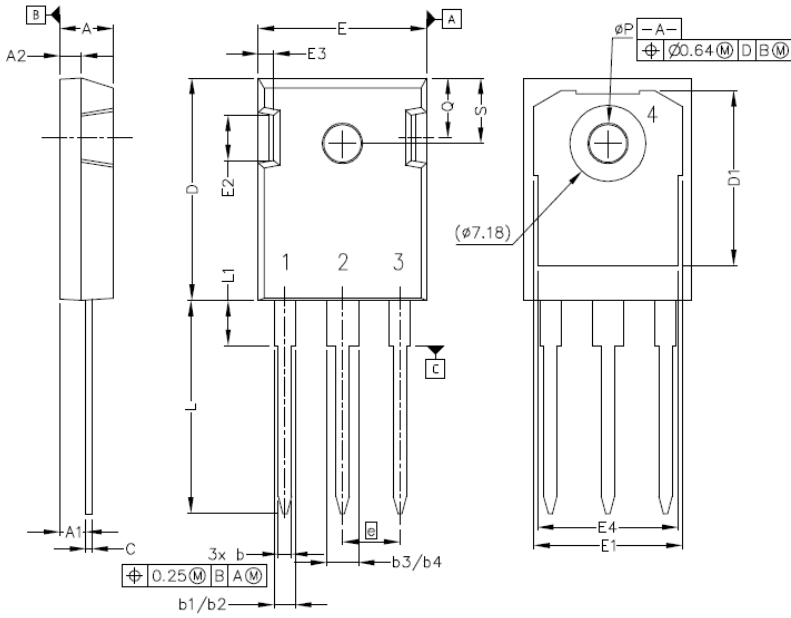

POS	Inches		Millimeters	
	Min	Max	Min	Max
A	.190	.205	4.83	5.21
A1	.090	.100	2.29	2.54
A2	.075	.085	1.91	2.16
b	.042	.052	1.07	1.33
b1	.075	.095	1.91	2.41
b2	.075	.085	1.91	2.16
b3	.113	.133	2.87	3.38
b4	.113	.123	2.87	3.13
c	.022	.027	0.55	0.68
D	.819	.831	20.80	21.10
D1	.640	.695	16.25	17.65
D2	.037	.049	0.95	1.25
E	.620	.635	15.75	16.13
E1	.516	.557	13.10	14.15
E2	.145	.201	3.68	5.10
E3	.039	.075	1.00	1.90
E4	.487	.529	12.38	13.43
e	.214 BSC		5.44 BSC	
N	3		3	
L	.780	.800	19.81	20.32
L1	.161	.173	4.10	4.40
ØP	.138	.144	3.51	3.65
Q	.216	.236	5.49	6.00
S	.238	.248	6.04	6.30

Recommended Solder Pad Layout

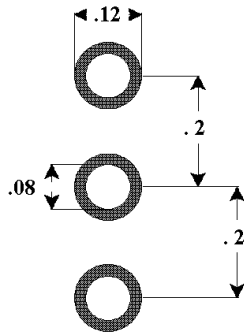

TO-247-3

Part Number	Package	Marking
CMF20120D	TO-247-3	CMF20120

This product has not been designed or tested for use in, and is not intended for use in, applications implanted into the human body nor in applications in which failure of the product could lead to death, personal injury or property damage, including but not limited to equipment used in the operation of nuclear facilities, life-support machines, cardiac defibrillators or similar emergency medical equipment, aircraft navigation or communication or control systems, air traffic control systems, or weapons systems.

Copyright © 2012 Cree, Inc. All rights reserved. The information in this document is subject to change without notice. Cree and the Cree logo are registered trademarks and Z-REC and Z-FET are trademarks of Cree, Inc.

Cree, Inc.
4600 Silicon Drive
Durham, NC 27703
USA Tel: +1.919.313.5300
Fax: +1.919.313.5451
www.cree.com/power

Mouser Electronics

Authorized Distributor

Click to View Pricing, Inventory, Delivery & Lifecycle Information:

[Cree, Inc.:](#)

[CMF20120D](#)