

ESP32-S3 Series

Datasheet Version 2.0

Xtensa® 32-bit LX7 dual-core microprocessor
2.4 GHz Wi-Fi (IEEE 802.11b/g/n) and Bluetooth® 5 (LE)
Optional 1.8 V or 3.3 V flash and PSRAM in the chip's package
45 GPIOs
QFN56 (7×7 mm) Package

Including:

ESP32-S3

ESP32-S3FN8

ESP32-S3R2

ESP32-S3R8

ESP32-S3R8V – [End of Life \(EOL\)](#)

ESP32-S3R16V

ESP32-S3FH4R2



Product Overview

ESP32-S3 is a low-power MCU-based system on a chip (SoC) with integrated 2.4 GHz Wi-Fi and Bluetooth® Low Energy (Bluetooth LE). It consists of high-performance dual-core microprocessor (Xtensa® 32-bit LX7), a ULP coprocessor, a Wi-Fi baseband, a Bluetooth LE baseband, RF module, and numerous peripherals.

The functional block diagram of the SoC is shown below.

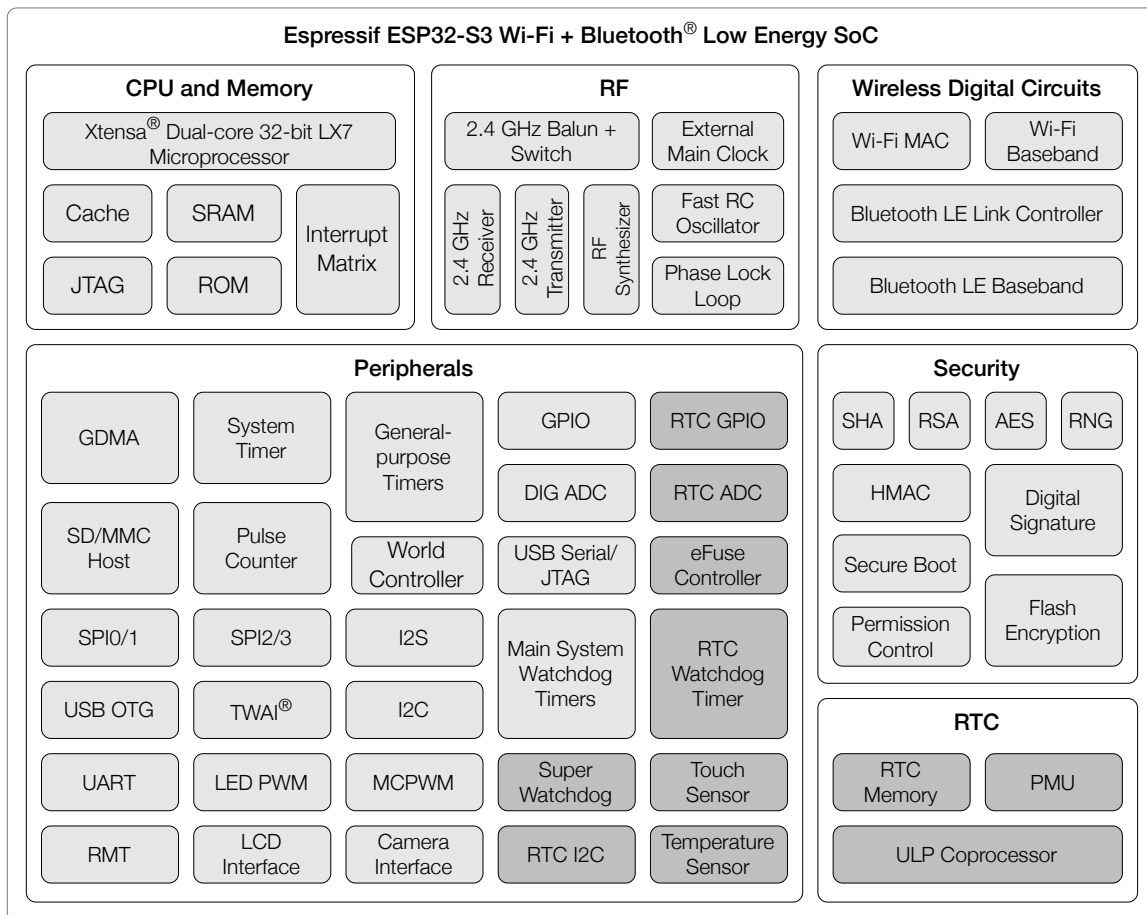

Power consumption

-  Normal
-  Low power consumption components capable of working in Deep-sleep mode

ESP32-S3 Functional Block Diagram

For more information on power consumption, see Section [4.1.3.5 Power Management Unit \(PMU\)](#).

Features

Wi-Fi

- IEEE 802.11b/g/n-compliant
- Supports 20 MHz and 40 MHz bandwidth in 2.4 GHz band
- 1T1R mode with data rate up to 150 Mbps
- Wi-Fi Multimedia (WMM)
- TX/RX A-MPDU, TX/RX A-MSDU
- Immediate Block ACK
- Fragmentation and defragmentation
- Automatic Beacon monitoring (hardware TSF)
- Four virtual Wi-Fi interfaces
- Simultaneous support for Infrastructure BSS in Station, SoftAP, or Station + SoftAP modes
Note that when ESP32-S3 scans in Station mode, the SoftAP channel will change along with the Station channel
- Antenna diversity
- 802.11mc FTM

Bluetooth

- Bluetooth LE: Bluetooth 5, Bluetooth mesh
- High power mode (20 dBm)
- Speed: 125 Kbps, 500 Kbps, 1 Mbps, 2 Mbps
- Advertising extensions
- Multiple advertisement sets
- Channel selection algorithm #2
- Internal co-existence mechanism between Wi-Fi and Bluetooth to share the same antenna

CPU and Memory

- Xtensa® dual-core 32-bit LX7 microprocessor
- Clock speed: up to 240 MHz
- CoreMark® score:
 - Two cores at 240 MHz: 1329.92 CoreMark; 5.54 CoreMark/MHz
- Five-stage pipeline
- 128-bit data bus and dedicated SIMD instructions
- Single precision floating point unit (FPU)

- L1 cache
- ROM: 384 KB
- SRAM: 512 KB
- SRAM in RTC: 16 KB
- Supported SPI protocols: SPI, Dual SPI, Quad SPI, Octal SPI, QPI and OPI interfaces that allow connection to flash, external RAM, and other SPI devices
- Flash controller with cache is supported
- Flash in-Circuit Programming (ICP) is supported

Advanced Peripheral Interfaces

- 45 programmable GPIOs
 - 4 strapping GPIOs
 - 6 or 7 GPIOs needed for in-package flash or PSRAM
 - * ESP32-S3FN8, ESP32-S3R2, ESP32-S3R8, ESP32-S3R8V, ESP32-S3R16V: 6 GPIOs needed
 - * ESP32-S3FH4R2: 7 GPIOs needed
- Digital interfaces:
 - Two SPI ports for communication with flash and RAM
 - Two general-purpose SPI ports
 - LCD interface (8-bit ~ 16-bit parallel RGB, I8080 and MOTO6800), supporting conversion between RGB565, YUV422, YUV420 and YUV411
 - DVP 8-bit ~ 16-bit camera interface
 - Three UARTs
 - Two I2Cs
 - Two I2Ss
 - RMT (TX/RX)
 - Pulse counter
 - LED PWM controller, up to 8 channels
 - Full-speed USB OTG
 - USB Serial/JTAG controller
 - Two Motor Control PWMs (MCPWM)
 - SD/MMC host controller with 2 slots
 - General DMA controller (GDMA), with 5 transmit channels and 5 receive channels
 - TWAI® controller, compatible with ISO 11898-1 (CAN Specification 2.0)
 - On-chip debug functionality via JTAG

- Analog interfaces:
 - Two 12-bit SAR ADCs, up to 20 channels
 - Temperature sensor
 - 14 touch sensing IOs
- Timers:
 - Four 54-bit general-purpose timers
 - 52-bit system timer
 - Three watchdog timers

Low Power Management

- Fine-resolution power control through a selection of clock frequency, duty cycle, Wi-Fi operating modes, and individual power control of internal components
- Four power modes designed for typical scenarios: Active, Modem-sleep, Light-sleep, Deep-sleep
- Power consumption in Deep-sleep mode is as low as 7 μ A
- Ultra-Low-Power (ULP) coprocessors:
 - ULP-RISC-V coprocessor
 - ULP-FSM coprocessor
- RTC memory remains powered on in Deep-sleep mode

Security

- Secure boot
- Flash encryption
- 4-Kbit OTP, up to 1792 bits for users
- Cryptographic hardware acceleration:
 - AES-128/256 (FIPS PUB 197)
 - SHA (FIPS PUB 180-4)
 - RSA
 - Random Number Generator (RNG)
 - HMAC
 - Digital signature

Applications

With low power consumption, ESP32-S3 is an ideal choice for IoT devices in the following areas:

- Smart Home
- Industrial Automation
- Health Care
- Consumer Electronics
- Smart Agriculture
- POS machines
- Service robot
- Audio Devices
- Generic Low-power IoT Sensor Hubs
- Generic Low-power IoT Data Loggers
- Cameras for Video Streaming
- USB Devices
- Speech Recognition
- Image Recognition
- Wi-Fi + Bluetooth Networking Card
- Touch and Proximity Sensing

Note:

Check the link or the QR code to make sure that you use the latest version of this document:
https://www.espressif.com/documentation/esp32-s3_datasheet_en.pdf



Contents

Product Overview	2
Features	3
Applications	5
1 ESP32-S3 Series Comparison	13
1.1 Nomenclature	13
1.2 Comparison	13
2 Pins	14
2.1 Pin Layout	14
2.2 Pin Overview	15
2.3 IO Pins	19
2.3.1 IO MUX Functions	19
2.3.2 RTC Functions	21
2.3.3 Analog Functions	22
2.3.4 Restrictions for GPIOs and RTC_GPIOs	24
2.4 Analog Pins	25
2.5 Power Supply	26
2.5.1 Power Pins	26
2.5.2 Power Scheme	26
2.5.3 Chip Power-up and Reset	27
2.6 Pin Mapping Between Chip and Flash/PSRAM	28
3 Boot Configurations	29
3.1 Chip Boot Mode Control	30
3.2 VDD_SPI Voltage Control	31
3.3 ROM Messages Printing Control	31
3.4 JTAG Signal Source Control	31
4 Functional Description	33
4.1 System	33
4.1.1 Microprocessor and Master	33
4.1.1.1 CPU	33
4.1.1.2 Processor Instruction Extensions (PIE)	33
4.1.1.3 Ultra-Low-Power Coprocessor (ULP)	34
4.1.1.4 GDMA Controller (GDMA)	34

4.1.2	Memory Organization	35
4.1.2.1	Internal Memory	36
4.1.2.2	External Flash and RAM	36
4.1.2.3	Cache	37
4.1.2.4	eFuse Controller	37
4.1.3	System Components	37
4.1.3.1	IO MUX and GPIO Matrix	37
4.1.3.2	Reset	38
4.1.3.3	Clock	39
4.1.3.4	Interrupt Matrix	39
4.1.3.5	Power Management Unit (PMU)	40
4.1.3.6	System Timer	42
4.1.3.7	General Purpose Timers	42
4.1.3.8	Watchdog Timers	42
4.1.3.9	XTAL32K Watchdog Timers	43
4.1.3.10	Permission Control	43
4.1.3.11	World Controller	44
4.1.3.12	System Registers	44
4.1.4	Cryptography and Security Component	45
4.1.4.1	SHA Accelerator	45
4.1.4.2	AES Accelerator	45
4.1.4.3	RSA Accelerator	46
4.1.4.4	Secure Boot	46
4.1.4.5	HMAC Accelerator	46
4.1.4.6	Digital Signature	47
4.1.4.7	External Memory Encryption and Decryption	47
4.1.4.8	Clock Glitch Detection	47
4.1.4.9	Random Number Generator	47
4.2	Peripherals	48
4.2.1	Connectivity Interface	48
4.2.1.1	UART Controller	48
4.2.1.2	I2C Interface	49
4.2.1.3	I2S Interface	49
4.2.1.4	LCD and Camera Controller	50
4.2.1.5	Serial Peripheral Interface (SPI)	50
4.2.1.6	Two-Wire Automotive Interface (TWAI®)	53
4.2.1.7	USB 2.0 OTG Full-Speed Interface	53
4.2.1.8	USB Serial/JTAG Controller	55
4.2.1.9	SD/MMC Host Controller	55
4.2.1.10	LED PWM Controller	56
4.2.1.11	Motor Control PWM (MCPWM)	56
4.2.1.12	Remote Control Peripheral (RMT)	57
4.2.1.13	Pulse Count Controller (PCNT)	57
4.2.2	Analog Signal Processing	58
4.2.2.1	SAR ADC	58
4.2.2.2	Temperature Sensor	59

4.2.2.3	Touch Sensor	59
4.3	Wireless Communication	60
4.3.1	Radio	60
4.3.1.1	2.4 GHz Receiver	60
4.3.1.2	2.4 GHz Transmitter	60
4.3.1.3	Clock Generator	60
4.3.2	Wi-Fi	60
4.3.2.1	Wi-Fi Radio and Baseband	61
4.3.2.2	Wi-Fi MAC	61
4.3.2.3	Networking Features	61
4.3.3	Bluetooth LE	61
4.3.3.1	Bluetooth LE PHY	62
4.3.3.2	Bluetooth LE Link Controller	62
5	Electrical Characteristics	63
5.1	Absolute Maximum Ratings	63
5.2	Recommended Power Supply Characteristics	63
5.3	VDD_SPI Output Characteristics	64
5.4	DC Characteristics (3.3 V, 25 °C)	64
5.5	ADC Characteristics	65
5.6	Current Consumption	65
5.6.1	RF Current Consumption in Active Mode	65
5.6.2	Current Consumption in Other Modes	65
5.7	Reliability	68
6	RF Characteristics	69
6.1	Wi-Fi Radio	69
6.1.1	Wi-Fi RF Transmitter (TX) Specifications	69
6.1.2	Wi-Fi RF Receiver (RX) Specifications	70
6.2	Bluetooth LE Radio	71
6.2.1	Bluetooth LE RF Transmitter (TX) Specifications	71
6.2.2	Bluetooth LE RF Receiver (RX) Specifications	73
7	Packaging	76
	Appendix A – ESP32-S3 Consolidated Pin Overview	78
	Related Documentation and Resources	79
	Revision History	80

List of Tables

1-1	ESP32-S3 Series Comparison	13
2-1	Pin Overview	15
2-2	Power-Up Glitches on Pins	17
2-3	Peripheral Signals Routed via IO MUX	19
2-4	IO MUX Pin Functions	20
2-5	RTC Peripheral Signals Routed via RTC IO MUX	22
2-6	RTC Functions	22
2-7	Analog Signals Routed to Analog Functions	23
2-8	Analog Functions	23
2-9	Analog Pins	25
2-10	Power Pins	26
2-11	Voltage Regulators	26
2-12	Description of Timing Parameters for Power-up and Reset	27
2-13	Pin Mapping Between Chip and In-package Flash/ PSRAM	28
3-1	Default Configuration of Strapping Pins	29
3-2	Description of Timing Parameters for the Strapping Pins	30
3-3	Chip Boot Mode Control	30
3-4	VDD_SPI Voltage Control	31
3-5	JTAG Signal Source Control	32
4-1	Components and Power Domains	41
5-1	Absolute Maximum Ratings	63
5-2	Recommended Power Characteristics	63
5-3	VDD_SPI Internal and Output Characteristics	64
5-4	DC Characteristics (3.3 V, 25 °C)	64
5-5	ADC Characteristics	65
5-6	ADC Calibration Results	65
5-7	Wi-Fi Current Consumption Depending on RF Modes	65
5-8	Current Consumption in Modem-sleep Mode	66
5-9	Current Consumption in Low-Power Modes	66
5-10	Reliability Qualifications	68
6-1	Wi-Fi RF Characteristics	69
6-2	TX Power with Spectral Mask and EVM Meeting 802.11 Standards	69
6-3	TX EVM Test ¹	69
6-4	RX Sensitivity	70
6-5	Maximum RX Level	71
6-6	RX Adjacent Channel Rejection	71
6-7	Bluetooth LE Frequency	71
6-8	Transmitter Characteristics - Bluetooth LE 1 Mbps	71
6-9	Transmitter Characteristics - Bluetooth LE 2 Mbps	72
6-10	Transmitter Characteristics - Bluetooth LE 125 Kbps	72
6-11	Transmitter Characteristics - Bluetooth LE 500 Kbps	73
6-12	Receiver Characteristics - Bluetooth LE 1 Mbps	73
6-13	Receiver Characteristics - Bluetooth LE 2 Mbps	74

6-14 Receiver Characteristics - Bluetooth LE 125 Kbps	74
6-15 Receiver Characteristics - Bluetooth LE 500 Kbps	75

List of Figures

1-1	ESP32-S3 Series Nomenclature	13
2-1	ESP32-S3 Pin Layout (Top View)	14
2-2	ESP32-S3 Power Scheme	27
2-3	Visualization of Timing Parameters for Power-up and Reset	27
3-1	Visualization of Timing Parameters for the Strapping Pins	30
4-1	Address Mapping Structure	35
4-2	Components and Power Domains	41
7-1	QFN56 (7×7 mm) Package	76
7-2	QFN56 (7×7 mm) Package (Only for ESP32-S3FH4R2)	77

1 ESP32-S3 Series Comparison

1.1 Nomenclature

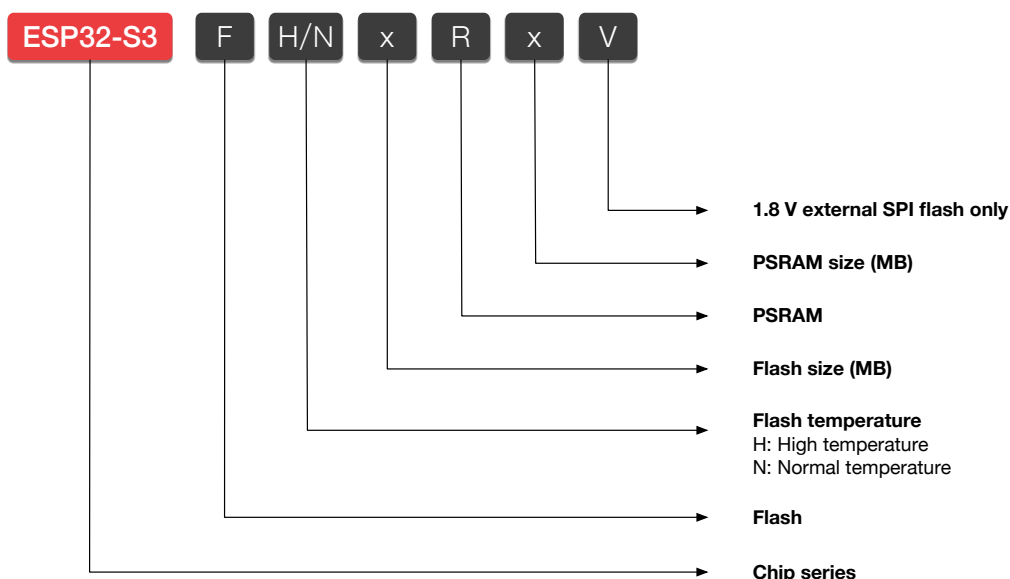

Figure 1-1. ESP32-S3 Series Nomenclature

1.2 Comparison

Table 1-1. ESP32-S3 Series Comparison

Ordering Code ¹	In-Package Flash ²	In-Package PSRAM	Ambient Temp. ³ (°C)	VDD_SPI Voltage ⁴
ESP32-S3	—	—	-40 ~ 105	3.3 V/1.8 V
ESP32-S3FN8	8 MB (Quad SPI) ⁵	—	-40 ~ 85	3.3 V
ESP32-S3R2	—	2 MB (Quad SPI)	-40 ~ 85	3.3 V
ESP32-S3R8	—	8 MB (Octal SPI)	-40 ~ 65	3.3 V
ESP32-S3R8V (End of Life)	—	8 MB (Octal SPI)	-40 ~ 65	1.8 V
ESP32-S3R16V	—	16 MB (Octal SPI)	-40 ~ 65	1.8 V
ESP32-S3FH4R2	4 MB (Quad SPI)	2 MB (Quad SPI)	-40 ~ 85	3.3 V

¹ For details on chip marking and packing, see Section 7 *Packaging*.

² By default, the SPI flash on the chip operates at a maximum clock frequency of 80 MHz and does not support the auto suspend feature. If you have a requirement for a higher flash clock frequency of 120 MHz or if you need the flash auto suspend feature, please [contact us](#).

³ Ambient temperature specifies the recommended temperature range of the environment immediately outside an Espressif chip. For chips with Octal SPI PSRAM (ESP32-S3R8, ESP32-S3R8V, and ESP32-S3R16V), if the PSRAM ECC function is enabled, the maximum ambient temperature can be improved to 85 °C, while the usable size of PSRAM will be reduced by 1/16.

⁴ For more information on VDD_SPI, see Section 2.5 *Power Supply*.

⁵ For details about SPI modes, see Section 2.6 *Pin Mapping Between Chip and Flash/PSRAM*.

2 Pins

2.1 Pin Layout

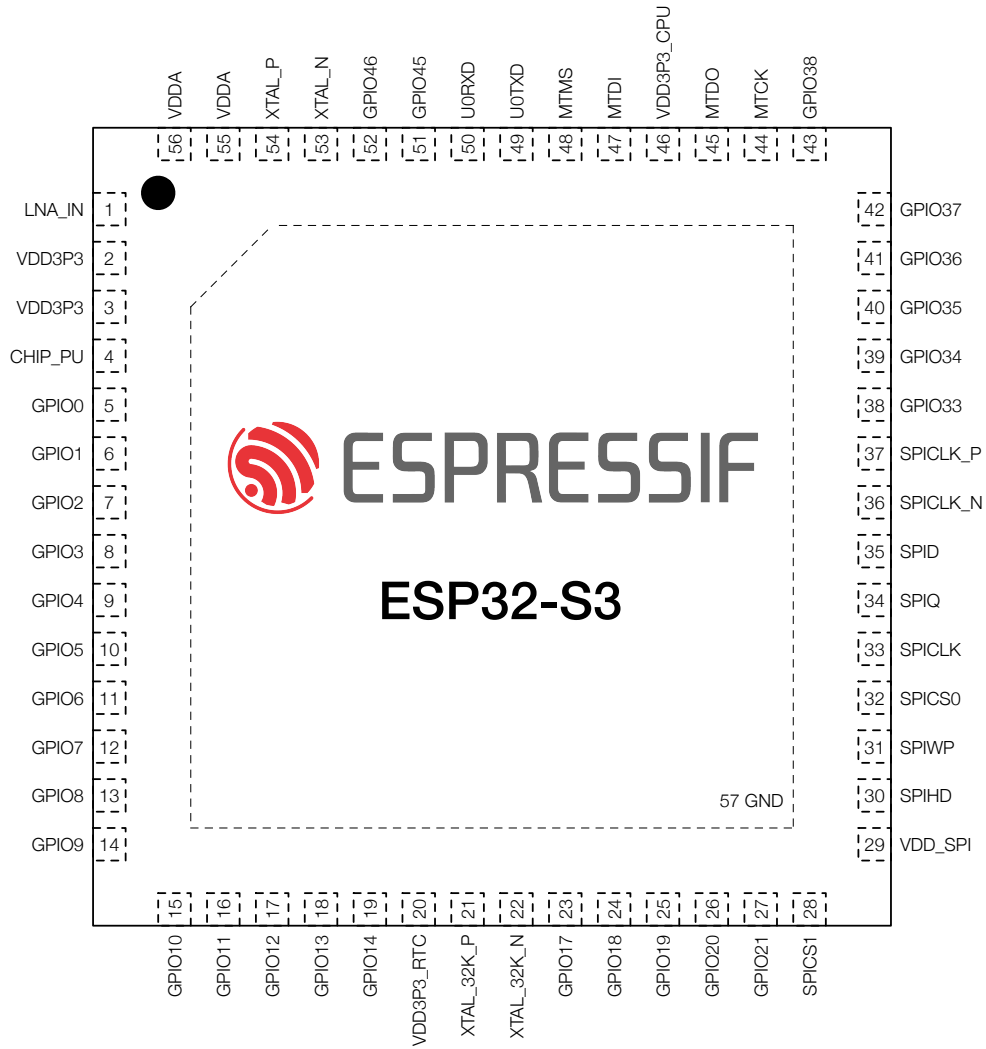

Figure 2-1. ESP32-S3 Pin Layout (Top View)

2.2 Pin Overview

The ESP32-S3 chip integrates multiple peripherals that require communication with the outside world. To keep the chip package size reasonably small, the number of available pins has to be limited. So the only way to route all the incoming and outgoing signals is through pin multiplexing. Pin muxing is controlled via software programmable registers (see [ESP32-S3 Technical Reference Manual](#) > Chapter *IO MUX and GPIO Matrix*).

All in all, the ESP32-S3 chip has the following types of pins:

- **IO pins** with the following predefined sets of functions to choose from:
 - **Each** IO pin has predefined **IO MUX functions** – see Table [2-4 IO MUX Pin Functions](#)
 - **Some** IO pins have predefined **RTC functions** – see Table [2-6 RTC Functions](#)
 - **Some** IO pins have predefined **analog functions** – see Table [2-8 Analog Functions](#)

Predefined functions means that each IO pin has a set of direct connections to certain on-chip components. During run-time, the user can configure which component from a predefined set to connect to a certain pin at a certain time via memory mapped registers (see [ESP32-S3 Technical Reference Manual](#) > Chapter *IO MUX and GPIO pins*).

- **Analog pins** that have exclusively-dedicated **analog functions** – see Table [2-9 Analog Pins](#)
- **Power pins** that supply power to the chip components and non-power pins – see Table [2-10 Power Pins](#)

Table [2-1 Pin Overview](#) gives an overview of all the pins. For more information, see the respective sections for each pin type below, or [Appendix A – ESP32-S3 Consolidated Pin Overview](#).

Table 2-1. Pin Overview

Pin No.	Pin Name	Pin Type ¹	Pin Providing Power ³⁻⁶	Pin Settings ⁷		Pin Function Sets ^{1,2}		
				At Reset	After Reset	IO MUX	RTC	Analog
1	LNA_IN	Analog						
2	VDD3P3	Power						
3	VDD3P3	Power						
4	CHIP_PU	Analog	VDD3P3_RTC					
5	GPIO0	IO	VDD3P3_RTC	IE, WPU	IE, WPU	IO MUX	RTC	
6	GPIO1	IO	VDD3P3_RTC	IE	IE	IO MUX	RTC	Analog
7	GPIO2	IO	VDD3P3_RTC	IE	IE	IO MUX	RTC	Analog
8	GPIO3	IO	VDD3P3_RTC	IE	IE	IO MUX	RTC	Analog
9	GPIO4	IO	VDD3P3_RTC			IO MUX	RTC	Analog
10	GPIO5	IO	VDD3P3_RTC			IO MUX	RTC	Analog
11	GPIO6	IO	VDD3P3_RTC			IO MUX	RTC	Analog
12	GPIO7	IO	VDD3P3_RTC			IO MUX	RTC	Analog
13	GPIO8	IO	VDD3P3_RTC			IO MUX	RTC	Analog
14	GPIO9	IO	VDD3P3_RTC		IE	IO MUX	RTC	Analog
15	GPIO10	IO	VDD3P3_RTC		IE	IO MUX	RTC	Analog
16	GPIO11	IO	VDD3P3_RTC		IE	IO MUX	RTC	Analog
17	GPIO12	IO	VDD3P3_RTC		IE	IO MUX	RTC	Analog
18	GPIO13	IO	VDD3P3_RTC		IE	IO MUX	RTC	Analog

Cont'd on next page

Table 2-1 – cont'd from previous page

Pin No.	Pin Name	Pin Type ¹	Pin Providing Power ³⁻⁶	Pin Settings ⁷		Pin Function Sets ^{1,2}		
				At Reset	After Reset	IO MUX	RTC	Analog
19	GPIO14	IO	VDD3P3_RTC		IE	IO MUX	RTC	Analog
20	VDD3P3_RTC	Power						
21	XTAL_32K_P	IO	VDD3P3_RTC			IO MUX	RTC	Analog
22	XTAL_32K_N	IO	VDD3P3_RTC			IO MUX	RTC	Analog
23	GPIO17	IO	VDD3P3_RTC		IE	IO MUX	RTC	Analog
24	GPIO18	IO	VDD3P3_RTC		IE	IO MUX	RTC	Analog
25	GPIO19	IO	VDD3P3_RTC			IO MUX	RTC	Analog
26	GPIO20	IO	VDD3P3_RTC	USB_PU	USB_PU	IO MUX	RTC	Analog
27	GPIO21	IO	VDD3P3_RTC			IO MUX	RTC	
28	SPICS1	IO	VDD_SPI	IE, WPU	IE, WPU	IO MUX		
29	VDD_SPI	Power						
30	SPIHD	IO	VDD_SPI	IE, WPU	IE, WPU	IO MUX		
31	SPIWP	IO	VDD_SPI	IE, WPU	IE, WPU	IO MUX		
32	SPICSO	IO	VDD_SPI	IE, WPU	IE, WPU	IO MUX		
33	SPICLK	IO	VDD_SPI	IE, WPU	IE, WPU	IO MUX		
34	SPIQ	IO	VDD_SPI	IE, WPU	IE, WPU	IO MUX		
35	SPID	IO	VDD_SPI	IE, WPU	IE, WPU	IO MUX		
36	SPICLK_N	IO	VDD_SPI / VDD3P3_CPU	IE	IE	IO MUX		
37	SPICLK_P	IO	VDD_SPI / VDD3P3_CPU	IE	IE	IO MUX		
38	GPIO33	IO	VDD_SPI / VDD3P3_CPU		IE	IO MUX		
39	GPIO34	IO	VDD_SPI / VDD3P3_CPU		IE	IO MUX		
40	GPIO35	IO	VDD_SPI / VDD3P3_CPU		IE	IO MUX		
41	GPIO36	IO	VDD_SPI / VDD3P3_CPU		IE	IO MUX		
42	GPIO37	IO	VDD_SPI / VDD3P3_CPU		IE	IO MUX		
43	GPIO38	IO	VDD3P3_CPU		IE	IO MUX		
44	MTCK	IO	VDD3P3_CPU		IE ⁸	IO MUX		
45	MTDO	IO	VDD3P3_CPU		IE	IO MUX		
46	VDD3P3_CPU	Power						
47	MTDI	IO	VDD3P3_CPU		IE	IO MUX		
48	MTMS	IO	VDD3P3_CPU		IE	IO MUX		
49	UOTXD	IO	VDD3P3_CPU	IE, WPU	IE, WPU	IO MUX		
50	UORXD	IO	VDD3P3_CPU	IE, WPU	IE, WPU	IO MUX		
51	GPIO45	IO	VDD3P3_CPU	IE, WPD	IE, WPD	IO MUX		
52	GPIO46	IO	VDD3P3_CPU	IE, WPD	IE, WPD	IO MUX		
53	XTAL_N	Analog						
54	XTAL_P	Analog						
55	VDDA	Power						
56	VDDA	Power						
57	GND	Power						

- For more information, see respective sections below. Alternatively, see [Appendix A – ESP32-S3 Consolidated Pin Overview](#).
- Bold** marks the pin function set in which a pin has its default function in the default boot mode. For more information about the boot mode, see Section [3.1 Chip Boot Mode Control](#).
- In column **Pin Providing Power**, regarding pins powered by VDD_SPI:
 - Power actually comes from the internal power rail supplying power to VDD_SPI. For details, see Section [2.5.2 Power Scheme](#).
- In column **Pin Providing Power**, regarding pins powered by VDD3P3_CPU / VDD_SPI:

- Pin Providing Power (either VDD3P3_CPU or VDD_SPI) is decided by eFuse bit EFUSE_PIN_POWER_SELECTION (see [ESP32-S3 Technical Reference Manual](#) > Chapter eFuse Controller) and can be configured via the IO_MUX_PAD_POWER_CTRL bit (see [ESP32-S3 Technical Reference Manual](#) > Chapter IO MUX and GPIO pins).
5. For ESP32-S3R8V chip, as the VDD_SPI voltage has been set to 1.8 V, the working voltage for pins SPICLK_N and SPICLK_P (GPIO47 and GPIO48) would also be 1.8 V, which is different from other GPIOs.
 6. The default drive strengths for each pin are as follows:
 - GPIO17 and GPIO18: 10 mA
 - GPIO19 and GPIO20: 40 mA
 - All other pins: 20 mA
 7. Column **Pin Settings** shows predefined settings at reset and after reset with the following abbreviations:
 - IE – input enabled
 - WPU – internal weak pull-up resistor enabled
 - WPD – internal weak pull-down resistor enabled
 - USB_PU – USB pull-up resistor enabled
 - By default, the USB function is enabled for USB pins (i.e., GPIO19 and GPIO20), and the pin pull-up is decided by the USB pull-up. The USB pull-up is controlled by USB_SERIAL_JTAG_DP/DM_PULLUP and the pull-up resistor value is controlled by USB_SERIAL_JTAG_PULLUP_VALUE. For details, see [ESP32-S3 Technical Reference Manual](#) > Chapter USB Serial/JTAG Controller).
 - When the USB function is disabled, USB pins are used as regular GPIOs and the pin's internal weak pull-up and pull-down resistors are disabled by default (configurable by IO_MUX_FUN_WPU/WPD). For details, see [ESP32-S3 Technical Reference Manual](#) > Chapter IO MUX and GPIO Matrix.
 8. Depends on the value of EFUSE_DIS_PAD_JTAG
 - 0 - WPU is enabled
 - 1 - pin floating

Some pins have glitches during power-up. See details in Table 2-2.

Table 2-2. Power-Up Glitches on Pins

Pin	Glitch ¹	Typical Time Period (μ s)
GPIO1	Low-level glitch	60
GPIO2	Low-level glitch	60
GPIO3	Low-level glitch	60
GPIO4	Low-level glitch	60
GPIO5	Low-level glitch	60
GPIO6	Low-level glitch	60
GPIO7	Low-level glitch	60
GPIO8	Low-level glitch	60
GPIO9	Low-level glitch	60
GPIO10	Low-level glitch	60
GPIO11	Low-level glitch	60
GPIO12	Low-level glitch	60
GPIO13	Low-level glitch	60
GPIO14	Low-level glitch	60
XTAL_32K_P	Low-level glitch	60
XTAL_32K_N	Low-level glitch	60
GPIO17	Low-level glitch	60

Cont'd on next page

Table 2-2 – cont'd from previous page

Pin	Glitch ¹	Typical Time Period (μ s)
GPIO18	Low-level glitch	60
	High-level glitch	60
GPIO19	Low-level glitch	60
	High-level glitch ²	60
GPIO20	Pull-down glitch	60
	High-level glitch ²	60

¹ Low-level glitch: the pin is at a low level output status during the time period;
 High-level glitch: the pin is at a high level output status during the time period;
 Pull-down glitch: the pin is at an internal weak pulled-down status during the time period;
 Pull-up glitch: the pin is at an internal weak pulled-up status during the time period.
 Please refer to Table [5-4 DC Characteristics \(3.3 V, 25 °C\)](#) for detailed parameters about low/high-level and pull-down/up.

² GPIO19 and GPIO20 pins both have two high-level glitches during chip power-up, each lasting for about 60 μ s. The total duration for the glitches and the delay are 3.2 ms and 2 ms respectively for GPIO19 and GPIO20.

2.3 IO Pins

2.3.1 IO MUX Functions

The IO MUX allows multiple input/output signals to be connected to a single input/output pin. Each IO pin of ESP32-S3 can be connected to one of the five signals (IO MUX functions, i.e., FO-F4), as listed in [Table 2-4 IO MUX Pin Functions](#).

Among the five sets of signals:

- Some are routed via the GPIO Matrix (**GPIO0, GPIO1, etc.**), which incorporates internal signal routing circuitry for mapping signals programmatically. It gives the pin access to almost any peripheral signals. However, the flexibility of programmatic mapping comes at a cost as it might affect the latency of routed signals. For details about connecting to peripheral signals via GPIO Matrix, see [ESP32-S3 Technical Reference Manual](#) > Chapter *IO MUX and GPIO Matrix*.
- Some are directly routed from certain peripherals (**UOTXD, MTCK, etc.**), including UART0/1, JTAG, SPI0/1, and SPI2 - see [Table 2-3 Peripheral Signals Routed via IO MUX](#).

Table 2-3. Peripheral Signals Routed via IO MUX

Pin Function	Signal	Description
U...TXD U...RXD U...RTS U...CTS	Transmit data Receive data Request to send Clear to send	UART0/1 interface
MTCK MTDO MTDI MTMS	Test clock Test Data Out Test Data In Test Mode Select	JTAG interface for debugging
SPIQ SPID SPIHD SPIWP SPICLK SPICS...	Data out Data in Hold Write protect Clock Chip select	SPI0/1 interface (powered by VDD_SPI) for connection to in-package or off-package flash/PSRAM via the SPI bus. It supports 1-, 2-, 4-line SPI modes. See also Section 2.6 Pin Mapping Between Chip and Flash/PSRAM
SPIIO... SPIDQS	Data Data strobe/data mask	SPI0/1 interface (powered by VDD_SPI or VDD3P3_CPU) for the higher 4 bits data line interface and DQS interface in 8-line SPI mode
SPICLK_N_DIFF SPICLK_P_DIFF	Negative clock signal Positive clock signal	Differential clock negative/positive for the SPI bus
SUBSPIQ SUBSPID SUBSPIHD SUBSPIWP SUBSPICLK SUBSPICS...	Data out Data in Hold Write protect Clock Chip select	SPI0/1 interface (powered by VDD3P3_RTC or VDD3V3_CPU) for connection to in-package or off-package flash/PSRAM via the SUBSPI bus. It supports 1-, 2-, 4-line SPI modes
SUBSPICLK_N_DIFF SUBSPICLK_P_DIFF	Negative clock signal Positive clock signal	Differential clock negative/positive for the SUBSPI bus

Cont'd on next page

Table 2-3 – cont'd from previous page

Pin Function	Signal	Description
FSPIQ	Data out	SPI2 interface for fast SPI connection. It supports 1-, 2-, 4-line SPI modes
FSPID	Data in	
FSPiHD	Hold	
FSPiWP	Write protect	
FSPiCLK	Clock	
FSPiCS0	Chip select	
FSPiIO...	Data	The higher 4 bits data line interface and DQS interface for SPI2 interface in 8-line SPI mode
FSPiDQS	Data strobe/data mask	
CLK_OUT...	Clock output	Output clock signals generated by the chip's internal components

Table 2-4 IO MUX Pin Functions shows the IO MUX functions of IO pins.

Table 2-4. IO MUX Pin Functions

Pin No.	IO MUX / GPIO Name ²	IO MUX Function ^{1, 2, 3}									
		F0	Type ³	F1	Type	F2	Type	F3	Type	F4	Type
5	GPIO0	GPIO0	I/O/T	GPIO0	I/O/T						
6	GPIO1	GPIO1	I/O/T	GPIO1	I/O/T						
7	GPIO2	GPIO2	I/O/T	GPIO2	I/O/T						
8	GPIO3	GPIO3	I/O/T	GPIO3	I/O/T						
9	GPIO4	GPIO4	I/O/T	GPIO4	I/O/T						
10	GPIO5	GPIO5	I/O/T	GPIO5	I/O/T						
11	GPIO6	GPIO6	I/O/T	GPIO6	I/O/T						
12	GPIO7	GPIO7	I/O/T	GPIO7	I/O/T						
13	GPIO8	GPIO8	I/O/T	GPIO8	I/O/T			SUBSPICS1	O/T		
14	GPIO9	GPIO9	I/O/T	GPIO9	I/O/T			SUBSPiHD	I/O/T	FSPiHD	I/O/T
15	GPIO10	GPIO10	I/O/T	GPIO10	I/O/T	FSPiIO4	I/O/T	SUBSPICS0	O/T	FSPICS0	I/O/T
16	GPIO11	GPIO11	I/O/T	GPIO11	I/O/T	FSPiIO5	I/O/T	SUBSPID	I/O/T	FSPID	I/O/T
17	GPIO12	GPIO12	I/O/T	GPIO12	I/O/T	FSPiIO6	I/O/T	SUBSPiCLK	O/T	FSPiCLK	I/O/T
18	GPIO13	GPIO13	I/O/T	GPIO13	I/O/T	FSPiIO7	I/O/T	SUBSPiQ	I/O/T	FSPiQ	I/O/T
19	GPIO14	GPIO14	I/O/T	GPIO14	I/O/T	FSPiDQS	O/T	SUBSPiWP	I/O/T	FSPiWP	I/O/T
21	GPIO15	GPIO15	I/O/T	GPIO15	I/O/T	UORTS	0				
22	GPIO16	GPIO16	I/O/T	GPIO16	I/O/T	UOCTS	I				
23	GPIO17	GPIO17	I/O/T	GPIO17	I/O/T	U1TXD	0				
24	GPIO18	GPIO18	I/O/T	GPIO18	I/O/T	U1RXD	I	CLK_OUT3	0		
25	GPIO19	GPIO19	I/O/T	GPIO19	I/O/T	U1RTS	0	CLK_OUT2	0		
26	GPIO20	GPIO20	I/O/T	GPIO20	I/O/T	U1CTS	I	CLK_OUT1	0		
27	GPIO21	GPIO21	I/O/T	GPIO21	I/O/T						

Cont'd on next page

Table 2-4 – cont'd from previous page

Pin No.	IO MUX / GPIO Name ²	IO MUX Function ^{1, 2, 3}												
		FO ^{4a}	Type ³	F1	Type	F2	Type	F3	Type	F4	Type			
28	GPIO26	SPICS1	O/T	GPIO26	I/O/T									
30	GPIO27	SPIHD	I/O/T	GPIO27	I/O/T									
31	GPIO28	SPIWP	I/O/T	GPIO28	I/O/T									
32	GPIO29	SPICS0	O/T	GPIO29	I/O/T									
33	GPIO30	SPICLK	O/T	GPIO30	I/O/T									
34	GPIO31	SPIQ	I/O/T	GPIO31	I/O/T									
35	GPIO32	SPID	I/O/T	GPIO32	I/O/T									
38	GPIO33	GPIO33	I/O/T	GPIO33	I/O/T	FSPIHD	I/O/T	SUBSPIHD	I/O/T	SPIIO4	I/O/T			
39	GPIO34	GPIO34	I/O/T	GPIO34	I/O/T	FSPICSO	I/O/T	SUBSPICSO	O/T	SPIIO5	I/O/T			
40	GPIO35	GPIO35	I/O/T	GPIO35	I/O/T	FSPID	I/O/T	SUBSPID	I/O/T	SPIIO6	I/O/T			
41	GPIO36	GPIO36	I/O/T	GPIO36	I/O/T	FSPICLK	I/O/T	SUBSPICLK	O/T	SPIIO7	I/O/T			
42	GPIO37	GPIO37	I/O/T	GPIO37	I/O/T	FSPIQ	I/O/T	SUBSPIQ	I/O/T	SPIDQS	I/O/T			
43	GPIO38	GPIO38	I/O/T	GPIO38	I/O/T	FSPIWP	I/O/T	SUBSPIWP	I/O/T					
44	GPIO39	MTCK	I	GPIO39	I/O/T	CLK_OUT3	O	SUBSPICS1	O/T					
45	GPIO40	MTDO	O/T	GPIO40	I/O/T	CLK_OUT2	O							
47	GPIO41	MTDI	I	GPIO41	I/O/T	CLK_OUT1	O							
48	GPIO42	MTMS	I	GPIO42	I/O/T									
49	GPIO43	UOTXD	O	GPIO43	I/O/T	CLK_OUT1	O							
50	GPIO44	UORXD	I	GPIO44	I/O/T	CLK_OUT2	O							
51	GPIO45	GPIO45	I/O/T	GPIO45	I/O/T									
52	GPIO46	GPIO46	I/O/T	GPIO46	I/O/T									
37	GPIO47	SPI CLK_P_DIFF	O/T	GPIO47	I/O/T	SUBSPI CLK_P_DIFF	O/T							
36	GPIO48	SPI CLK_N_DIFF	O/T	GPIO48	I/O/T	SUBSPI CLK_N_DIFF	O/T							

¹ **Bold** marks the default pin functions in the default boot mode. For more information about the boot mode, see Section 3.1 [Chip Boot Mode Control](#).

² Regarding **highlighted** cells, see Section 2.3.4 [Restrictions for GPIOs and RTC_GPIOs](#).

³ Each IO MUX function (F_n , $n = 0 \sim 4$) is associated with a *type*. The description of *type* is as follows:

- I – input. O – output. T – high impedance.
- I1 – input; if the pin is assigned a function other than F_n , the input signal of F_n is always 1.
- IO – input; if the pin is assigned a function other than F_n , the input signal of F_n is always 0.

^{4a-4g} For detailed pin assignment of SPI, please refer to 4.2.1.5 [Serial Peripheral Interface \(SPI\) > Pin Assignment](#).

2.3.2 RTC Functions

When the chip is in Deep-sleep mode, the IO MUX described in Section 2.3.1 [IO MUX Functions](#) will not work. That is where the RTC IO MUX comes in. It allows multiple input/output signals to be a single input/output pin in Deep-sleep mode, as the pin is connected to the RTC system and powered by VDD3P3_RTC.

RTC IO pins can be assigned to **RTC functions**. They can

- Either work as RTC GPIOs (**RTC_GPIO0, RTC_GPIO1, etc.**), connected to the ULP coprocessor
- Or connect to RTC peripheral signals (**sar_i2c_scl_0, sar_i2c_sda_0, etc.**) - see Table 2-5 [RTC Peripheral Signals Routed via RTC IO MUX](#)

Table 2-5. RTC Peripheral Signals Routed via RTC IO MUX

Pin Function	Signal	Description
sar_i2c_scl...	Serial clock	RTC I2CO/1 interface
sar_i2c_sda...	Serial data	

Table 2-6 *RTC Functions* shows the RTC functions of RTC IO pins.

Table 2-6. RTC Functions

Pin No.	RTC IO Name ¹	RTC Function ²			
		FO	F1	F2	F3
5	RTC_GPIO0	RTC_GPIO0			sar_i2c_scl_0
6	RTC_GPIO1	RTC_GPIO1			sar_i2c_sda_0
7	RTC_GPIO2	RTC_GPIO2			sar_i2c_scl_1
8	RTC_GPIO3	RTC_GPIO3			sar_i2c_sda_1
9	RTC_GPIO4	RTC_GPIO4			
10	RTC_GPIO5	RTC_GPIO5			
11	RTC_GPIO6	RTC_GPIO6			
12	RTC_GPIO7	RTC_GPIO7			
13	RTC_GPIO8	RTC_GPIO8			
14	RTC_GPIO9	RTC_GPIO9			
15	RTC_GPIO10	RTC_GPIO10			
16	RTC_GPIO11	RTC_GPIO11			
17	RTC_GPIO12	RTC_GPIO12			
18	RTC_GPIO13	RTC_GPIO13			
19	RTC_GPIO14	RTC_GPIO14			
21	RTC_GPIO15	RTC_GPIO15			
22	RTC_GPIO16	RTC_GPIO16			
23	RTC_GPIO17	RTC_GPIO17			
24	RTC_GPIO18	RTC_GPIO18			
25	RTC_GPIO19	RTC_GPIO19			
26	RTC_GPIO20	RTC_GPIO20			
27	RTC_GPIO21	RTC_GPIO21			

¹ This column lists the RTC GPIO names, since RTC functions are configured with RTC GPIO registers that use RTC GPIO numbering.

² Regarding highlighted cells, see Section 2.3.4 *Restrictions for GPIOs and RTC_GPIOs*.

2.3.3 Analog Functions

Some IO pins also have **analog functions**, for analog peripherals (such as ADC) in any power mode. Internal analog signals are routed to these analog functions, see Table 2-7 *Analog Signals Routed to Analog Functions*.

Table 2-7. Analog Signals Routed to Analog Functions

Pin Function	Signal	Description
TOUCH...	Touch sensor channel ... signal	Touch sensor interface
ADC..._CH...	ADC1/2 channel ... signal	ADC1/2 interface
XTAL_32K_N	Negative clock signal	32 kHz external clock input/output connected to ESP32-S3's oscillator
XTAL_32K_P	Positive clock signal	
USB_D-	Data -	USB OTG and USB Serial/JTAG function
USB_D+	Data +	

Table 2-8 *Analog Functions* shows the analog functions of IO pins.

Table 2-8. Analog Functions

Pin No.	Analog IO Name ^{1, 2}	Analog Function ³	
		F0	F1
5	RTC_GPIO0		
6	RTC_GPIO1	TOUCH1	ADC1_CH0
7	RTC_GPIO2	TOUCH2	ADC1_CH1
8	RTC_GPIO3	TOUCH3	ADC1_CH2
9	RTC_GPIO4	TOUCH4	ADC1_CH3
10	RTC_GPIO5	TOUCH5	ADC1_CH4
11	RTC_GPIO6	TOUCH6	ADC1_CH5
12	RTC_GPIO7	TOUCH7	ADC1_CH6
13	RTC_GPIO8	TOUCH8	ADC1_CH7
14	RTC_GPIO9	TOUCH9	ADC1_CH8
15	RTC_GPIO10	TOUCH10	ADC1_CH9
16	RTC_GPIO11	TOUCH11	ADC2_CH0
17	RTC_GPIO12	TOUCH12	ADC2_CH1
18	RTC_GPIO13	TOUCH13	ADC2_CH2
19	RTC_GPIO14	TOUCH14	ADC2_CH3
21	RTC_GPIO15	XTAL_32K_P	ADC2_CH4
22	RTC_GPIO16	XTAL_32K_N	ADC2_CH5
23	RTC_GPIO17		ADC2_CH6
24	RTC_GPIO18		ADC2_CH7
25	RTC_GPIO19	USB_D-	ADC2_CH8
26	RTC_GPIO20	USB_D+	ADC2_CH9
27	RTC_GPIO21		

¹ **Bold** marks the default pin functions in the default boot mode. For more information about the boot mode, see Section 3.1 *Chip Boot Mode Control*.

² This column lists the RTC GPIO names, since analog functions are configured with RTC GPIO registers that use RTC GPIO numbering.

³ Regarding **highlighted** cells, see Section 2.3.4 *Restrictions for GPIOs and RTC_GPIOs*.

2.3.4 Restrictions for GPIOs and RTC_GPIOs

All IO pins of ESP32-S3 have GPIO and some have RTC_GPIO pin functions. However, the IO pins are multiplexed and can be configured for different purposes based on the requirements. Some IOs have restrictions for usage. It is essential to consider the multiplexed nature and the limitations when using these IO pins.

In tables of this chapter, some pin functions are **highlighted**. The non-highlighted GPIO or RTC_GPIO pins are recommended for use first. If more pins are needed, the highlighted GPIOs or RTC_GPIOs should be chosen carefully to avoid conflicts with important pin functions.

The highlighted IO pins have the following important pin functions:

- **GPIO** – allocated for communication with in-package flash/PSRAM and NOT recommended for other uses. For details, see Section [2.6 Pin Mapping Between Chip and Flash/PSRAM](#).
- **GPIO** – no restrictions, unless the chip is connected to flash/PSRAM using 8-line SPI mode. For details, see Section [2.6 Pin Mapping Between Chip and Flash/PSRAM](#).
- **GPIO** – have one of the following important functions:
 - **Strapping pins** – need to be at certain logic levels at startup. See Section [3 Boot Configurations](#).
 - **USB_D+/-** – by default, connected to the USB Serial/JTAG Controller. To function as GPIOs, these pins need to be reconfigured via the IO_MUX_MCU_SEL bit (see [ESP32-S3 Technical Reference Manual](#) > Chapter *IO MUX and GPIO Matrix* for details).
 - **JTAG interface** – often used for debugging. See Table [2-4 IO MUX Pin Functions](#). To free these pins up, the pin functions USB_D+/- of the USB Serial/JTAG Controller can be used instead. See also Section [3.4 JTAG Signal Source Control](#).
 - **UART interface** – often used for debugging. See Table [2-4 IO MUX Pin Functions](#).

See also [Appendix A – ESP32-S3 Consolidated Pin Overview](#).

2.4 Analog Pins

Table 2-9. Analog Pins

Pin No.	Pin Name	Pin Type	Pin Function
1	LNA_IN	I/O	Low Noise Amplifier (RF LNA) input/output signals
4	CHIP_PU	I	High: on, enables the chip (powered up). Low: off, disables the chip (powered down). Note: Do not leave the CHIP_PU pin floating.
53	XTAL_N	—	External clock input/output connected to chip's crystal or oscillator. P/N means differential clock positive/negative.
54	XTAL_P	—	

2.5 Power Supply

2.5.1 Power Pins

The chip is powered via the power pins described in Table 2-10 *Power Pins*.

Table 2-10. Power Pins

Pin No.	Pin Name	Direction	Power Supply ^{1,2}	
			Power Domain / Other	IO Pins ⁵
2	VDD3P3	Input	Analog power domain	
3	VDD3P3	Input	Analog power domain	
20	VDD3P3_RTC	Input	RTC and part of Digital power domains	RTC IO
29	VDD_SPI ^{3,4}	Input	In-package memory (backup power line)	
		Output	In-package and off-package flash/PSRAM	SPI IO
46	VDD3P3_CPU	Input	Digital power domain	Digital IO
55	VDDA	Input	Analog power domain	
56	VDDA	Input	Analog power domain	
57	GND	–	External ground connection	

¹ See in conjunction with Section 2.5.2 *Power Scheme*.

² For recommended and maximum voltage and current, see Section 5.1 *Absolute Maximum Ratings* and Section 5.2 *Recommended Power Supply Characteristics*.

³ To configure VDD_SPI as input or output, see [ESP32-S3 Technical Reference Manual](#) > Chapter *Low-power Management*.

⁴ To configure output voltage, see Section 3.2 *VDD_SPI Voltage Control* and Section 5.3 *VDD_SPI Output Characteristics*.

⁵ RTC IO pins are those powered by VDD3P3_RTC and so on, as shown in Figure 2-2 *ESP32-S3 Power Scheme*. See also Table 2-1 *Pin Overview* > Column *Pin Providing Power*.

2.5.2 Power Scheme

The power scheme is shown in Figure 2-2 *ESP32-S3 Power Scheme*.

The components on the chip are powered via voltage regulators.

Table 2-11. Voltage Regulators

Voltage Regulator	Output	Power Supply
Digital	1.1 V	Digital power domain
Low-power	1.1 V	RTC power domain
Flash	1.8 V	Can be configured to power in-package flash/PSRAM or off-package memory

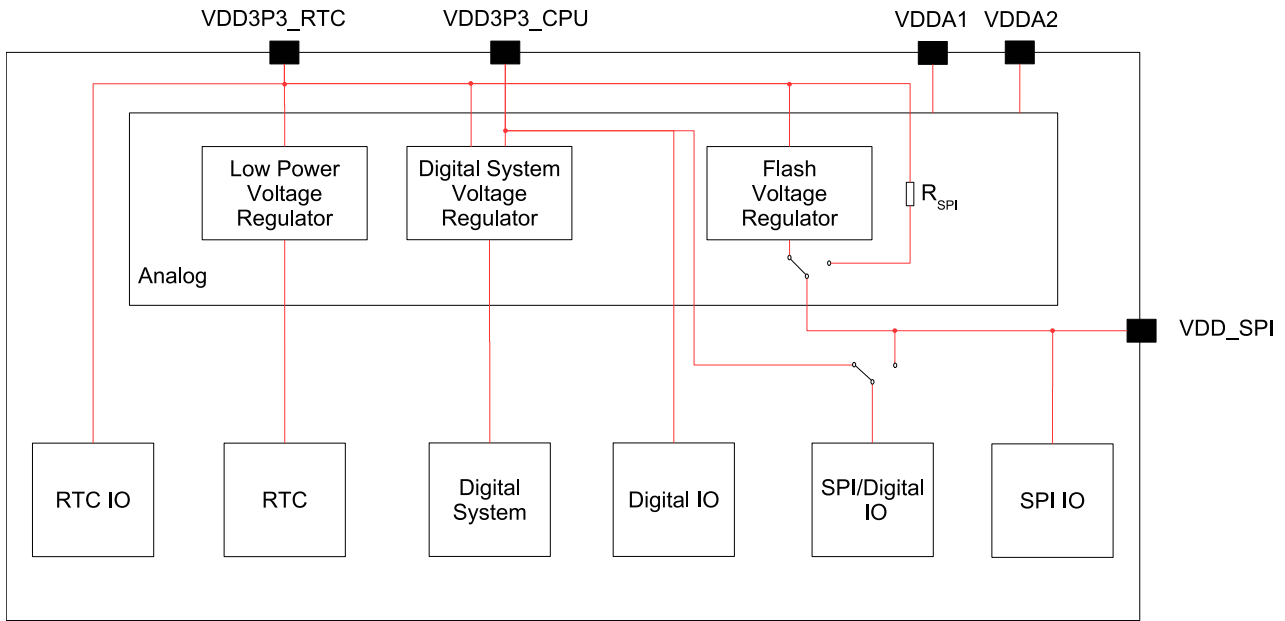

Figure 2-2. ESP32-S3 Power Scheme

2.5.3 Chip Power-up and Reset

Once the power is supplied to the chip, its power rails need a short time to stabilize. After that, CHIP_PU – the pin used for power-up and reset – is pulled high to activate the chip. For information on CHIP_PU as well as power-up and reset timing, see Figure 2-3 and Table 2-12.

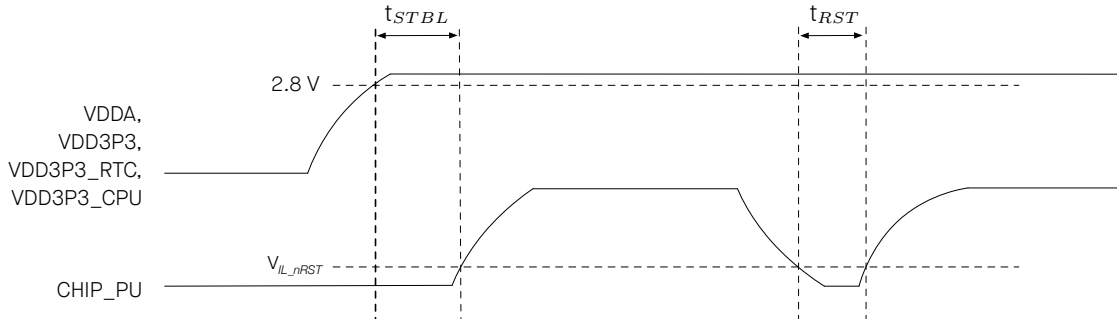

Figure 2-3. Visualization of Timing Parameters for Power-up and Reset

Table 2-12. Description of Timing Parameters for Power-up and Reset

Parameter	Description	Min (μs)
t _{STBL}	Time reserved for the power rails of VDDA, VDD3P3, VDD3P3_RTC, and VDD3P3_CPU to stabilize before the CHIP_PU pin is pulled high to activate the chip	50
t _{RST}	Time reserved for CHIP_PU to stay below V _{IL_nRST} to reset the chip (see Table 5-4)	50

2.6 Pin Mapping Between Chip and Flash/PSRAM

Table 2-13 lists the pin mapping between the chip and flash/PSRAM for all SPI modes.

For chip variants with in-package flash/PSRAM (see Table 1-1 *ESP32-S3 Series Comparison*), the pins allocated for communication with in-package flash/PSRAM can be identified depending on the SPI mode used.

For off-package flash/PSRAM, these are the recommended pin mappings.

For more information on SPI controllers, see also Section 4.2.1.5 *Serial Peripheral Interface (SPI)*.

Notice:

It is not recommended to use the pins connected to flash/PSRAM for any other purposes.

Table 2-13. Pin Mapping Between Chip and In-package Flash/ PSRAM

Pin No.	Pin Name	Single SPI		Dual SPI		Quad SPI / QPI		Octal SPI / OPI	
		Flash	PSRAM	Flash	PSRAM	Flash	PSRAM	Flash	PSRAM
33	SPICLK	CLK	CLK	CLK	CLK	CLK	CLK	CLK	CLK
32	SPICSO ¹	CS#		CS#		CS#		CS#	
28	SPICS1 ²		CE#		CE#		CE#		CE#
35	SPID	DI	SI/SIO0	DI	SI/SIO0	DI	SI/SIO0	DQ0	DQ0
34	SPIQ	DO	SO/SIO1	DO	SO/SIO1	DO	SO/SIO1	DQ1	DQ1
31	SPIWP	WP#	SIO2	WP#	SIO2	WP#	SIO2	DQ2	DQ2
30	SPIHD	HOLD#	SIO3	HOLD#	SIO3	HOLD#	SIO3	DQ3	DQ3
38	GPIO33							DQ4	DQ4
39	GPIO34							DQ5	DQ5
40	GPIO35							DQ6	DQ6
41	GPIO36							DQ7	DQ7
42	GPIO37							DQS/DM	DQS/DM

¹ CS0 is for in-package flash

² CS1 is for in-package PSRAM

3 Boot Configurations

The chip allows for configuring the following boot parameters through strapping pins and eFuse bits at power-up or a hardware reset, without microcontroller interaction.

- **Chip boot mode**
 - Strapping pin: GPIO0 and GPIO46
- **VDD_SPI voltage**
 - Strapping pin: GPIO45
 - eFuse parameter: EFUSE_VDD_SPI_FORCE and EFUSE_VDD_SPI_TIEH
- **ROM message printing**
 - Strapping pin: GPIO46
 - eFuse parameter: EFUSE_UART_PRINT_CONTROL and EFUSE_DIS_USB_SERIAL_JTAG_ROM_PRINT
- **JTAG signal source**
 - Strapping pin: GPIO3
 - eFuse parameter: EFUSE_DIS_PAD_JTAG, EFUSE_DIS_USB_JTAG, and EFUSE_STRAP_JTAG_SEL

The default values of all the above eFuse parameters are 0, which means that they are not burnt. Given that eFuse is one-time programmable, once programmed to 1, it can never be reverted to 0. For how to program eFuse parameters, please refer to [ESP32-S3 Technical Reference Manual](#) > Chapter *eFuse Controller*.

The default values of the strapping pins, namely the logic levels, are determined by pins' internal weak pull-up/pull-down resistors at reset if the pins are not connected to any circuit, or connected to an external high-impedance circuit.

Table 3-1. Default Configuration of Strapping Pins

Strapping Pin	Default Configuration	Bit Value
GPIO0	Weak pull-up	1
GPIO3	Floating	–
GPIO45	Weak pull-down	0
GPIO46	Weak pull-down	0

To change the bit values, the strapping pins should be connected to external pull-down/pull-up resistances. If the ESP32-S3 is used as a device by a host MCU, the strapping pin voltage levels can also be controlled by the host MCU.

All strapping pins have latches. At system reset, the latches sample the bit values of their respective strapping pins and store them until the chip is powered down or shut down. The states of latches cannot be changed in any other way. It makes the strapping pin values available during the entire chip operation, and the pins are freed up to be used as regular IO pins after reset.

The timing of signals connected to the strapping pins should adhere to the *setup time* and *hold time* specifications in Table 3-2 and Figure 3-1.

Table 3-2. Description of Timing Parameters for the Strapping Pins

Parameter	Description	Min (ms)
t_{SU}	Setup time is the time reserved for the power rails to stabilize before the CHIP_PU pin is pulled high to activate the chip.	0
t_H	Hold time is the time reserved for the chip to read the strapping pin values after CHIP_PU is already high and before these pins start operating as regular IO pins.	3

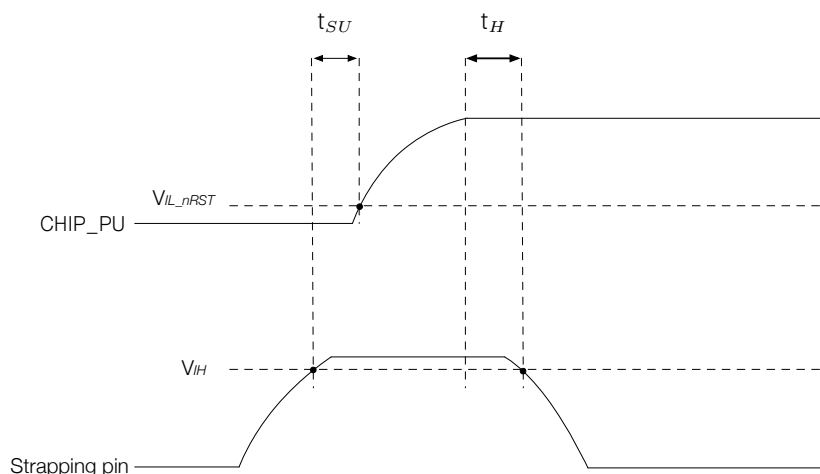

Figure 3-1. Visualization of Timing Parameters for the Strapping Pins

3.1 Chip Boot Mode Control

GPIO0 and GPIO46 control the boot mode after the reset is released. See Table 3-3 *Chip Boot Mode Control*.

Table 3-3. Chip Boot Mode Control

Boot Mode	GPIO0	GPIO46
SPI Boot	1	Any value
Joint Download Boot ²	0	0

¹ **Bold** marks the default value and configuration.

² Joint Download Boot mode supports the following download methods:

- USB Download Boot:
 - USB-Serial-JTAG Download Boot
 - USB-OTG Download Boot
- UART Download Boot

In SPI Boot mode, the ROM bootloader loads and executes the program from SPI flash to boot the system.

In Joint Download Boot mode, users can download binary files into flash using UART0 or USB interface. It is also possible to download binary files into SRAM and execute it from SRAM.

In addition to SPI Boot and Joint Download Boot modes, ESP32-S3 also supports SPI Download Boot mode. For details, please see [ESP32-S3 Technical Reference Manual](#) > Chapter *Chip Boot Control*.

3.2 VDD_SPI Voltage Control

The required VDD_SPI voltage for the chips of the ESP32-S3 series can be found in Table 1-1 [ESP32-S3 Series Comparison](#).

Depending on the value of EFUSE_VDD_SPI_FORCE, the voltage can be controlled in two ways.

Table 3-4. VDD_SPI Voltage Control

VDD_SPI power source ²	Voltage	EFUSE_VDD_SPI_FORCE	GPIO45	EFUSE_VDD_SPI_TIEH
VDD3P3_RTC via R _{SPI}	3.3 V	0	0	Ignored
Flash Voltage Regulator	1.8 V		1	
Flash Voltage Regulator	1.8 V	1	Ignored	0
VDD3P3_RTC via R _{SPI}	3.3 V			1

¹ **Bold** marks the default value and configuration.

² See Section 2.5.2 [Power Scheme](#).

3.3 ROM Messages Printing Control

During boot process the messages by the ROM code can be printed to:

- **(Default) UART0 and USB Serial/JTAG controller**
- USB Serial/JTAG controller
- UART0

The ROM messages printing to UART or USB Serial/JTAG controller can be respectively disabled by configuring registers and eFuse. For detailed information, please refer to [ESP32-S3 Technical Reference Manual](#) > Chapter *Chip Boot Control*.

3.4 JTAG Signal Source Control

The strapping pin GPIO3 can be used to control the source of JTAG signals during the early boot process. This pin does not have any internal pull resistors and the strapping value must be controlled by the external circuit that cannot be in a high impedance state.

As Table 3-5 shows, GPIO3 is used in combination with EFUSE_DIS_PAD_JTAG, EFUSE_DIS_USB_JTAG, and EFUSE_STRAP_JTAG_SEL.

Table 3-5. JTAG Signal Source Control

JTAG Signal Source	EFUSE_DIS_PAD_JTAG	EFUSE_DIS_USB_JTAG	EFUSE_STRAP_JTAG_SEL	GPIO3
USB Serial/JTAG Controller	0	0	0	Ignored
	0	0	1	1
	1	0	Ignored	Ignored
JTAG pins ²	0	0	1	0
	0	1	Ignored	Ignored
JTAG is disabled	1	1	Ignored	Ignored

¹ **Bold** marks the default value and configuration.

² JTAG pins refer to MTDI, MTCK, MTMS, and MTDO.

4 Functional Description

4.1 System

This section describes the core of the chip's operation, covering its microprocessor, memory organization, system components, and security features.

4.1.1 Microprocessor and Master

This subsection describes the core processing units within the chip and their capabilities.

4.1.1.1 CPU

ESP32-S3 has a low-power Xtensa® dual-core 32-bit LX7 microprocessor.

Feature List

- Five-stage pipeline that supports the clock frequency of up to 240 MHz
- 16-bit/24-bit instruction set providing high code density
- 32-bit customized instruction set and 128-bit data bus that provide high computing performance
- Support for single-precision floating-point unit (FPU)
- 32-bit multiplier and 32-bit divider
- Unbuffered GPIO instructions
- 32 interrupts at six levels
- Windowed ABI with 64 physical general registers
- Trace function with TRAX compressor, up to 16 KB trace memory
- JTAG for debugging

For information about the Xtensa® Instruction Set Architecture, please refer to [Xtensa® Instruction Set Architecture \(ISA\) Summary](#).

4.1.1.2 Processor Instruction Extensions (PIE)

ESP32-S3 contains a series of new extended instruction set in order to improve the operation efficiency of specific AI and DSP (Digital Signal Processing) algorithms.

Feature List

- 128-bit new general-purpose registers
- 128-bit vector operations, e.g., complex multiplication, addition, subtraction, multiplication, shifting, comparison, etc
- Data handling instructions and load/store operation instructions combined
- Non-aligned 128-bit vector data

- Saturation operation

For details, see [ESP32-S3 Technical Reference Manual](#) > Chapter *Processor Instruction Extensions*.

4.1.1.3 Ultra-Low-Power Coprocessor (ULP)

The ULP coprocessor is designed as a simplified, low-power replacement of CPU in sleep modes. It can be also used to supplement the functions of the CPU in normal working mode. The ULP coprocessor and RTC memory remain powered up during the Deep-sleep mode. Hence, the developer can store a program for the ULP coprocessor in the RTC slow memory to access RTC GPIO, RTC peripheral devices, RTC timers and internal sensors in Deep-sleep mode.

ESP32-S3 has two ULP coprocessors, one based on RISC-V instruction set architecture (ULP-RISC-V) and the other on finite state machine (ULP-FSM). The clock of the coprocessors is the internal fast RC oscillator.

Feature List

- ULP-RISC-V:
 - Support for [RV32IMC](#) instruction set
 - Thirty-two 32-bit general-purpose registers
 - 32-bit multiplier and divider
 - Support for interrupts
 - Booted by the CPU, its dedicated timer, or RTC GPIO
- ULP-FSM:
 - Support for common instructions including arithmetic, jump, and program control instructions
 - Support for on-board sensor measurement instructions
 - Booted by the CPU, its dedicated timer, or RTC GPIO

Note:

Note that these two coprocessors cannot work simultaneously.

For details, see [ESP32-S3 Technical Reference Manual](#) > Chapter *ULP Coprocessor*.

4.1.1.4 GDMA Controller (GDMA)

ESP32-S3 has a general-purpose DMA controller (GDMA) with five independent channels for transmitting and another five independent channels for receiving. These ten channels are shared by peripherals that have DMA feature, and support dynamic priority.

The GDMA controller controls data transfer using linked lists. It allows peripheral-to-memory and memory-to-memory data transfer at a high speed. All channels can access internal and external RAM.

The ten peripherals on ESP32-S3 with DMA feature are SPI2, SPI3, UHCIO, I2S0, I2S1, LCD/CAM, AES, SHA, ADC, and RMT.

For details, see [ESP32-S3 Technical Reference Manual](#) > Chapter *GDMA Controller*.

4.1.2 Memory Organization

This subsection describes the memory arrangement to explain how data is stored, accessed, and managed for efficient operation.

Figure 4-1 illustrates the address mapping structure of ESP32-S3.

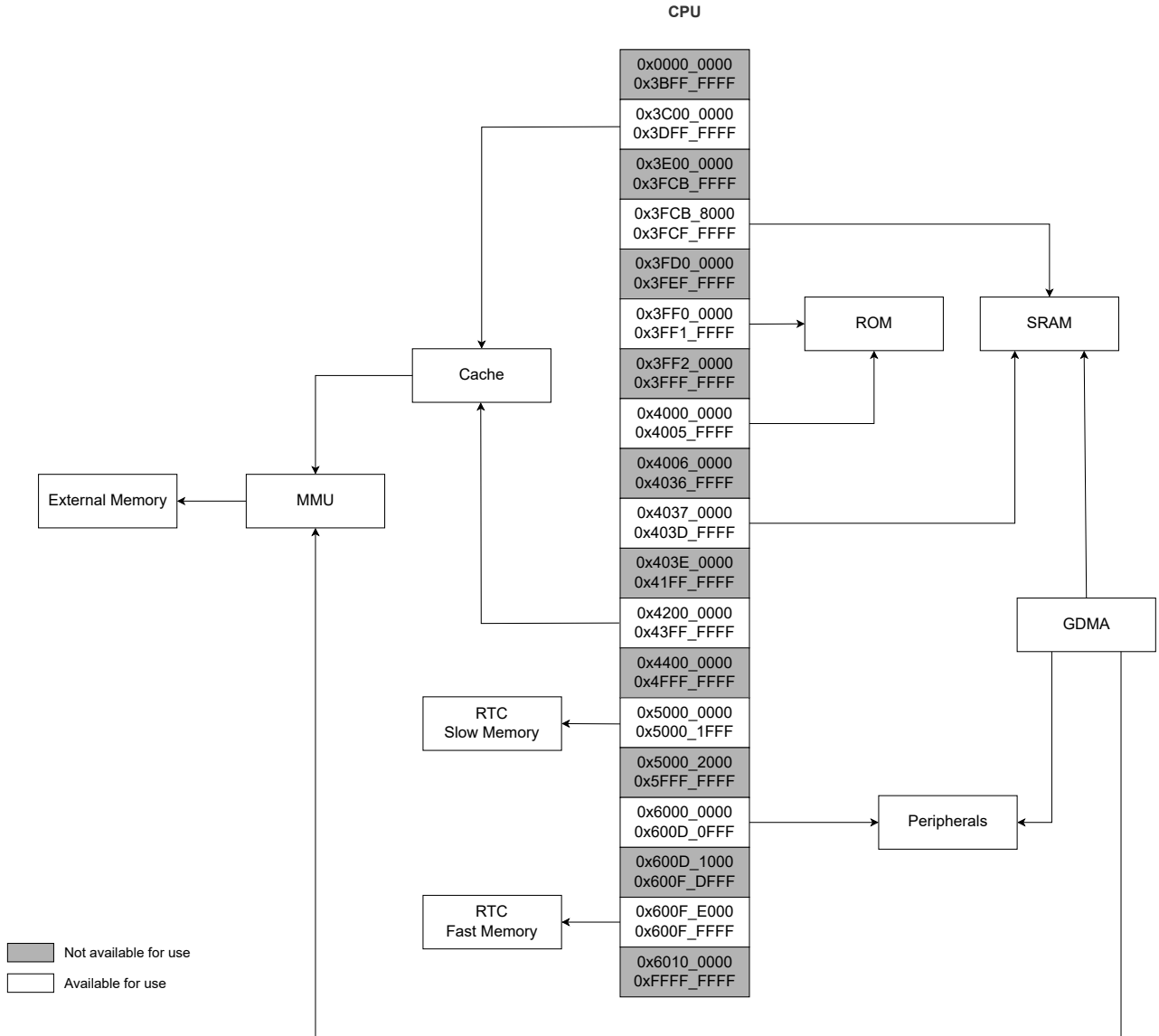

Figure 4-1. Address Mapping Structure

Note:
 The memory space with gray background is not available to users.

4.1.2.1 Internal Memory

The internal memory of ESP32-S3 refers to the memory integrated on the chip die or in the chip package, including ROM, SRAM, eFuse, and flash.

Feature List

- **384 KB ROM:** for booting and core functions
- **512 KB on-chip SRAM:** for data and instructions, running at a configurable frequency of up to 240 MHz
- **RTC FAST memory:** 8 KB SRAM that supports read/write/instruction fetch by the main CPU (LX7 dual-core processor). It can retain data in Deep-sleep mode
- **RTC SLOW Memory:** 8 KB SRAM that supports read/write/instruction fetch by the main CPU (LX7 dual-core processor) or coprocessors. It can retain data in Deep-sleep mode
- **4 Kbit eFuse:** 1792 bits are available for users, such as encryption key and device ID. See also Section [4.1.2.4 eFuse Controller](#)
- **In-package flash:**
 - See flash size in Chapter [1 ESP32-S3 Series Comparison](#)
 - More than 100,000 program/erase cycles
 - More than 20 years of data retention time
 - Clock frequency up to 80 MHz by default
- **In-package PSRAM:** See details in Table [1-1 ESP32-S3 Series Comparison](#)

For details, see [ESP32-S3 Technical Reference Manual](#) > Chapter *System and Memory*.

4.1.2.2 External Flash and RAM

ESP32-S3 supports SPI, Dual SPI, Quad SPI, Octal SPI, QPI, and OPI interfaces that allow connection to multiple external flash and RAM.

The external flash and RAM can be mapped into the CPU instruction memory space and read-only data memory space. The external RAM can also be mapped into the CPU data memory space. ESP32-S3 supports up to 1 GB of external flash and RAM, and hardware encryption/decryption based on XTS-AES to protect users' programs and data in flash and external RAM.

Through high-speed caches, ESP32-S3 can support at a time up to:

- External flash or RAM mapped into 32 MB instruction space as individual blocks of 64 KB
- External RAM mapped into 32 MB data space as individual blocks of 64 KB. 8-bit, 16-bit, 32-bit, and 128-bit reads and writes are supported. External flash can also be mapped into 32 MB data space as individual blocks of 64 KB, but only supporting 8-bit, 16-bit, 32-bit and 128-bit reads.

Note:

After ESP32-S3 is initialized, firmware can customize the mapping of external RAM or flash into the CPU address space.

For details, see [ESP32-S3 Technical Reference Manual](#) > Chapter *System and Memory*.

4.1.2.3 Cache

ESP32-S3 has an instruction cache and a data cache shared by the two CPU cores. Each cache can be partitioned into multiple banks.

Feature List

- Instruction cache: 16 KB (one bank) or 32 KB (two banks)
Data cache: 32 KB (one bank) or 64 KB (two banks)
- Instruction cache: four-way or eight-way set associative
Data cache: four-way set associative
- Block size of 16 bytes or 32 bytes for both instruction cache and data cache
- Pre-load function
- Lock function
- Critical word first and early restart

For details, see [ESP32-S3 Technical Reference Manual](#) > Chapter *System and Memory*.

4.1.2.4 eFuse Controller

ESP32-S3 contains a 4-Kbit eFuse to store parameters, which are burned and read by an eFuse controller.

Feature List

- 4 Kbits in total, with 1792 bits reserved for users, e.g., encryption key and device ID
- One-time programmable storage
- Configurable write protection
- Configurable read protection
- Various hardware encoding schemes to protect against data corruption

For details, see [ESP32-S3 Technical Reference Manual](#) > Chapter *eFuse Controller*.

4.1.3 System Components

This subsection describes the essential components that contribute to the overall functionality and control of the system.

4.1.3.1 IO MUX and GPIO Matrix

The IO MUX and GPIO Matrix in the ESP32-S3 chip provide flexible routing of peripheral input and output signals to the GPIO pins. These peripherals enhance the functionality and performance of the chip by allowing the configuration of I/O, support for multiplexing, and signal synchronization for peripheral inputs.

Feature List

- GPIO Matrix:
 - A full-switching matrix between the peripheral input/output signals and the GPIO pins
 - 175 digital peripheral input signals can be sourced from the input of any GPIO pins
 - The output of any GPIO pins can be from any of the 184 digital peripheral output signals
 - Supports signal synchronization for peripheral inputs based on APB clock bus
 - Provides input signal filter
 - Supports sigma delta modulated output
 - Supports GPIO simple input and output
- IO MUX:
 - Provides one configuration register `IO_MUX_GPIO n _REG` for each GPIO pin. The pin can be configured to
 - * perform GPIO function routed by GPIO matrix
 - * or perform direct connection bypassing GPIO matrix
 - Supports some high-speed digital signals (SPI, JTAG, UART) bypassing GPIO matrix for better high-frequency digital performance (IO MUX is used to connect these pins directly to peripherals)
- RTC IO MUX:
 - Controls low power feature of 22 RTC GPIO pins
 - Controls analog functions of 22 RTC GPIO pins
 - Redirects 22 RTC input/output signals to RTC system

For details, see [ESP32-S3 Technical Reference Manual](#) > Chapter *IO MUX and GPIO Matrix*.

4.1.3.2 Reset

ESP32-S3 provides four reset levels, namely CPU Reset, Core Reset, System Reset, and Chip Reset.

Feature List

- Support four reset levels:
 - CPU Reset: only resets CPU x core. CPU x can be CPU0 or CPU1 here. Once such reset is released, programs will be executed from CPU x reset vector. Each CPU core has its own reset logic. If CPU Reset is from CPU0, the [sensitive registers](#) will be reset, too.
 - Core Reset: resets the whole digital system except RTC, including CPU0, CPU1, peripherals, Wi-Fi, Bluetooth[®] LE (BLE), and digital GPIOs.
 - System Reset: resets the whole digital system, including RTC.
 - Chip Reset: resets the whole chip.
- Support software reset and hardware reset:

- Software reset is triggered by CPU_x configuring its corresponding registers. Refer to [ESP32-S3 Technical Reference Manual](#) > Chapter *Low-power Management* for more details.
- Hardware reset is directly triggered by the circuit.

For details, see [ESP32-S3 Technical Reference Manual](#) > Chapter *Reset and Clock*.

4.1.3.3 Clock

CPU Clock

The CPU clock has three possible sources:

- External main crystal clock
- Internal fast RC oscillator (typically about 17.5 MHz, adjustable)
- PLL clock

The application can select the clock source from the three clocks above. The selected clock source drives the CPU clock directly, or after division, depending on the application. Once the CPU is reset, the default clock source would be the external main crystal clock divided by 2.

Note:

ESP32-S3 is unable to operate without an external main crystal clock.

RTC Clock

The RTC slow clock is used for RTC counter, RTC watchdog and low-power controller. It has three possible sources:

- External low-speed (32 kHz) crystal clock
- Internal slow RC oscillator (typically about 136 kHz, adjustable)
- Internal fast RC oscillator divided clock (derived from the internal fast RC oscillator divided by 256)

The RTC fast clock is used for RTC peripherals and sensor controllers. It has two possible sources:

- External main crystal clock divided by 2
- Internal fast RC oscillator (typically about 17.5 MHz, adjustable)

For details, see [ESP32-S3 Technical Reference Manual](#) > Chapter *Reset and Clock*.

4.1.3.4 Interrupt Matrix

The interrupt matrix embedded in ESP32-S3 independently allocates peripheral interrupt sources to the two CPUs' peripheral interrupts, to timely inform CPU0 or CPU1 to process the interrupts once the interrupt signals are generated.

Feature List

- 99 peripheral interrupt sources as input

- Generate 26 peripheral interrupts to CPU0 and 26 peripheral interrupts to CPU1 as output.

Note that the remaining six CPU0 interrupts and six CPU1 interrupts are internal interrupts.

- Disable CPU non-maskable interrupt (NMI) sources
- Query current interrupt status of peripheral interrupt sources

For details, see [ESP32-S3 Technical Reference Manual](#) > Chapter *Interrupt Matrix*.

4.1.3.5 Power Management Unit (PMU)

ESP32-S3 has an advanced Power Management Unit (PMU). It can be flexibly configured to power up different power domains of the chip to achieve the best balance between chip performance, power consumption, and wakeup latency.

The integrated Ultra-Low-Power (ULP) coprocessors allow ESP32-S3 to operate in Deep-sleep mode with most of the power domains turned off, thus achieving extremely low-power consumption.

Configuring the PMU is a complex procedure. To simplify power management for typical scenarios, there are the following **predefined power modes** that power up different combinations of power domains:

- **Active mode** – The CPU, RF circuits, and all peripherals are on. The chip can process data, receive, transmit, and listen.
- **Modem-sleep mode** – The CPU is on, but the clock frequency can be reduced. The wireless connections can be configured to remain active as RF circuits are periodically switched on when required.
- **Light-sleep mode** – The CPU stops running, and can be optionally powered on. The RTC peripherals, as well as the ULP coprocessor can be woken up periodically by the timer. The chip can be woken up via all wake up mechanisms: MAC, RTC timer, or external interrupts. Wireless connections can remain active. Some groups of digital peripherals can be optionally powered off.
- **Deep-sleep mode** – Only RTC is powered on. Wireless connection data is stored in RTC memory.

For power consumption in different power modes, see Section [5.6 Current Consumption](#).

Figure [4-2 Components and Power Domains](#) and the following Table [4-1](#) show the distribution of chip components between **power domains** and **power subdomains**.

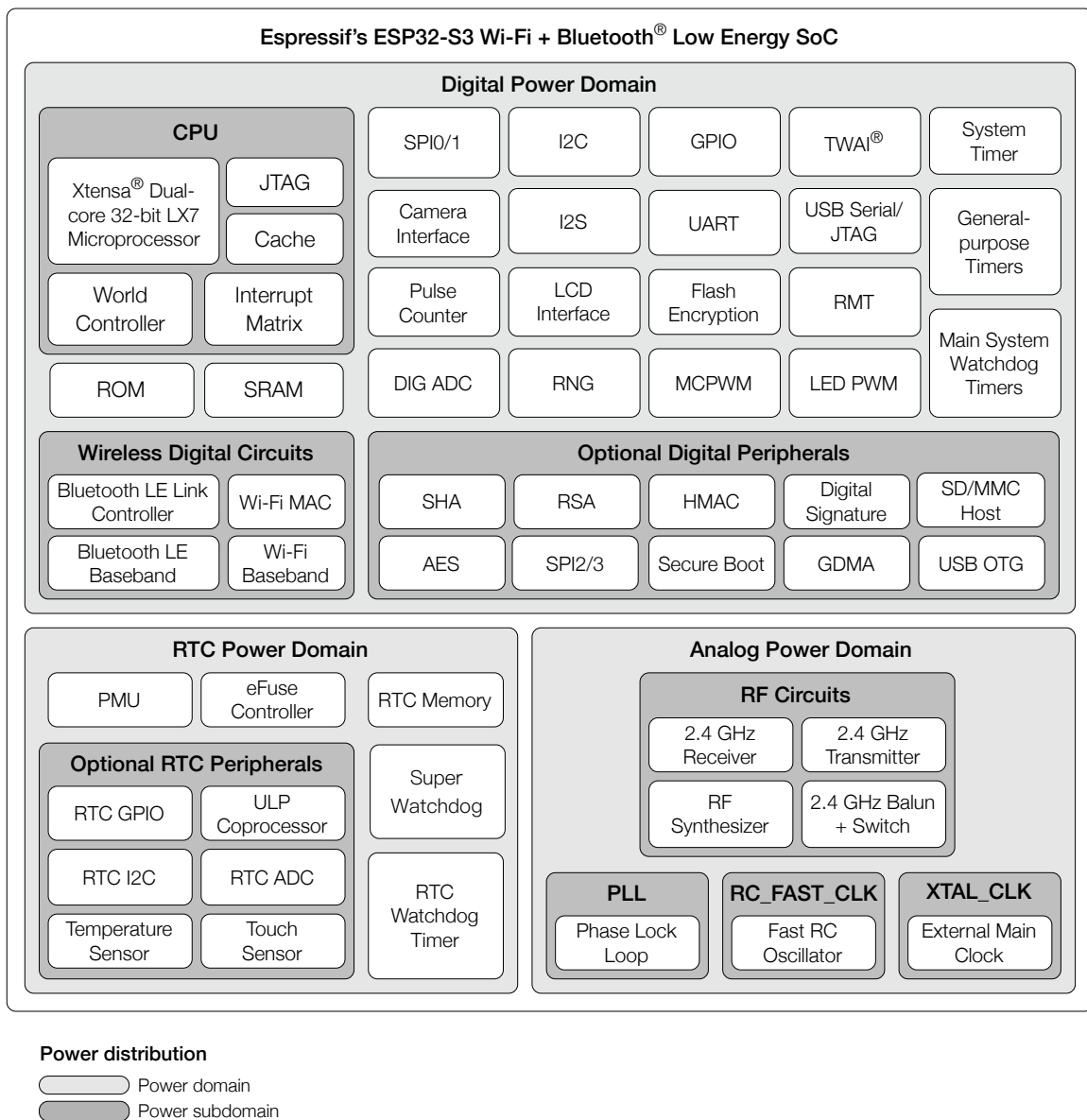

Figure 4-2. Components and Power Domains

Table 4-1. Components and Power Domains

Power Domain / Power Mode	RTC		Digital				Analog				
	RTC	Optional RTC Periph		CPU	Optional Digital Periph	Wireless Digital Circuits		RC_FAST_CLK	XTAL_CLK	PLL	RF Circuits
Active	ON	ON	ON	ON	ON	ON	ON	ON	ON	ON	ON
Modem-sleep	ON	ON	ON	ON	ON	ON ¹	ON	ON	ON	ON	OFF ²
Light-sleep	ON	ON	ON	OFF ¹	ON ¹	OFF ¹	ON	OFF	OFF	OFF	OFF ²
Deep-sleep	ON	ON ¹	OFF	OFF	OFF	OFF	ON	OFF	OFF	OFF	OFF

¹ Configurable. See [ESP32-S3 Technical Reference Manual](#) > Chapter *Low-power Management* for more details.

² If Wireless Digital Circuits are on, RF circuits are periodically switched on when required by internal operation to keep active wireless connections running.

4.1.3.6 System Timer

ESP32-S3 integrates a 52-bit system timer, which has two 52-bit counters and three comparators.

Feature List

- Counters with a clock frequency of 16 MHz
- Three types of independent interrupts generated according to alarm value
- Two alarm modes: target mode and period mode
- 52-bit target alarm value and 26-bit periodic alarm value
- Read sleep time from RTC timer when the chip is awoken from Deep-sleep or Light-sleep mode
- Counters can be stalled if the CPU is stalled or in OCD mode

For details, see [ESP32-S3 Technical Reference Manual](#) > Chapter *System Timer*.

4.1.3.7 General Purpose Timers

ESP32-S3 is embedded with four 54-bit general-purpose timers, which are based on 16-bit prescalers and 54-bit auto-reload-capable up/down-timers.

Feature List

- 16-bit clock prescaler, from 2 to 65536
- 54-bit time-base counter programmable to be incrementing or decrementing
- Able to read real-time value of the time-base counter
- Halting and resuming the time-base counter
- Programmable alarm generation
- Timer value reload (Auto-reload at alarm or software-controlled instant reload)
- Level interrupt generation

For details, see [ESP32-S3 Technical Reference Manual](#) > Chapter *Timer Group*.

4.1.3.8 Watchdog Timers

ESP32-S3 contains three watchdog timers: one in each of the two timer groups (called Main System Watchdog Timers, or MWDT) and one in the RTC Module (called the RTC Watchdog Timer, or RWDT).

During the flash boot process, RWDT and the first MWDT are enabled automatically in order to detect and recover from booting errors.

Feature List

- Four stages:
 - Each with a programmable timeout value
 - Each stage can be configured, enabled and disabled separately

- Upon expiry of each stage:
 - Interrupt, CPU reset, or core reset occurs for MWDT
 - Interrupt, CPU reset, core reset, or system reset occurs for RWDT
- 32-bit expiry counter
- Write protection, to prevent RWDT and MWDT configuration from being altered inadvertently
- Flash boot protection: If the boot process from an SPI flash does not complete within a predetermined period of time, the watchdog will reboot the entire main system

For details, see [ESP32-S3 Technical Reference Manual](#) > Chapter *Watchdog Timers*.

4.1.3.9 XTAL32K Watchdog Timers

Interrupt and Wake-Up

When the XTAL32K watchdog timer detects the oscillation failure of XTAL32K_CLK, an oscillation failure interrupt RTC_XTAL32K_DEAD_INT (for interrupt description, please refer to [ESP32-S3 Technical Reference Manual](#) > Chapter *Low-power Management*) is generated. At this point, the CPU will be woken up if in Light-sleep mode or Deep-sleep mode.

BACKUP32K_CLK

Once the XTAL32K watchdog timer detects the oscillation failure of XTAL32K_CLK, it replaces XTAL32K_CLK with BACKUP32K_CLK (with a frequency of 32 kHz or so) derived from RTC_CLK as RTC's SLOW_CLK, so as to ensure proper functioning of the system.

For details, see [ESP32-S3 Technical Reference Manual](#) > Chapter *XTAL32K Watchdog Timers*.

4.1.3.10 Permission Control

In ESP32-S3, the Permission Control module is used to control access to the slaves (including internal memory, peripherals, external flash, and RAM). The host can access its slave only if it has the right permission. In this way, data and instructions are protected from illegitimate read or write.

The ESP32-S3 CPU can run in both Secure World and Non-secure World where independent permission controls are adopted. The Permission Control module is able to identify which World the host is running and then proceed with its normal operations.

Feature List

- Manage access to internal memory by:
 - CPU
 - CPU trace module
 - GDMA
- Manage access to external flash and RAM by:
 - MMU
 - SPI1

- GDMA
- CPU through Cache
- Manage access to peripherals, supporting
 - independent permission control for each peripheral
 - monitoring non-aligned access
 - access control for customized address range
- Integrate permission lock register
 - All permission registers can be locked with the permission lock register. Once locked, the permission register and the lock register cannot be modified, unless the CPU is reset.
- Integrate permission monitor interrupt
 - In case of illegitimate access, the permission monitor interrupt will be triggered and the CPU will be informed to handle the interrupt.

For details, see [ESP32-S3 Technical Reference Manual](#) > Chapter *Permission Control*.

4.1.3.11 World Controller

ESP32-S3 can divide the hardware and software resources into a Secure World and a Non-Secure World to prevent sabotage or access to device information. Switching between the two worlds is performed by the World Controller.

Feature List

- Control of the CPU switching between secure and non-secure worlds
- Control of 15 DMA peripherals switching between secure and non-secure worlds
- Record of CPU's world switching logs
- Shielding of the CPU's NMI interrupt

For details, see [ESP32-S3 Technical Reference Manual](#) > Chapter *World Controller*.

4.1.3.12 System Registers

ESP32-S3 system registers can be used to control the following peripheral blocks and core modules:

- System and memory
- Clock
- Software Interrupt
- Low-power management
- Peripheral clock gating and reset
- CPU Control

For details, see [ESP32-S3 Technical Reference Manual](#) > Chapter *System Registers*.

4.1.4 Cryptography and Security Component

This subsection describes the security features incorporated into the chip, which safeguard data and operations.

4.1.4.1 SHA Accelerator

ESP32-S3 integrates an SHA accelerator, which is a hardware device that speeds up SHA algorithm significantly.

Feature List

- All the hash algorithms introduced in [FIPS PUB 180-4 Spec.](#)
 - SHA-1
 - SHA-224
 - SHA-256
 - SHA-384
 - SHA-512
 - SHA-512/224
 - SHA-512/256
 - SHA-512/t
- Two working modes
 - Typical SHA
 - DMA-SHA
- interleaved function when working in Typical SHA working mode
- Interrupt function when working in DMA-SHA working mode

For details, see [ESP32-S3 Technical Reference Manual](#) > Chapter *SHA Accelerator*.

4.1.4.2 AES Accelerator

ESP32-S3 integrates an Advanced Encryption Standard (AES) Accelerator, which is a hardware device that speeds up AES algorithm significantly.

Feature List

- Typical AES working mode
 - AES-128/AES-256 encryption and decryption
- DMA-AES working mode
 - AES-128/AES-256 encryption and decryption
 - Block cipher mode
 - * ECB (Electronic Codebook)

- * CBC (Cipher Block Chaining)
 - * OFB (Output Feedback)
 - * CTR (Counter)
 - * CFB8 (8-bit Cipher Feedback)
 - * CFB128 (128-bit Cipher Feedback)
- Interrupt on completion of computation

For details, see [ESP32-S3 Technical Reference Manual](#) > Chapter *AES Accelerator*.

4.1.4.3 RSA Accelerator

The RSA Accelerator provides hardware support for high precision computation used in various RSA asymmetric cipher algorithms.

Feature List

- Large-number modular exponentiation with two optional acceleration options
- Large-number modular multiplication, up to 4096 bits
- Large-number multiplication, with operands up to 2048 bits
- Operands of different lengths
- Interrupt on completion of computation

For details, see [ESP32-S3 Technical Reference Manual](#) > Chapter *RSA Accelerator*.

4.1.4.4 Secure Boot

Secure Boot feature uses a hardware root of trust to ensure only signed firmware (with RSA-PSS signature) can be booted.

4.1.4.5 HMAC Accelerator

The Hash-based Message Authentication Code (HMAC) module computes Message Authentication Codes (MACs) using Hash algorithm and keys as described in RFC 2104.

Feature List

- Standard HMAC-SHA-256 algorithm
- Hash result only accessible by configurable hardware peripheral (in downstream mode)
- Compatible to challenge-response authentication algorithm
- Generates required keys for the Digital Signature (DS) peripheral (in downstream mode)
- Re-enables soft-disabled JTAG (in downstream mode)

For details, see [ESP32-S3 Technical Reference Manual](#) > Chapter *HMAC Accelerator*.

4.1.4.6 Digital Signature

A Digital Signature is used to verify the authenticity and integrity of a message using a cryptographic algorithm.

Feature List

- RSA Digital Signatures with key length up to 4096 bits
- Encrypted private key data, only decryptable by DS peripheral
- SHA-256 digest to protect private key data against tampering by an attacker

For details, see [ESP32-S3 Technical Reference Manual](#) > Chapter *Digital Signature*.

4.1.4.7 External Memory Encryption and Decryption

ESP32-S3 integrates an External Memory Encryption and Decryption module that complies with the XTS-AES standard.

Feature List

- General XTS-AES algorithm, compliant with IEEE Std 1619-2007
- Software-based manual encryption
- High-speed auto encryption, without software's participation
- High-speed auto decryption, without software's participation
- Encryption and decryption functions jointly determined by registers configuration, eFuse parameters, and boot mode

For details, see [ESP32-S3 Technical Reference Manual](#) > Chapter *External Memory Encryption and Decryption*.

4.1.4.8 Clock Glitch Detection

The Clock Glitch Detection module on ESP32-S3 monitors input clock signals from XTAL_CLK. If it detects a glitch with a width shorter than 3 ns, input clock signals from XTAL_CLK are blocked.

For details, see [ESP32-S3 Technical Reference Manual](#) > Chapter *Clock Glitch Detection*.

4.1.4.9 Random Number Generator

The random number generator (RNG) in ESP32-S3 generates true random numbers, which means random number generated from a physical process, rather than by means of an algorithm. No number generated within the specified range is more or less likely to appear than any other number.

For details, see [ESP32-S3 Technical Reference Manual](#) > Chapter *Random Number Generator*.

4.2 Peripherals

This section describes the chip's peripheral capabilities, covering connectivity interfaces and on-chip sensors that extend its functionality.

4.2.1 Connectivity Interface

This subsection describes the connectivity interfaces on the chip that enable communication and interaction with external devices and networks.

4.2.1.1 UART Controller

ESP32-S3 has three UART (Universal Asynchronous Receiver Transmitter) controllers, i.e., UART0, UART1, and UART2, which support IrDA and asynchronous communication (RS232 and RS485) at a speed of up to 5 Mbps.

Feature List

- Three clock sources that can be divided
- Programmable baud rate
- 1024 x 8-bit RAM shared by TX FIFOs and RX FIFOs of the three UART controllers
- Full-duplex asynchronous communication
- Automatic baud rate detection of input signals
- Data bits ranging from 5 to 8
- Stop bits of 1, 1.5, 2, or 3 bits
- Parity bit
- Special character AT_CMD detection
- RS485 protocol
- IrDA protocol
- High-speed data communication using GDMA
- UART as wake-up source
- Software and hardware flow control

For details, see [ESP32-S3 Technical Reference Manual](#) > Chapter *UART Controller*.

Pin Assignment

- UART0
 - The pins U0TXD and U0RXD that are connected to transmit and receive signals are multiplexed with GPIO43 ~ GPIO44 via IO MUX, and can also be connected to any GPIO via the GPIO Matrix.
 - The pins U0RTS and U0CTS that are connected to hardware flow control signals are multiplexed with GPIO15 ~ GPIO16, RTC_GPIO15 ~ RTC_GPIO16, XTAL_32K_P and XTAL_32K_N, and SAR ADC2 interface via IO MUX, and can also be connected to any GPIO via the GPIO Matrix.

- The pins UODTR and UODSR that are connected to hardware flow control signals can be chosen from any GPIO via the GPIO Matrix.
- UART1
 - The pins U1TXD and U1RXD that are connected to transmit and receive signals are multiplexed with GPIO17 ~ GPIO18, RTC_GPIO17 ~ RTC_GPIO18, and SAR ADC2 interface via IO MUX, and can also be connected to any GPIO via the GPIO Matrix.
 - The pins U1RTS and U1CTS that are connected to hardware flow control signals are multiplexed with GPIO19 ~ GPIO20, RTC_GPIO19 ~ RTC_GPIO20, USB_D- and USB_D+ pins, and SAR ADC2 interface via IO MUX, and can also be connected to any GPIO via the GPIO Matrix.
 - The pins U1DTR and U1DSR that are connected to hardware flow control signals can be chosen from any GPIO via the GPIO Matrix.
- UART2: The pins used can be chosen from any GPIO via the GPIO Matrix.

For more information about the pin assignment, see Section [2.3 IO Pins](#) and [ESP32-S3 Technical Reference Manual](#) > Chapter *IO MUX and GPIO Matrix*.

4.2.1.2 I2C Interface

ESP32-S3 has two I2C bus interfaces which are used for I2C master mode or slave mode, depending on the user's configuration.

Feature List

- Standard mode (100 kbit/s)
- Fast mode (400 kbit/s)
- Up to 800 kbit/s (constrained by SCL and SDA pull-up strength)
- 7-bit and 10-bit addressing mode
- Double addressing mode (slave addressing and slave register addressing)

The hardware provides a command abstraction layer to simplify the usage of the I2C peripheral.

For details, see [ESP32-S3 Technical Reference Manual](#) > Chapter *I2C Controller*.

Pin Assignment

For I2C, the pins used can be chosen from any GPIOs via the GPIO Matrix.

For more information about the pin assignment, see Section [2.3 IO Pins](#) and [ESP32-S3 Technical Reference Manual](#) > Chapter *IO MUX and GPIO Matrix*.

4.2.1.3 I2S Interface

ESP32-S3 includes two standard I2S interfaces. They can operate in master mode or slave mode, in full-duplex mode or half-duplex communication mode, and can be configured to operate with an 8-bit, 16-bit, 24-bit, or 32-bit resolution as an input or output channel. BCK clock frequency, from 10 kHz up to 40 MHz, is supported.

The I2S interface has a dedicated DMA controller. It supports TDM PCM, TDM MSB alignment, TDM LSB alignment, TDM Phillips, and PDM interface.

Pin Assignment

For I2S, the pins used can be chosen from any GPIOs via the GPIO Matrix.

For more information about the pin assignment, see Section [2.3 IO Pins](#) and [ESP32-S3 Technical Reference Manual](#) > Chapter *IO MUX and GPIO Matrix*.

4.2.1.4 LCD and Camera Controller

The LCD and Camera controller of ESP32-S3 consists of a LCD module and a camera module.

The LCD module is designed to send parallel video data signals, and its bus supports 8-bit ~ 16-bit parallel RGB, I8080, and MOTO6800 interfaces. These interfaces operate at 40 MHz or lower, and support conversion among RGB565, YUV422, YUV420, and YUV411.

The camera module is designed to receive parallel video data signals, and its bus supports an 8-bit ~ 16-bit DVP image sensor, with clock frequency of up to 40 MHz. The camera interface supports conversion among RGB565, YUV422, YUV420, and YUV411.

Pin Assignment

For LCD and Camera controller, the pins used can be chosen from any GPIOs via the GPIO Matrix.

For more information about the pin assignment, see Section [2.3 IO Pins](#) and [ESP32-S3 Technical Reference Manual](#) > Chapter *IO MUX and GPIO Matrix*.

4.2.1.5 Serial Peripheral Interface (SPI)

ESP32-S3 has the following SPI interfaces:

- **SPI0** used by ESP32-S3's GDMA controller and cache to access in-package or off-package flash/PSRAM
- **SPI1** used by the CPU to access in-package or off-package flash/PSRAM
- **SPI2** is a general purpose SPI controller with access to a DMA channel allocated by the GDMA controller
- **SPI3** is a general purpose SPI controller with access to a DMA channel allocated by the GDMA controller

Feature List

- SPI0 and SPI1:
 - Supports Single SPI, Dual SPI, Quad SPI, Octal SPI, QPI, and OPI modes
 - 8-line SPI mode supports single data rate (SDR) and double data rate (DDR)
 - Configurable clock frequency with a maximum of 120 MHz for 8-line SPI SDR/DDR modes
 - Data transmission is in bytes
- SPI2:
 - Supports operation as a master or slave

- Connects to a DMA channel allocated by the GDMA controller
 - Supports Single SPI, Dual SPI, Quad SPI, Octal SPI, QPI, and OPI modes
 - Configurable clock polarity (CPOL) and phase (CPHA)
 - Configurable clock frequency
 - Data transmission is in bytes
 - Configurable read and write data bit order: most-significant bit (MSB) first, or least-significant bit (LSB) first
 - As a master
 - * Supports 2-line full-duplex communication with clock frequency up to 80 MHz
 - * Full-duplex 8-line SPI mode supports single data rate (SDR) only
 - * Supports 1-, 2-, 4-, 8-line half-duplex communication with clock frequency up to 80 MHz
 - * Half-duplex 8-line SPI mode supports both single data rate (up to 80 MHz) and double data rate (up to 40 MHz)
 - * Provides six SPI_CS pins for connection with six independent SPI slaves
 - * Configurable CS setup time and hold time
 - As a slave
 - * Supports 2-line full-duplex communication with clock frequency up to 60 MHz
 - * Supports 1-, 2-, 4-line half-duplex communication with clock frequency up to 60 MHz
 - * Full-duplex and half-duplex 8-line SPI mode supports single data rate (SDR) only
- SPI3:
 - Supports operation as a master or slave
 - Connects to a DMA channel allocated by the GDMA controller
 - Supports Single SPI, Dual SPI, Quad SPI, and QPI modes
 - Configurable clock polarity (CPOL) and phase (CPHA)
 - Configurable clock frequency
 - Data transmission is in bytes
 - Configurable read and write data bit order: most-significant bit (MSB) first, or least-significant bit (LSB) first
 - As a master
 - * Supports 2-line full-duplex communication with clock frequency up to 80 MHz
 - * Supports 1-, 2-, 4-line half-duplex communication with clock frequency up to 80 MHz
 - * Provides three SPI_CS pins for connection with three independent SPI slaves
 - * Configurable CS setup time and hold time
 - As a slave

- * Supports 2-line full-duplex communication with clock frequency up to 60 MHz
- * Supports 1-, 2-, 4-line half-duplex communication with clock frequency up to 60 MHz

For details, see [ESP32-S3 Technical Reference Manual](#) > Chapter *SPI Controller*.

Pin Assignment

- SPI0/1
 - Via IO MUX:
 - * Interface *4a* (see Table 2-4) is multiplexed with GPIO26 ~ GPIO32 via IO MUX. When used in conjunction with *4b*, it can operate as the lower 4 bits data line interface and the CLK, CS0, and CS1 interfaces in 8-line SPI mode.
 - * Interface *4b* (see Table 2-4) is multiplexed with GPIO33 ~ GPIO37 and SPI interfaces *4e* and *4f* via IO MUX. When used in conjunction with *4a*, it can operate as the higher 4 bits data line interface and DQS interface in 8-line SPI mode.
 - * Interface *4d* (see Table 2-4) is multiplexed with GPIO8 ~ GPIO14, RTC_GPIO8 ~ RTC_GPIO14, Touch Sensor interface, SAR ADC interface, and SPI interfaces *4c* and *4g* via IO MUX. Note that the fast SPI2 interface will not be available.
 - * Interface *4e* (see Table 2-4) is multiplexed with GPIO33 ~ GPIO39, JTAG MTCK interface, and SPI interfaces *4b* and *4f* via IO MUX. It is an alternative group of signal lines that can be used if SPI0/1 does not use 8-line SPI connection.
 - Via GPIO Matrix: The pins used can be chosen from any GPIOs via the GPIO Matrix.
- SPI2
 - Via IO MUX:
 - * Interface *4c* (see Table 2-4) is multiplexed with GPIO9 ~ GPIO14, RTC_GPIO9 ~ RTC_GPIO14, Touch Sensor interface, SAR ADC interface, and SPI interfaces *4d* and *4g* via IO MUX. It is the SPI2 main interface for fast SPI connection.
 - * (not recommended) Interface *4f* (see Table 2-4) is multiplexed with GPIO33 ~ GPIO38, SPI interfaces *4e* and *4b* via IO MUX. It is the alternative SPI2 interface if the main SPI2 is not available. Its performance is comparable to SPI2 via GPIO matrix, so use the GPIO matrix instead.
 - * (not recommended) Interface *4g* (see Table 2-4) is multiplexed with GPIO10 ~ GPIO14, RTC_GPIO10 ~ RTC_GPIO14, Touch Sensor interface, SAR ADC interface, and SPI interfaces *4c* and *4d* via IO MUX. It is the alternative SPI2 interface signal lines for 8-line SPI connection.
 - Via GPIO Matrix: The pins used can be chosen from any GPIOs via the GPIO Matrix.
- SPI3: The pins used can be chosen from any GPIOs via the GPIO Matrix.

For more information about the pin assignment, see Section 2.3 *IO Pins* and [ESP32-S3 Technical Reference Manual](#) > Chapter *IO MUX and GPIO Matrix*.

4.2.1.6 Two-Wire Automotive Interface (TWAI®)

The Two-Wire Automotive Interface (TWAI®) is a multi-master, multi-cast communication protocol with error detection and signaling as well as inbuilt message priorities and arbitration.

Feature List

- Compatible with ISO 11898-1 protocol (CAN Specification 2.0)
- Standard frame format (11-bit ID) and extended frame format (29-bit ID)
- Bit rates from 1 Kbit/s to 1 Mbit/s
- Multiple modes of operation:
 - Normal
 - Listen Only
 - Self-Test (no acknowledgment required)
- 64-byte receive FIFO
- Acceptance filter (single and dual filter modes)
- Error detection and handling:
 - Error counters
 - Configurable error interrupt threshold
 - Error code capture
 - Arbitration lost capture

For details, see [ESP32-S3 Technical Reference Manual](#) > Chapter *Two-wire Automotive Interface*.

Pin Assignment

For TWAI, the pins used can be chosen from any GPIOs via the GPIO Matrix.

For more information about the pin assignment, see Section [2.3 IO Pins](#) and [ESP32-S3 Technical Reference Manual](#) > Chapter *IO MUX and GPIO Matrix*.

4.2.1.7 USB 2.0 OTG Full-Speed Interface

ESP32-S3 features a full-speed USB OTG interface along with an integrated transceiver. The USB OTG interface complies with the USB 2.0 specification.

General Features

- FS and LS data rates
- HNP and SRP as A-device or B-device
- Dynamic FIFO (DFIFO) sizing
- Multiple modes of memory access

- Scatter/Gather DMA mode
- Buffer DMA mode
- Slave mode
- Can choose integrated transceiver or external transceiver
- Utilizing integrated transceiver with USB Serial/JTAG by time-division multiplexing when only integrated transceiver is used
- Support USB OTG using one of the transceivers while USB Serial/JTAG using the other one when both integrated transceiver or external transceiver are used

Device Mode Features

- Endpoint number 0 always present (bi-directional, consisting of EPO IN and EPO OUT)
- Six additional endpoints (endpoint numbers 1 to 6), configurable as IN or OUT
- Maximum of five IN endpoints concurrently active at any time (including EPO IN)
- All OUT endpoints share a single RX FIFO
- Each IN endpoint has a dedicated TX FIFO

Host Mode Features

- Eight channels (pipes)
 - A control pipe consists of two channels (IN and OUT), as IN and OUT transactions must be handled separately. Only Control transfer type is supported.
 - Each of the other seven channels is dynamically configurable to be IN or OUT, and supports Bulk, Isochronous, and Interrupt transfer types.
- All channels share an RX FIFO, non-periodic TX FIFO, and periodic TX FIFO. The size of each FIFO is configurable.

For details, see [ESP32-S3 Technical Reference Manual](#) > Chapter *USB On-The-Go*.

Pin Assignment

When using the on-chip PHY, the differential signal pins USB_D- and USB_D+ of the USB OTG are multiplexed with GPIO19 ~ GPIO20, RTC_GPIO19 ~ RTC_GPIO20, UART1 interface, and SAR ADC2 interface via IO MUX.

When using external PHY, the USB OTG pins are multiplexed with GPIO21, RTC_GPIO21, GPIO38 ~ GPIO42, and SPI interface via IO MUX:

- VP signal connected to MTMS pin
- VM signal connected to MTDI pin
- RCV signal connected to GPIO21
- OEN signal connected to MTDO pin
- VPO signal connected to MTCK pin

- VMO signal connected to GPIO38

For more information about the pin assignment, see Section [2.3 IO Pins](#) and [ESP32-S3 Technical Reference Manual](#) > Chapter *IO MUX and GPIO Matrix*.

4.2.1.8 USB Serial/JTAG Controller

ESP32-S3 integrates a USB Serial/JTAG controller.

Feature List

- USB Full-speed device.
- Can be configured to either use internal USB PHY of ESP32-S3 or external PHY via GPIO matrix.
- Fixed function device, hardwired for CDC-ACM (Communication Device Class - Abstract Control Model) and JTAG adapter functionality.
- Two OUT Endpoints, three IN Endpoints in addition to Control Endpoint 0; Up to 64-byte data payload size.
- Internal PHY, so no or very few external components needed to connect to a host computer.
- CDC-ACM adherent serial port emulation is plug-and-play on most modern OSes.
- JTAG interface allows fast communication with CPU debug core using a compact representation of JTAG instructions.
- CDC-ACM supports host controllable chip reset and entry into download mode.

For details, see [ESP32-S3 Technical Reference Manual](#) > Chapter *USB Serial/JTAG Controller*.

Pin Assignment

When using the on-chip PHY, the differential signal pins USB_D- and USB_D+ of the USB Serial/JTAG controller are multiplexed with GPIO19 ~ GPIO20, RTC_GPIO19 ~ RTC_GPIO20, UART1 interface, and SAR ADC2 interface via IO MUX.

When using external PHY, the USB Serial/JTAG controller pins are multiplexed with GPIO38 ~ GPIO42 and SPI interface via IO MUX:

- VP signal connected to MTMS pin
- VM signal connected to MTDI pin
- OEN signal connected to MTDO pin
- VPO signal connected to MTCK pin
- VMO signal connected to GPIO38

For more information about the pin assignment, see Section [2.3 IO Pins](#) and [ESP32-S3 Technical Reference Manual](#) > Chapter *IO MUX and GPIO Matrix*.

4.2.1.9 SD/MMC Host Controller

ESP32-S3 has an SD/MMC Host controller.

Feature List

- Secure Digital (SD) memory version 3.0 and version 3.01
- Secure Digital I/O (SDIO) version 3.0
- Consumer Electronics Advanced Transport Architecture (CE-ATA) version 1.1
- Multimedia Cards (MMC version 4.41, eMMC version 4.5 and version 4.51)
- Up to 80 MHz clock output
- Three data bus modes:
 - 1-bit
 - 4-bit (supports two SD/SDIO/MMC 4.41 cards, and one SD card operating at 1.8 V in 4-bit mode)
 - 8-bit

For details, see [ESP32-S3 Technical Reference Manual](#) > Chapter *SD/MMC Host Controller*.

Pin Assignment

For SD/MMC Host, the pins used can be chosen from any GPIOs via the GPIO Matrix.

For more information about the pin assignment, see Section [2.3 IO Pins](#) and [ESP32-S3 Technical Reference Manual](#) > Chapter *IO MUX and GPIO Matrix*.

4.2.1.10 LED PWM Controller

The LED PWM controller can generate independent digital waveforms on eight channels.

Feature List

- Can generate a digital waveform with configurable periods and duty cycle. The duty cycle resolution can be up to 14 bits within a 1 ms period
- Multiple clock sources, including APB clock and external main crystal clock
- Can operate when the CPU is in Light-sleep mode
- Gradual increase or decrease of duty cycle, useful for the LED RGB color-fading generator

For details, see [ESP32-S3 Technical Reference Manual](#) > Chapter *LED PWM Controller*.

Pin Assignment

For LED PWM, the pins used can be chosen from any GPIOs via the GPIO Matrix.

For more information about the pin assignment, see Section [2.3 IO Pins](#) and [ESP32-S3 Technical Reference Manual](#) > Chapter *IO MUX and GPIO Matrix*.

4.2.1.11 Motor Control PWM (MCPWM)

ESP32-S3 integrates two MCPWMs that can be used to drive digital motors and smart light. Each MCPWM peripheral has one clock divider (prescaler), three PWM timers, three PWM operators, and a capture module.

PWM timers are used for generating timing references. The PWM operators generate desired waveform based on the timing references. Any PWM operator can be configured to use the timing references of any PWM timers. Different PWM operators can use the same PWM timer's timing references to produce related PWM signals. PWM operators can also use different PWM timers' values to produce the PWM signals that work alone. Different PWM timers can also be synchronized together.

For details, see [ESP32-S3 Technical Reference Manual](#) > Chapter *Motor Control PWM*.

Pin Assignment

For MCPWM, the pins used can be chosen from any GPIOs via the GPIO Matrix.

For more information about the pin assignment, see Section [2.3 IO Pins](#) and [ESP32-S3 Technical Reference Manual](#) > Chapter *IO MUX and GPIO Matrix*.

4.2.1.12 Remote Control Peripheral (RMT)

The Remote Control Peripheral (RMT) is designed to send and receive infrared remote control signals.

Feature List

- Four TX channels
- Four RX channels
- Support multiple channels (programmable) transmitting data simultaneously
- Eight channels share a 384 x 32-bit RAM
- Support modulation on TX pulses
- Support filtering and demodulation on RX pulses
- Wrap TX mode
- Wrap RX mode
- Continuous TX mode
- DMA access for TX mode on channel 3
- DMA access for RX mode on channel 7

For details, see [ESP32-S3 Technical Reference Manual](#) > Chapter *Remote Control Peripheral*.

Pin Assignment

For RMT, the pins used can be chosen from any GPIOs via the GPIO Matrix.

For more information about the pin assignment, see Section [2.3 IO Pins](#) and [ESP32-S3 Technical Reference Manual](#) > Chapter *IO MUX and GPIO Matrix*.

4.2.1.13 Pulse Count Controller (PCNT)

The pulse count controller (PCNT) captures pulse and counts pulse edges through multiple modes.

Feature List

- Four independent pulse counters (units) that count from 1 to 65535
- Each unit consists of two independent channels sharing one pulse counter
- All channels have input pulse signals (e.g. `sig_ch0_un`) with their corresponding control signals (e.g. `ctrl_ch0_un`)
- Independently filter glitches of input pulse signals (`sig_ch0_un` and `sig_ch1_un`) and control signals (`ctrl_ch0_un` and `ctrl_ch1_un`) on each unit
- Each channel has the following parameters:
 1. Selection between counting on positive or negative edges of the input pulse signal
 2. Configuration to Increment, Decrement, or Disable counter mode for control signal's high and low states

For details, see [ESP32-S3 Technical Reference Manual](#) > Chapter *Pulse Count Controller*.

Pin Assignment

For pulse count controller, the pins used can be chosen from any GPIOs via the GPIO Matrix.

For more information about the pin assignment, see Section [2.3 IO Pins](#) and [ESP32-S3 Technical Reference Manual](#) > Chapter *IO MUX and GPIO Matrix*.

4.2.2 Analog Signal Processing

This subsection describes components on the chip that sense and process real-world data.

4.2.2.1 SAR ADC

ESP32-S3 integrates two 12-bit SAR ADCs and supports measurements on 20 channels (analog-enabled pins). For power-saving purpose, the ULP coprocessors in ESP32-S3 can also be used to measure voltage in sleep modes. By using threshold settings or other methods, we can awaken the CPU from sleep modes.

Note:

Please note that the ADC2_CH... analog functions (see Table [2-8 Analog Functions](#)) cannot be used with Wi-Fi simultaneously.

For more details, see [ESP32-S3 Technical Reference Manual](#) > Chapter *On-Chip Sensors and Analog Signal Processing*.

Pin Assignment

The pins for the SAR ADC are multiplexed with GPIO1 ~ GPIO20, RTC_GPIO1 ~ RTC_GPIO20, Touch Sensor interface, SPI interface, UART interface, and USB_D- and USB_D+ pins via IO MUX.

For more information about the pin assignment, see Section [2.3 IO Pins](#) and [ESP32-S3 Technical Reference Manual](#) > Chapter *IO MUX and GPIO Matrix*.

4.2.2.2 Temperature Sensor

The temperature sensor generates a voltage that varies with temperature. The voltage is internally converted via an ADC into a digital value.

The temperature sensor has a range of $-40\text{ }^{\circ}\text{C}$ to $125\text{ }^{\circ}\text{C}$. It is designed primarily to sense the temperature changes inside the chip. The temperature value depends on factors such as microcontroller clock frequency or I/O load. Generally, the chip's internal temperature is higher than the ambient temperature.

For more details, see [ESP32-S3 Technical Reference Manual](#) > Chapter *On-Chip Sensors and Analog Signal Processing*.

4.2.2.3 Touch Sensor

ESP32-S3 has 14 capacitive-sensing GPIOs, which detect variations induced by touching or approaching the GPIOs with a finger or other objects. The low-noise nature of the design and the high sensitivity of the circuit allow relatively small pads to be used. Arrays of pads can also be used, so that a larger area or more points can be detected. The touch sensing performance can be further enhanced by the waterproof design and digital filtering feature.

Note:

ESP32-S3 touch sensor has not passed the Conducted Susceptibility (CS) test for now, and thus has limited application scenarios.

For more details, see [ESP32-S3 Technical Reference Manual](#) > Chapter *On-Chip Sensors and Analog Signal Processing*.

Pin Assignment

The pins for touch sensor are multiplexed with GPIO1 ~ GPIO14, RTC_GPIO1 ~ RTC_GPIO14, SAR ADC interface, and SPI interface via IO MUX.

For more information about the pin assignment, see Section [2.3 IO Pins](#) and [ESP32-S3 Technical Reference Manual](#) > Chapter *IO MUX and GPIO Matrix*.

4.3 Wireless Communication

This section describes the chip's wireless communication capabilities, spanning radio technology, Wi-Fi, Bluetooth, and 802.15.4.

4.3.1 Radio

This subsection describes the fundamental radio technology embedded in the chip that facilitates wireless communication and data exchange.

4.3.1.1 2.4 GHz Receiver

The 2.4 GHz receiver demodulates the 2.4 GHz RF signal to quadrature baseband signals and converts them to the digital domain with two high-resolution, high-speed ADCs. To adapt to varying signal channel conditions, ESP32-S3 integrates RF filters, Automatic Gain Control (AGC), DC offset cancelation circuits, and baseband filters.

4.3.1.2 2.4 GHz Transmitter

The 2.4 GHz transmitter modulates the quadrature baseband signals to the 2.4 GHz RF signal, and drives the antenna with a high-powered CMOS power amplifier. The use of digital calibration further improves the linearity of the power amplifier.

To compensate for receiver imperfections, additional calibration methods are built into the chip, including:

- Carrier leakage compensation
- I/Q amplitude/phase matching
- Baseband nonlinearities suppression
- RF nonlinearities suppression
- Antenna matching

These built-in calibration routines reduce the cost and time to the market for your product, and eliminate the need for specialized testing equipment.

4.3.1.3 Clock Generator

The clock generator produces quadrature clock signals of 2.4 GHz for both the receiver and the transmitter. All components of the clock generator are integrated into the chip, including inductors, varactors, filters, regulators, and dividers.

The clock generator has built-in calibration and self-test circuits. Quadrature clock phases and phase noise are optimized on chip with patented calibration algorithms which ensure the best performance of the receiver and the transmitter.

4.3.2 Wi-Fi

This subsection describes the chip's Wi-Fi capabilities, which facilitate wireless communication at a high data rate.

4.3.2.1 Wi-Fi Radio and Baseband

The ESP32-S3 Wi-Fi radio and baseband support the following features:

- 802.11b/g/n
- 802.11n MCS0-7 that supports 20 MHz and 40 MHz bandwidth
- 802.11n MCS32
- 802.11n 0.4 μ s guard-interval
- Data rate up to 150 Mbps
- RX STBC (single spatial stream)
- Adjustable transmitting power
- Antenna diversity:
ESP32-S3 supports antenna diversity with an external RF switch. This switch is controlled by one or more GPIOs, and used to select the best antenna to minimize the effects of channel imperfections.

4.3.2.2 Wi-Fi MAC

ESP32-S3 implements the full 802.11b/g/n Wi-Fi MAC protocol. It supports the Basic Service Set (BSS) STA and SoftAP operations under the Distributed Control Function (DCF). Power management is handled automatically with minimal host interaction to minimize the active duty period.

The ESP32-S3 Wi-Fi MAC applies the following low-level protocol functions automatically:

- Four virtual Wi-Fi interfaces
- Simultaneous Infrastructure BSS Station mode, SoftAP mode, and Station + SoftAP mode
- RTS protection, CTS protection, Immediate Block ACK
- Fragmentation and defragmentation
- TX/RX A-MPDU, TX/RX A-MSDU
- TXOP
- WMM
- GCMP, CCMP, TKIP, WAPI, WEP, BIP, WPA2-PSK/WPA2-Enterprise, and WPA3-PSK/WPA3-Enterprise
- Automatic beacon monitoring (hardware TSF)
- 802.11mc FTM

4.3.2.3 Networking Features

Users are provided with libraries for TCP/IP networking, ESP-WIFI-MESH networking, and other networking protocols over Wi-Fi. TLS 1.2 support is also provided.

4.3.3 Bluetooth LE

This subsection describes the chip's Bluetooth capabilities, which facilitate wireless communication for low-power, short-range applications. ESP32-S3 includes a Bluetooth Low Energy subsystem that integrates a

hardware link layer controller, an RF/modem block and a feature-rich software protocol stack. It supports the core features of Bluetooth 5 and Bluetooth mesh.

4.3.3.1 Bluetooth LE PHY

Bluetooth Low Energy radio and PHY in ESP32-S3 support:

- 1 Mbps PHY
- 2 Mbps PHY for high transmission speed and high data throughput
- Coded PHY for high RX sensitivity and long range (125 Kbps and 500 Kbps)
- Class 1 transmit power without external PA
- HW Listen before talk (LBT)

4.3.3.2 Bluetooth LE Link Controller

Bluetooth Low Energy Link Layer Controller in ESP32-S3 supports:

- LE advertising extensions, to enhance broadcasting capacity and broadcast more intelligent data
- Multiple advertisement sets
- Simultaneous advertising and scanning
- Multiple connections in simultaneous central and peripheral roles
- Adaptive frequency hopping and channel assessment
- LE channel selection algorithm #2
- Connection parameter update
- High duty cycle non-connectable advertising
- LE privacy 1.2
- LE data packet length extension
- Link layer extended scanner filter policies
- Low duty cycle directed advertising
- Link layer encryption
- LE Ping

5 Electrical Characteristics

5.1 Absolute Maximum Ratings

Stresses above those listed in Table 5-1 *Absolute Maximum Ratings* may cause permanent damage to the device. These are stress ratings only and normal operation of the device at these or any other conditions beyond those indicated in Section 5.2 *Recommended Power Supply Characteristics* is not implied. Exposure to absolute-maximum-rated conditions for extended periods may affect device reliability.

Table 5-1. Absolute Maximum Ratings

Parameter	Description	Min	Max	Unit
Input power pins ¹	Allowed input voltage	-0.3	3.6	V
I_{output} ²	Cumulative IO output current	—	1500	mA
T_{STORE}	Storage temperature	-40	150	°C

¹ For more information on input power pins, see Section 2.5.1 *Power Pins*.

² The product proved to be fully functional after all its IO pins were pulled high while being connected to ground for 24 consecutive hours at ambient temperature of 25 °C.

5.2 Recommended Power Supply Characteristics

For recommended ambient temperature, see Section 1 *ESP32-S3 Series Comparison*.

Table 5-2. Recommended Power Characteristics

Parameter ¹	Description	Min	Typ	Max	Unit
VDDA, VDD3P3	Recommended input voltage	3.0	3.3	3.6	V
VDD3P3_RTC ²	Recommended input voltage	3.0	3.3	3.6	V
VDD_SPI (as input)	—	1.8	3.3	3.6	V
VDD3P3_CPU ³	Recommended input voltage	3.0	3.3	3.6	V
I_{VDD} ⁴	Cumulative input current	0.5	—	—	A

¹ See in conjunction with Section 2.5 *Power Supply*.

² If VDD3P3_RTC is used to power VDD_SPI (see Section 2.5.2 *Power Scheme*), the voltage drop on R_{SPI} should be accounted for. See also Section 5.3 *VDD_SPI Output Characteristics*.

³ If writing to eFuses, the voltage on VDD3P3_CPU should not exceed 3.3 V as the circuits responsible for burning eFuses are sensitive to higher voltages.

⁴ If you use a single power supply, the recommended output current is 500 mA or more.

5.3 VDD_SPI Output Characteristics

Table 5-3. VDD_SPI Internal and Output Characteristics

Parameter	Description ¹	Typ	Unit
R_{SPI}	VDD_SPI powered by VDD3P3_RTC via R_{SPI} for 3.3 V flash/PSRAM ²	14	Ω
I_{SPI}	Output current when VDD_SPI is powered by Flash Voltage Regulator for 1.8 V flash/PSRAM	40	mA

¹ See in conjunction with Section 2.5.2 *Power Scheme*.

² VDD3P3_RTC must be more than $VDD_{flash_min} + I_{flash_max} * R_{SPI}$;

where

- VDD_{flash_min} – minimum operating voltage of flash/PSRAM
- I_{flash_max} – maximum operating current of flash/PSRAM

5.4 DC Characteristics (3.3 V, 25 °C)

Table 5-4. DC Characteristics (3.3 V, 25 °C)

Parameter	Description	Min	Typ	Max	Unit
C_{IN}	Pin capacitance	—	2	—	pF
V_{IH}	High-level input voltage	$0.75 \times VDD^1$	—	$VDD^1 + 0.3$	V
V_{IL}	Low-level input voltage	-0.3	—	$0.25 \times VDD^1$	V
I_{IH}	High-level input current	—	—	50	nA
I_{IL}	Low-level input current	—	—	50	nA
V_{OH}^2	High-level output voltage	$0.8 \times VDD^1$	—	—	V
V_{OL}^2	Low-level output voltage	—	—	$0.1 \times VDD^1$	V
I_{OH}	High-level source current ($VDD^1 = 3.3$ V, $V_{OH} \geq 2.64$ V, PAD_DRIVER = 3)	—	40	—	mA
I_{OL}	Low-level sink current ($VDD^1 = 3.3$ V, $V_{OL} = 0.495$ V, PAD_DRIVER = 3)	—	28	—	mA
R_{PU}	Internal weak pull-up resistor	—	45	—	k Ω
R_{PD}	Internal weak pull-down resistor	—	45	—	k Ω
V_{IH_nRST}	Chip reset release voltage (CHIP_PU voltage is within the specified range)	$0.75 \times VDD^1$	—	$VDD^1 + 0.3$	V
V_{IL_nRST}	Chip reset voltage (CHIP_PU voltage is within the specified range)	-0.3	—	$0.25 \times VDD^1$	V

¹ VDD – voltage from a power pin of a respective power domain.

² V_{OH} and V_{OL} are measured using high-impedance load.

5.5 ADC Characteristics

The measurements in this section are taken with an external 100 nF capacitor connected to the ADC, using DC signals as input, and at an ambient temperature of 25 °C with disabled Wi-Fi.

Table 5-5. ADC Characteristics

Symbol	Min	Max	Unit
DNL (Differential nonlinearity) ¹	-4	4	LSB
INL (Integral nonlinearity)	-8	8	LSB
Sampling rate	—	100	kSPS ²

¹ To get better DNL results, you can sample multiple times and apply a filter, or calculate the average value.

² kSPS means kilo samples-per-second.

The calibrated ADC results after hardware calibration and [software calibration](#) are shown in Table 5-6. For higher accuracy, you may implement your own calibration methods.

Table 5-6. ADC Calibration Results

Parameter	Description	Min	Max	Unit
Total error	ATTEN0, effective measurement range of 0 ~ 850	-5	5	mV
	ATTEN1, effective measurement range of 0 ~ 1100	-6	6	mV
	ATTEN2, effective measurement range of 0 ~ 1600	-10	10	mV
	ATTEN3, effective measurement range of 0 ~ 2900	-50	50	mV

5.6 Current Consumption

5.6.1 RF Current Consumption in Active Mode

The current consumption measurements are taken with a 3.3 V supply at 25 °C of ambient temperature at the RF port. All transmitters' measurements are based on a 100% duty cycle.

Table 5-7. Wi-Fi Current Consumption Depending on RF Modes

Work Mode ¹	Description	Peak (mA)	
Active (RF working)	TX	802.11b, 1 Mbps, @21 dBm	340
		802.11g, 54 Mbps, @19 dBm	291
		802.11n, HT20, MCS7, @18.5 dBm	283
		802.11n, HT40, MCS7, @18 dBm	286
	RX	802.11b/g/n, HT20	88
		802.11n, HT40	91

¹ The CPU work mode: Single core runs 32-bit data access instructions at 80 MHz, the other core is in idle state.

5.6.2 Current Consumption in Other Modes

The measurements below are applicable to ESP32-S3 and ESP32-S3FH8. Since ESP32-S3R2, ESP32-S3R8, ESP32-S3R8V, ESP32-S3R16V, and ESP32-S3FN4R2 are embedded with PSRAM, their current consumption

might be higher.

Table 5-8. Current Consumption in Modem-sleep Mode

Work mode	Frequency (MHz)	Description	Typ ¹ (mA)	Typ ² (mA)
Modem-sleep ³	40	WAITI (Dual core in idle state)	13.2	18.8
		Single core running 32-bit data access instructions, the other core in idle state	16.2	21.8
		Dual core running 32-bit data access instructions	18.7	24.4
		Single core running 128-bit data access instructions, the other core in idle state	19.9	25.4
		Dual core running 128-bit data access instructions	23.0	28.8
	80	WAITI	22.0	36.1
		Single core running 32-bit data access instructions, the other core in idle state	28.4	42.6
		Dual core running 32-bit data access instructions	33.1	47.3
		Single core running 128-bit data access instructions, the other core in idle state	35.1	49.6
		Dual core running 128-bit data access instructions	41.8	56.3
	160	WAITI	27.6	42.3
		Single core running 32-bit data access instructions, the other core in idle state	39.9	54.6
		Dual core running 32-bit data access instructions	49.6	64.1
		Single core running 128-bit data access instructions, the other core in idle state	54.4	69.2
		Dual core running 128-bit data access instructions	66.7	81.1
	240	WAITI	32.9	47.6
		Single core running 32-bit data access instructions, the other core in idle state	51.2	65.9
		Dual core running 32-bit data access instructions	66.2	81.3
		Single core running 128-bit data access instructions, the other core in idle state	72.4	87.9
		Dual core running 128-bit data access instructions	91.7	107.9

¹ Current consumption when all peripheral clocks are **disabled**.

² Current consumption when all peripheral clocks are **enabled**. In practice, the current consumption might be different depending on which peripherals are enabled.

³ In Modem-sleep mode, Wi-Fi is clock gated, and the current consumption might be higher when accessing flash. For a flash rated at 80 Mbit/s, in SPI 2-line mode the consumption is 10 mA.

Table 5-9. Current Consumption in Low-Power Modes

Work mode	Description	Typ (μ A)
Light-sleep ¹	VDD_SPI and Wi-Fi are powered down, and all GPIOs are high-impedance.	240
Deep-sleep	RTC memory and RTC peripherals are powered up.	8

	RTC memory is powered up. RTC peripherals are powered down.	7
Power off	CHIP_PU is set to low level. The chip is shut down.	1

¹ In Light-sleep mode, all related SPI pins are pulled up. For chips embedded with PSRAM, please add corresponding PSRAM consumption values, e.g., 140 μA for 8 MB Octal PSRAM (3.3 V), 200 μA for 8 MB Octal PSRAM (1.8 V) and 40 μA for 2 MB Quad PSRAM (3.3 V).

5.7 Reliability

Table 5-10. Reliability Qualifications

Test Item	Test Conditions	Test Standard
HTOL (High Temperature Operating Life)	125 °C, 1000 hours	JESD22-A108
ESD (Electro-Static Discharge Sensitivity)	HBM (Human Body Mode) ¹ ± 2000 V	JS-001
	CDM (Charge Device Mode) ² ± 1000 V	JS-002
Latch up	Current trigger ± 200 mA	JESD78
	Voltage trigger $1.5 \times VDD_{max}$	
Preconditioning	Bake 24 hours @125 °C Moisture soak (level 3: 192 hours @30 °C, 60% RH) IR reflow solder: 260 + 0 °C, 20 seconds, three times	J-STD-020, JESD47, JESD22-A113
TCT (Temperature Cycling Test)	-65 °C / 150 °C, 500 cycles	JESD22-A104
uHAST (Highly Accelerated Stress Test, unbiased)	130 °C, 85% RH, 96 hours	JESD22-A118
HTSL (High Temperature Storage Life)	150 °C, 1000 hours	JESD22-A103
LTSL (Low Temperature Storage Life)	-40 °C, 1000 hours	JESD22-A119

¹ JEDEC document JEP155 states that 500 V HBM allows safe manufacturing with a standard ESD control process.

² JEDEC document JEP157 states that 250 V CDM allows safe manufacturing with a standard ESD control process.

6 RF Characteristics

This section contains tables with RF characteristics of the Espressif product.

The RF data is measured at the antenna port, where RF cable is connected, including the front-end loss. The front-end circuit is a 0 Ω resistor.

Devices should operate in the center frequency range allocated by regional regulatory authorities. The target center frequency range and the target transmit power are configurable by software. See [ESP RF Test Tool and Test Guide](#) for instructions.

Unless otherwise stated, the RF tests are conducted with a 3.3 V ($\pm 5\%$) supply at 25 °C ambient temperature.

6.1 Wi-Fi Radio

Table 6-1. Wi-Fi RF Characteristics

Name	Description
Center frequency range of operating channel	2412 ~ 2484 MHz
Wi-Fi wireless standard	IEEE 802.11b/g/n

6.1.1 Wi-Fi RF Transmitter (TX) Specifications

Table 6-2. TX Power with Spectral Mask and EVM Meeting 802.11 Standards

Rate	Min (dBm)	Typ (dBm)	Max (dBm)
802.11b, 1 Mbps	—	21.0	—
802.11b, 11 Mbps	—	21.0	—
802.11g, 6 Mbps	—	20.5	—
802.11g, 54 Mbps	—	19.0	—
802.11n, HT20, MCS0	—	19.5	—
802.11n, HT20, MCS7	—	18.5	—
802.11n, HT40, MCS0	—	19.5	—
802.11n, HT40, MCS7	—	18.0	—

Table 6-3. TX EVM Test¹

Rate	Min (dB)	Typ (dB)	Limit (dB)
802.11b, 1 Mbps, @21 dBm	—	-24.5	-10
802.11b, 11 Mbps, @21 dBm	—	-24.5	-10
802.11g, 6 Mbps, @20.5 dBm	—	-21.5	-5
802.11g, 54 Mbps, @19 dBm	—	-28.0	-25
802.11n, HT20, MCS0, @19.5 dBm	—	-23.0	-5
802.11n, HT20, MCS7, @18.5 dBm	—	-29.5	-27

Cont'd on next page

Table 6-3 – cont'd from previous page

Rate	Min (dB)	Typ (dB)	Limit (dB)
802.11n, HT40, MCS0, @19.5 dBm	—	-23.0	-5
802.11n, HT40, MCS7, @18 dBm	—	-29.5	-27

¹ EVM is measured at the corresponding typical TX power provided in Table 6-2 *TX Power with Spectral Mask and EVM Meeting 802.11 Standards* above.

6.1.2 Wi-Fi RF Receiver (RX) Specifications

For RX tests, the PER (packet error rate) limit is 8% for 802.11b, and 10% for 802.11g/n.

Table 6-4. RX Sensitivity

Rate	Min (dBm)	Typ (dBm)	Max (dBm)
802.11b, 1 Mbps	—	-98.4	—
802.11b, 2 Mbps	—	-95.4	—
802.11b, 5.5 Mbps	—	-93.0	—
802.11b, 11 Mbps	—	-88.6	—
802.11g, 6 Mbps	—	-93.2	—
802.11g, 9 Mbps	—	-91.8	—
802.11g, 12 Mbps	—	-91.2	—
802.11g, 18 Mbps	—	-88.6	—
802.11g, 24 Mbps	—	-86.0	—
802.11g, 36 Mbps	—	-82.4	—
802.11g, 48 Mbps	—	-78.2	—
802.11g, 54 Mbps	—	-76.5	—
802.11n, HT20, MCS0	—	-92.6	—
802.11n, HT20, MCS1	—	-91.0	—
802.11n, HT20, MCS2	—	-88.2	—
802.11n, HT20, MCS3	—	-85.0	—
802.11n, HT20, MCS4	—	-81.8	—
802.11n, HT20, MCS5	—	-77.4	—
802.11n, HT20, MCS6	—	-75.8	—
802.11n, HT20, MCS7	—	-74.2	—
802.11n, HT40, MCS0	—	-90.0	—
802.11n, HT40, MCS1	—	-88.0	—
802.11n, HT40, MCS2	—	-85.2	—
802.11n, HT40, MCS3	—	-82.0	—
802.11n, HT40, MCS4	—	-79.0	—
802.11n, HT40, MCS5	—	-74.4	—
802.11n, HT40, MCS6	—	-72.8	—
802.11n, HT40, MCS7	—	-71.4	—

Table 6-5. Maximum RX Level

Rate	Min (dBm)	Typ (dBm)	Max (dBm)
802.11b, 1 Mbps	—	5	—
802.11b, 11 Mbps	—	5	—
802.11g, 6 Mbps	—	5	—
802.11g, 54 Mbps	—	0	—
802.11n, HT20, MCS0	—	5	—
802.11n, HT20, MCS7	—	0	—
802.11n, HT40, MCS0	—	5	—
802.11n, HT40, MCS7	—	0	—

Table 6-6. RX Adjacent Channel Rejection

Rate	Min (dB)	Typ (dB)	Max (dB)
802.11b, 1 Mbps	—	35	—
802.11b, 11 Mbps	—	35	—
802.11g, 6 Mbps	—	31	—
802.11g, 54 Mbps	—	20	—
802.11n, HT20, MCS0	—	31	—
802.11n, HT20, MCS7	—	16	—
802.11n, HT40, MCS0	—	25	—
802.11n, HT40, MCS7	—	11	—

6.2 Bluetooth LE Radio

Table 6-7. Bluetooth LE Frequency

Parameter	Min (MHz)	Typ (MHz)	Max (MHz)
Center frequency of operating channel	2402	—	2480

6.2.1 Bluetooth LE RF Transmitter (TX) Specifications

Table 6-8. Transmitter Characteristics - Bluetooth LE 1 Mbps

Parameter	Description	Min	Typ	Max	Unit
RF transmit power	RF power control range	-24.00	0	20.00	dBm
	Gain control step	—	3.00	—	dB
Carrier frequency offset and drift	Max $ f_n _{n=0, 1, 2, \dots, k}$	—	2.50	—	kHz
	Max $ f_0 - f_n $	—	2.00	—	kHz
	Max $ f_n - f_{n-5} $	—	1.39	—	kHz

Cont'd on next page

Table 6-8 – cont'd from previous page

Parameter	Description	Min	Typ	Max	Unit
	$ f_1 - f_0 $	—	0.80	—	kHz
Modulation characteristics	$\Delta f_{1_{avg}}$	—	249.00	—	kHz
	Min $\Delta f_{2_{max}}$ (for at least 99.9% of all $\Delta f_{2_{max}}$)	—	198.00	—	kHz
	$\Delta f_{2_{avg}}/\Delta f_{1_{avg}}$	—	0.86	—	—
In-band spurious emissions	± 2 MHz offset	—	-37.00	—	dBm
	± 3 MHz offset	—	-42.00	—	dBm
	$>\pm 3$ MHz offset	—	-44.00	—	dBm

Table 6-9. Transmitter Characteristics - Bluetooth LE 2 Mbps

Parameter	Description	Min	Typ	Max	Unit
RF transmit power	RF power control range	-24.00	0	20.00	dBm
	Gain control step	—	3.00	—	dB
Carrier frequency offset and drift	Max $ f_n _{n=0, 1, 2, \dots, k}$	—	2.50	—	kHz
	Max $ f_0 - f_n $	—	1.90	—	kHz
	Max $ f_n - f_{n-5} $	—	1.40	—	kHz
	$ f_1 - f_0 $	—	1.10	—	kHz
Modulation characteristics	$\Delta f_{1_{avg}}$	—	499.00	—	kHz
	Min $\Delta f_{2_{max}}$ (for at least 99.9% of all $\Delta f_{2_{max}}$)	—	416.00	—	kHz
	$\Delta f_{2_{avg}}/\Delta f_{1_{avg}}$	—	0.89	—	—
In-band spurious emissions	± 4 MHz offset	—	-43.80	—	dBm
	± 5 MHz offset	—	-45.80	—	dBm
	$>\pm 5$ MHz offset	—	-47.00	—	dBm

Table 6-10. Transmitter Characteristics - Bluetooth LE 125 Kbps

Parameter	Description	Min	Typ	Max	Unit
RF transmit power	RF power control range	-24.00	0	20.00	dBm
	Gain control step	—	3.00	—	dB
Carrier frequency offset and drift	Max $ f_n _{n=0, 1, 2, \dots, k}$	—	0.80	—	kHz
	Max $ f_0 - f_n $	—	0.98	—	kHz
	$ f_n - f_{n-3} $	—	0.30	—	kHz
	$ f_0 - f_3 $	—	1.00	—	kHz
Modulation characteristics	$\Delta f_{1_{avg}}$	—	248.00	—	kHz
	Min $\Delta f_{1_{max}}$ (for at least 99.9% of all $\Delta f_{1_{max}}$)	—	222.00	—	kHz
In-band spurious emissions	± 2 MHz offset	—	-37.00	—	dBm
	± 3 MHz offset	—	-42.00	—	dBm
	$>\pm 3$ MHz offset	—	-44.00	—	dBm

Table 6-11. Transmitter Characteristics - Bluetooth LE 500 Kbps

Parameter	Description	Min	Typ	Max	Unit
RF transmit power	RF power control range	-24.00	0	20.00	dBm
	Gain control step	—	3.00	—	dB
Carrier frequency offset and drift	Max $ f_n _{n=0, 1, 2, \dots, k}$	—	0.70	—	kHz
	Max $ f_0 - f_n $	—	0.90	—	kHz
	$ f_n - f_{n-3} $	—	0.85	—	kHz
	$ f_0 - f_3 $	—	0.34	—	kHz
Modulation characteristics	$\Delta f_{2_{avg}}$	—	213.00	—	kHz
	Min $\Delta f_{2_{max}}$ (for at least 99.9% of all $\Delta f_{2_{max}}$)	—	196.00	—	kHz
In-band spurious emissions	± 2 MHz offset	—	-37.00	—	dBm
	± 3 MHz offset	—	-42.00	—	dBm
	$> \pm 3$ MHz offset	—	-44.00	—	dBm

6.2.2 Bluetooth LE RF Receiver (RX) Specifications

Table 6-12. Receiver Characteristics - Bluetooth LE 1 Mbps

Parameter	Description	Min	Typ	Max	Unit
Sensitivity @30.8% PER	—	—	-97.5	—	dBm
Maximum received signal @30.8% PER	—	—	8	—	dBm
Co-channel C/I	F = FO MHz	—	9	—	dB
Adjacent channel selectivity C/I	F = FO + 1 MHz	—	-3	—	dB
	F = FO - 1 MHz	—	-3	—	dB
	F = FO + 2 MHz	—	-28	—	dB
	F = FO - 2 MHz	—	-30	—	dB
	F = FO + 3 MHz	—	-31	—	dB
	F = FO - 3 MHz	—	-33	—	dB
	F > FO + 3 MHz	—	-32	—	dB
F > FO - 3 MHz	—	-36	—	dB	
Image frequency	—	—	-32	—	dB
Adjacent channel to image frequency	F = $F_{image} + 1$ MHz	—	-39	—	dB
	F = $F_{image} - 1$ MHz	—	-31	—	dB
Out-of-band blocking performance	30 MHz ~ 2000 MHz	—	-9	—	dBm
	2003 MHz ~ 2399 MHz	—	-19	—	dBm
	2484 MHz ~ 2997 MHz	—	-16	—	dBm
	3000 MHz ~ 12.75 GHz	—	-5	—	dBm
Intermodulation	—	—	-31	—	dBm

Table 6-13. Receiver Characteristics - Bluetooth LE 2 Mbps

Parameter	Description	Min	Typ	Max	Unit
Sensitivity @30.8% PER	—	—	-93.5	—	dBm
Maximum received signal @30.8% PER	—	—	3	—	dBm
Co-channel C/I	F = FO MHz	—	10	—	dB
Adjacent channel selectivity C/I	F = FO + 2 MHz	—	-8	—	dB
	F = FO - 2 MHz	—	-5	—	dB
	F = FO + 4 MHz	—	-31	—	dB
	F = FO - 4 MHz	—	-33	—	dB
	F = FO + 6 MHz	—	-37	—	dB
	F = FO - 6 MHz	—	-37	—	dB
	F > FO + 6 MHz	—	-40	—	dB
	F > FO - 6 MHz	—	-40	—	dB
Image frequency	—	—	-31	—	dB
Adjacent channel to image frequency	F = F _{image} + 2 MHz	—	-37	—	dB
	F = F _{image} - 2 MHz	—	-8	—	dB
Out-of-band blocking performance	30 MHz ~ 2000 MHz	—	-16	—	dBm
	2003 MHz ~ 2399 MHz	—	-20	—	dBm
	2484 MHz ~ 2997 MHz	—	-16	—	dBm
	3000 MHz ~ 12.75 GHz	—	-16	—	dBm
Intermodulation	—	—	-30	—	dBm

Table 6-14. Receiver Characteristics - Bluetooth LE 125 Kbps

Parameter	Description	Min	Typ	Max	Unit
Sensitivity @30.8% PER	—	—	-104.5	—	dBm
Maximum received signal @30.8% PER	—	—	8	—	dBm
Co-channel C/I	F = FO MHz	—	6	—	dB
Adjacent channel selectivity C/I	F = FO + 1 MHz	—	-6	—	dB
	F = FO - 1 MHz	—	-5	—	dB
	F = FO + 2 MHz	—	-32	—	dB
	F = FO - 2 MHz	—	-39	—	dB
	F = FO + 3 MHz	—	-35	—	dB
	F = FO - 3 MHz	—	-45	—	dB
	F > FO + 3 MHz	—	-35	—	dB
	F > FO - 3 MHz	—	-48	—	dB
Image frequency	—	—	-35	—	dB
Adjacent channel to image frequency	F = F _{image} + 1 MHz	—	-49	—	dB
	F = F _{image} - 1 MHz	—	-32	—	dB

Table 6-15. Receiver Characteristics - Bluetooth LE 500 Kbps

Parameter	Description	Min	Typ	Max	Unit
Sensitivity @30.8% PER	—	—	-101	—	dBm
Maximum received signal @30.8% PER	—	—	8	—	dBm
Co-channel C/I	$F = F_0$ MHz	—	4	—	dB
Adjacent channel selectivity C/I	$F = F_0 + 1$ MHz	—	-5	—	dB
	$F = F_0 - 1$ MHz	—	-5	—	dB
	$F = F_0 + 2$ MHz	—	-28	—	dB
	$F = F_0 - 2$ MHz	—	-36	—	dB
	$F = F_0 + 3$ MHz	—	-36	—	dB
	$F = F_0 - 3$ MHz	—	-38	—	dB
	$F > F_0 + 3$ MHz	—	-37	—	dB
Adjacent channel to image frequency	$F > F_0 - 3$ MHz	—	-41	—	dB
	Image frequency	—	-37	—	dB
Adjacent channel to image frequency	$F = F_{image} + 1$ MHz	—	-44	—	dB
	$F = F_{image} - 1$ MHz	—	-28	—	dB

7 Packaging

- For information about tape, reel, and product marking, please refer to [ESP32-S3 Chip Packaging Information](#).
- The pins of the chip are numbered in anti-clockwise order starting from Pin 1 in the top view. For pin numbers and pin names, see also Figure 2-1 *ESP32-S3 Pin Layout (Top View)*.
- The recommended land pattern [source file \(asc\)](#) is available for download. You can import the file with software such as PADS and Altium Designer.
- All ESP32-S3 chip variants have identical land pattern (see Figure 7-1) except ESP32-S3FH4R2 has a bigger EPAD (see Figure 7-2). The [source file \(asc\)](#) may be adopted for ESP32-S3FH4R2 by altering the size of the EPAD (see dimensions D2 and E2 in Figure 7-2).

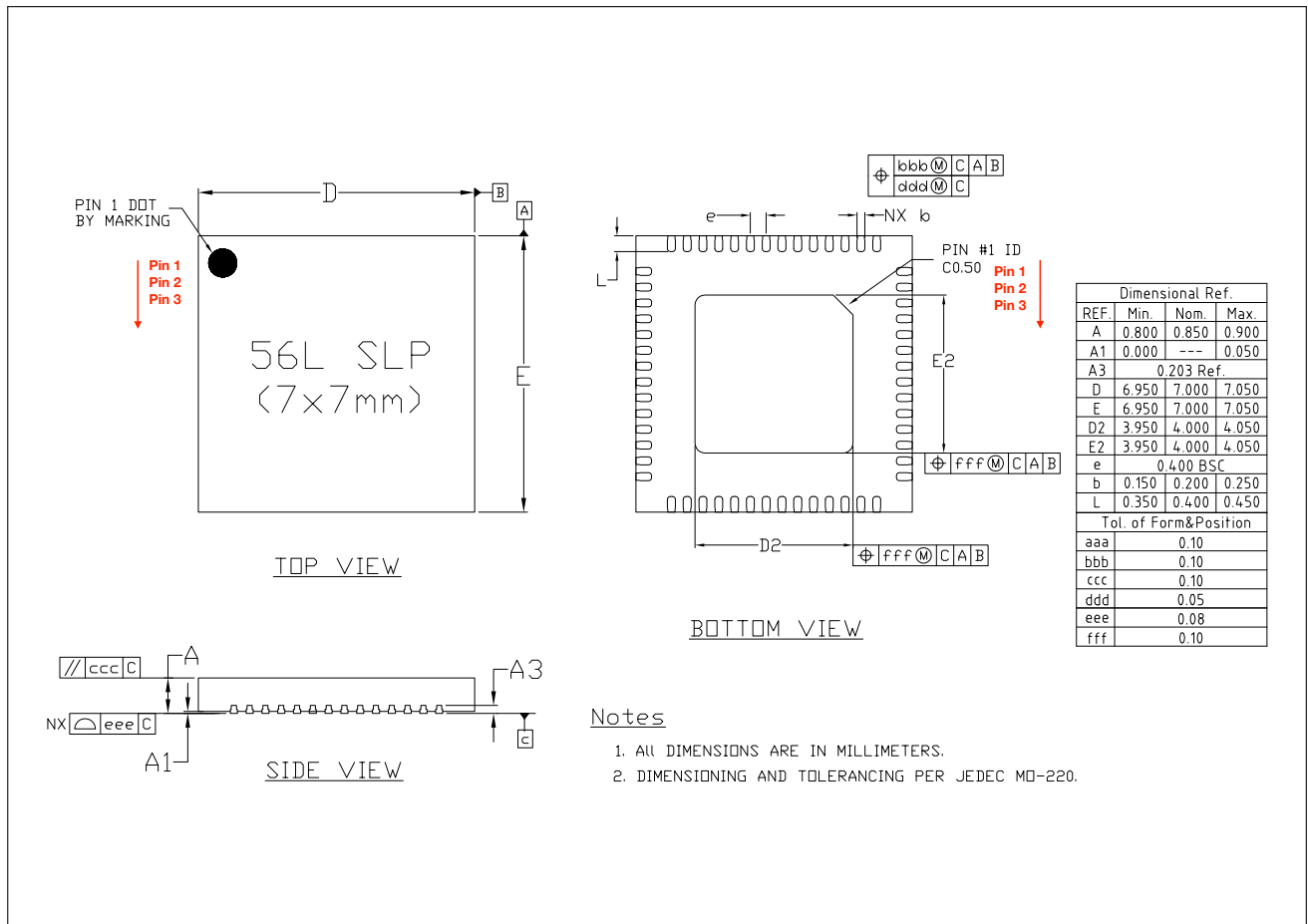

Figure 7-1. QFN56 (7x7 mm) Package

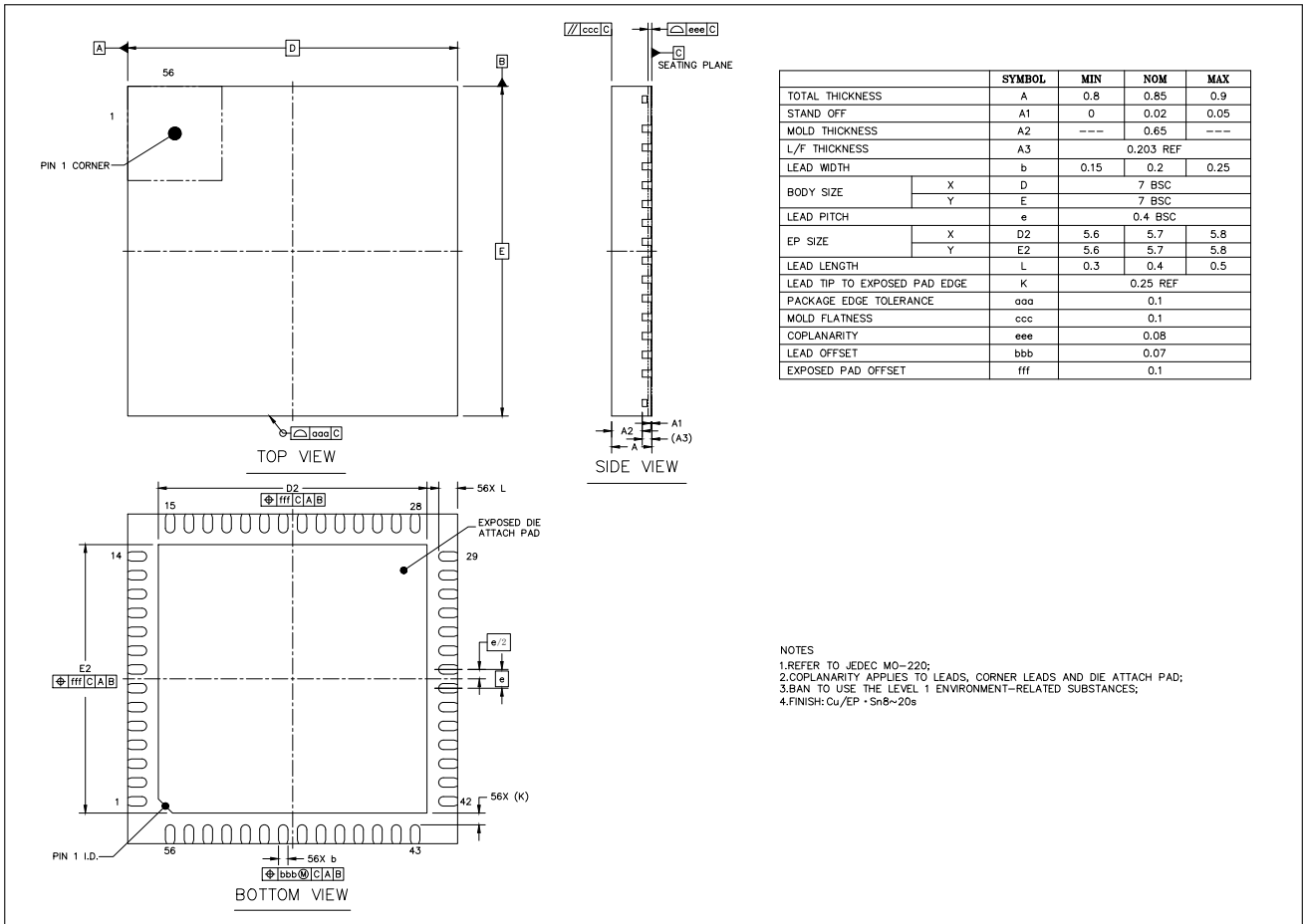

Figure 7-2. QFN56 (7x7 mm) Package (Only for ESP32-S3FH4R2)

Appendix A – ESP32-S3 Consolidated Pin Overview

Pin No.	Pin Name	Pin Type	Pin Providing Power	Pin Settings		RTC Function		Analog Function			IO MUX Function													
				At Reset	After Reset	0	3	0	1	0	Type	1	Type	2	Type	3	Type	4	Type					
1	LNA_IN	Analog																						
2	VDD3P3	Power																						
3	VDD3P3	Power																						
4	CHIP_PU	Analog	VDD3P3_RTC																					
5	GPIO0	IO	VDD3P3_RTC	IE, WPU	IE, WPU	RTC_GPIO0	sar_i2c_scl_0			GPIO0	I/O/T	GPIO0	I/O/T											
6	GPIO1	IO	VDD3P3_RTC	IE	IE	RTC_GPIO1	sar_i2c_sda_0	TOUCH1	ADC1_CH0	GPIO1	I/O/T	GPIO1	I/O/T											
7	GPIO2	IO	VDD3P3_RTC	IE	IE	RTC_GPIO2	sar_i2c_scl_1	TOUCH2	ADC1_CH1	GPIO2	I/O/T	GPIO2	I/O/T											
8	GPIO3	IO	VDD3P3_RTC	IE	IE	RTC_GPIO3	sar_i2c_sda_1	TOUCH3	ADC1_CH2	GPIO3	I/O/T	GPIO3	I/O/T											
9	GPIO4	IO	VDD3P3_RTC			RTC_GPIO4		TOUCH4	ADC1_CH3	GPIO4	I/O/T	GPIO4	I/O/T											
10	GPIO5	IO	VDD3P3_RTC			RTC_GPIO5		TOUCH5	ADC1_CH4	GPIO5	I/O/T	GPIO5	I/O/T											
11	GPIO6	IO	VDD3P3_RTC			RTC_GPIO6		TOUCH6	ADC1_CH5	GPIO6	I/O/T	GPIO6	I/O/T											
12	GPIO7	IO	VDD3P3_RTC			RTC_GPIO7		TOUCH7	ADC1_CH6	GPIO7	I/O/T	GPIO7	I/O/T											
13	GPIO8	IO	VDD3P3_RTC			RTC_GPIO8		TOUCH8	ADC1_CH7	GPIO8	I/O/T	GPIO8	I/O/T											
14	GPIO9	IO	VDD3P3_RTC		IE	RTC_GPIO9		TOUCH9	ADC1_CH8	GPIO9	I/O/T	GPIO9	I/O/T								SUBSPICS1	O/T		
15	GPIO10	IO	VDD3P3_RTC		IE	RTC_GPIO10		TOUCH10	ADC1_CH9	GPIO10	I/O/T	GPIO10	I/O/T	FSPII04	II/O/T	SUBSPICS0	O/T	FSPICS0	II/O/T					
16	GPIO11	IO	VDD3P3_RTC		IE	RTC_GPIO11		TOUCH11	ADC2_CH0	GPIO11	I/O/T	GPIO11	I/O/T	FSPII05	II/O/T	SUBSPID	II/O/T	FSPIID	II/O/T					
17	GPIO12	IO	VDD3P3_RTC		IE	RTC_GPIO12		TOUCH12	ADC2_CH1	GPIO12	I/O/T	GPIO12	I/O/T	FSPII06	II/O/T	SUBSPICLK	O/T	FSPICLK	II/O/T					
18	GPIO13	IO	VDD3P3_RTC		IE	RTC_GPIO13		TOUCH13	ADC2_CH2	GPIO13	I/O/T	GPIO13	I/O/T	FSPII07	II/O/T	SUBSPIQ	II/O/T	FSPIQ	II/O/T					
19	GPIO14	IO	VDD3P3_RTC		IE	RTC_GPIO14		TOUCH14	ADC2_CH3	GPIO14	I/O/T	GPIO14	I/O/T	FSPIDQS	O/T	SUBSPIWP	II/O/T	FSPIWP	II/O/T					
20	VDD3P3_RTC	Power																						
21	XTAL_32K_P	IO	VDD3P3_RTC			RTC_GPIO15		XTAL_32K_P	ADC2_CH4	GPIO15	I/O/T	GPIO15	I/O/T	UORTS	O									
22	XTAL_32K_N	IO	VDD3P3_RTC			RTC_GPIO16		XTAL_32K_N	ADC2_CH5	GPIO16	I/O/T	GPIO16	I/O/T	UOCTS	II									
23	GPIO17	IO	VDD3P3_RTC		IE	RTC_GPIO17			ADC2_CH6	GPIO17	I/O/T	GPIO17	I/O/T	UITXD	O									
24	GPIO18	IO	VDD3P3_RTC		IE	RTC_GPIO18			ADC2_CH7	GPIO18	I/O/T	GPIO18	I/O/T	UIRXD	II	CLK_OUT3	O							
25	GPIO19	IO	VDD3P3_RTC			RTC_GPIO19		USB_D-	ADC2_CH8	GPIO19	I/O/T	GPIO19	I/O/T	UIRTS	O	CLK_OUT2	O							
26	GPIO20	IO	VDD3P3_RTC	USB_PU	USB_PU	RTC_GPIO20		USB_D+	ADC2_CH9	GPIO20	I/O/T	GPIO20	I/O/T	UICTS	II	CLK_OUT1	O							
27	GPIO21	IO	VDD3P3_RTC			RTC_GPIO21				GPIO21	I/O/T	GPIO21	I/O/T											
28	SPICS1	IO	VDD_SPI	IE, WPU	IE, WPU					SPICS1	O/T	GPIO26	I/O/T											
29	VDD_SPI	Power																						
30	SPIHD	IO	VDD_SPI	IE, WPU	IE, WPU					SPIHD	II/O/T	GPIO27	I/O/T											
31	SPIWP	IO	VDD_SPI	IE, WPU	IE, WPU					SPIWP	II/O/T	GPIO28	I/O/T											
32	SPICS0	IO	VDD_SPI	IE, WPU	IE, WPU					SPICS0	O/T	GPIO29	I/O/T											
33	SPICLK	IO	VDD_SPI	IE, WPU	IE, WPU					SPICLK	O/T	GPIO30	I/O/T											
34	SPIQ	IO	VDD_SPI	IE, WPU	IE, WPU					SPIQ	II/O/T	GPIO31	I/O/T											
35	SPIID	IO	VDD_SPI	IE, WPU	IE, WPU					SPIID	II/O/T	GPIO32	I/O/T											
36	SPICLK_N	IO	VDD_SPI / VDD3P3_CPU	IE	IE					SPI CLK_N_DIFF	O/T	GPIO48	I/O/T	SUBSPI CLK_N_DIFF	O/T									
37	SPICLK_P	IO	VDD_SPI / VDD3P3_CPU	IE	IE					SPI CLK_P_DIFF	O/T	GPIO47	I/O/T	SUBSPI CLK_P_DIFF	O/T									
38	GPIO33	IO	VDD_SPI / VDD3P3_CPU		IE					GPIO33	I/O/T	GPIO33	I/O/T	FSPID	II/O/T	SUBSPIHD	II/O/T	SPII04	II/O/T					
39	GPIO34	IO	VDD_SPI / VDD3P3_CPU		IE					GPIO34	I/O/T	GPIO34	I/O/T	FSPICS0	II/O/T	SUBSPICS0	O/T	SPII05	II/O/T					
40	GPIO35	IO	VDD_SPI / VDD3P3_CPU		IE					GPIO35	I/O/T	GPIO35	I/O/T	FSPID	II/O/T	SUBSPID	II/O/T	SPII06	II/O/T					
41	GPIO36	IO	VDD_SPI / VDD3P3_CPU		IE					GPIO36	I/O/T	GPIO36	I/O/T	FSPICLK	II/O/T	SUBSPICLK	O/T	SPII07	II/O/T					
42	GPIO37	IO	VDD_SPI / VDD3P3_CPU		IE					GPIO37	I/O/T	GPIO37	I/O/T	FSPIQ	II/O/T	SUBSPIQ	II/O/T	SPIIDQS	IO/O/T					
43	GPIO38	IO	VDD3P3_CPU		IE					GPIO38	I/O/T	GPIO38	I/O/T	FSPIWP	II/O/T	SUBSPIWP	II/O/T							
44	MTCK	IO	VDD3P3_CPU		IE*					MTCK	II	GPIO39	I/O/T	CLK_OUT3	O	SUBSPICS1	O/T							
45	MTDO	IO	VDD3P3_CPU		IE					MTDO	O/T	GPIO40	I/O/T	CLK_OUT2	O									
46	VDD3P3_CPU	Power																						
47	MTDI	IO	VDD3P3_CPU		IE					MTDI	II	GPIO41	I/O/T	CLK_OUT1	O									
48	MTMS	IO	VDD3P3_CPU		IE					MTMS	II	GPIO42	I/O/T											
49	UOTXD	IO	VDD3P3_CPU		IE, WPU	IE, WPU				UOTXD	O	GPIO43	I/O/T	CLK_OUT1	O									
50	UORXD	IO	VDD3P3_CPU		IE, WPU	IE, WPU				UORXD	II	GPIO44	I/O/T	CLK_OUT2	O									
51	GPIO45	IO	VDD3P3_CPU	IE, WPD	IE, WPD					GPIO45	I/O/T	GPIO45	I/O/T											
52	GPIO46	IO	VDD3P3_CPU	IE, WPD	IE, WPD					GPIO46	I/O/T	GPIO46	I/O/T											
53	XTAL_N	Analog																						
54	XTAL_P	Analog																						
55	VDDA	Power																						
56	VDDA	Power																						
57	GND	Power																						

* For details, see Section 2 Pins. Regarding highlighted cells, see Section 2.3.4 Restrictions for GPIOs and RTC_GPIOs.

Related Documentation and Resources

Related Documentation

- [ESP32-S3 Technical Reference Manual](#) – Detailed information on how to use the ESP32-S3 memory and peripherals.
- [ESP32-S3 Hardware Design Guidelines](#) – Guidelines on how to integrate the ESP32-S3 into your hardware product.
- [ESP32-S3 Series SoC Errata](#) – Descriptions of known errors in ESP32-S3 series of SoCs.
- *Certificates*
<https://espressif.com/en/support/documents/certificates>
- *ESP32-S3 Product/Process Change Notifications (PCN)*
<https://espressif.com/en/support/documents/pcns?keys=ESP32-S3>
- *ESP32-S3 Advisories* – Information on security, bugs, compatibility, component reliability.
<https://espressif.com/en/support/documents/advisories?keys=ESP32-S3>
- *Documentation Updates and Update Notification Subscription*
<https://espressif.com/en/support/download/documents>

Developer Zone

- [ESP-IDF Programming Guide for ESP32-S3](#) – Extensive documentation for the ESP-IDF development framework.
- *ESP-IDF* and other development frameworks on GitHub.
<https://github.com/espressif>
- *ESP32 BBS Forum* – Engineer-to-Engineer (E2E) Community for Espressif products where you can post questions, share knowledge, explore ideas, and help solve problems with fellow engineers.
<https://esp32.com/>
- *The ESP Journal* – Best Practices, Articles, and Notes from Espressif folks.
<https://blog.espressif.com/>
- See the tabs *SDKs and Demos, Apps, Tools, AT Firmware*.
<https://espressif.com/en/support/download/sdks-demos>

Products

- *ESP32-S3 Series SoCs* – Browse through all ESP32-S3 SoCs.
<https://espressif.com/en/products/socs?id=ESP32-S3>
- *ESP32-S3 Series Modules* – Browse through all ESP32-S3-based modules.
<https://espressif.com/en/products/modules?id=ESP32-S3>
- *ESP32-S3 Series DevKits* – Browse through all ESP32-S3-based devkits.
<https://espressif.com/en/products/devkits?id=ESP32-S3>
- *ESP Product Selector* – Find an Espressif hardware product suitable for your needs by comparing or applying filters.
<https://products.espressif.com/#/product-selector?language=en>

Contact Us

- See the tabs *Sales Questions, Technical Enquiries, Circuit Schematic & PCB Design Review, Get Samples* (Online stores), *Become Our Supplier, Comments & Suggestions*.
<https://espressif.com/en/contact-us/sales-questions>

Revision History

Date	Version	Release notes
2025-04-24	v2.0	<ul style="list-style-type: none"> • Updated the status of ESP32-S3R8V to End of Life • Updated the CoreMark® score in Section CPU and Memory • Updated Figure 4.1.2 Memory Organization in Section 4-1 Address Mapping Structure • Updated the temperature sensor's measurement range in Section 4.2.2.2 Temperature Sensor • Added some notes in Chapter 6 RF Characteristics • Updated the source file link for the recommended land pattern in Chapter 7 Packaging
2024-09-11	v1.9	<ul style="list-style-type: none"> • Updated descriptions on the title page • Updated feature descriptions in Section Features and adjusted the format • Updated the pin introduction in Section 2.2 Pin Overview and adjusted the format • Updated descriptions in Section 2.3 IO Pins, and divided Section RTC and Analog Pin Functions into Section 2.3.3 Analog Functions and Section 2.3.2 RTC Functions • Updated Section Strapping Pins to Section 3 Boot Configurations • Adjusted the structure and section order in Section 4 Functional Description, deleted Section Peripheral Pin Configurations, and added the Pin Assignment part in each subsection in Section 4.2 Peripherals
2023-11-24	v1.8	<ul style="list-style-type: none"> • Added chip variant ESP32-S3R16V and updated related information • Added the second and third table notes in Table 1-1 ESP32-S3 Series Comparison • Updated Section 3.1 Chip Boot Mode Control • Updated Section 5.5 ADC Characteristics • Other minor updates

Cont'd on next page

Cont'd from previous page

Date	Version	Release notes
2023-06	v1.7	<ul style="list-style-type: none"> ● Removed the sample status for ESP32-S3FH4R2 ● Updated Figure ESP32-S3 Functional Block Diagram and Figure 4-2 Components and Power Domains ● Added the predefined settings at reset and after reset for GPIO20 in Table 2-1 Pin Overview ● Updated notes for Table 2-4 IO MUX Pin Functions ● Updated the clock name “FOSC_CLK” to “RC_FAST_CLK” in Section 4.1.3.5 Power Management Unit (PMU) ● Updated descriptions in Section 4.2.1.5 Serial Peripheral Interface (SPI) and Section 4.1.4.3 RSA Accelerator ● Other minor updates
2023-02	v1.6	<ul style="list-style-type: none"> ● Improved the content in the following sections: <ul style="list-style-type: none"> – Section Product Overview – Section 2 Pins – Section 4.1.3.5 Power Management Unit (PMU) – Section 4.2.1.5 Serial Peripheral Interface (SPI) – Section 5.1 Absolute Maximum Ratings – Section 5.2 Recommended Power Supply Characteristics – Section 5.3 VDD_SPI Output Characteristics – Section 5.5 ADC Characteristics ● Added Appendix A ● Updated the notes in Section 1 ESP32-S3 Series Comparison and Section 7 Packaging ● Updated the effective measurement range in Table 5-5 ADC Characteristics ● Updated the Bluetooth maximum transmit power ● Other minor updates
2022-12	v1.5	<ul style="list-style-type: none"> ● Removed the “External PA is supported” feature from Section Features ● Updated the ambient temperature for ESP32-S3FH4R2 from –40 ~ 105 °C to –40 ~ 85 °C ● Added two notes in Section 7
2022-11	v1.4	<ul style="list-style-type: none"> ● Added the package information for ESP32-S3FH4R2 in Section 7 ● Added ESP32-S3 Series SoC Errata in Section 7 ● Other minor updates

Cont'd on next page

Cont'd from previous page

Date	Version	Release notes
2022-09	v1.3	<ul style="list-style-type: none"> ● Added a note about the maximum ambient temperature of R8 series chips to Table 1-1 and Table 5-2 ● Added information about power-up glitches for some pins in Section 2.2 ● Added the information about VDD3P3 power pins to Table 2.2 and Section 2.5.2 ● Updated section 4.3.3.1 ● Added the fourth note in Table 2-1 ● Updated the minimum and maximum values of Bluetooth LE RF transmit power in Section 6.2.1 ● Other minor updates
2022-07	v1.2	<ul style="list-style-type: none"> ● Updated description of ROM code printing in Section 3 ● Updated Figure <i>ESP32-S3 Functional Block Diagram</i> ● Update Section 5.6 ● Deleted the hyperlinks in <i>Application</i>
2022-04	v1.1	<ul style="list-style-type: none"> ● Synchronized eFuse size throughout ● Updated pin description in Table 2-1 ● Updated SPI resistance in Table 5-3 ● Added information about chip ESP32-S3FH4R2
2022-01	v1.0	<ul style="list-style-type: none"> ● Added wake-up sources for Deep-sleep mode ● Added Table 3-4 for default configurations of VDD_SPI ● Added ADC calibration results in Table 5-5 ● Added typical values when all peripherals and peripheral clocks are enabled to Table 5-8 ● Added more descriptions of modules/peripherals in Section 4 ● Updated Figure <i>ESP32-S3 Functional Block Diagram</i> ● Updated JEDEC specification ● Updated Wi-Fi RF data in Section 5.6 ● Updated temperature for ESP32-S3R8 and ESP32-S3R8V ● Updated description of Deep-sleep mode in Table 5-9 ● Updated wording throughout
2021-10-12	v0.6.1	Updated text description

Cont'd on next page

Cont'd from previous page

Date	Version	Release notes
2021-09-30	v0.6	<ul style="list-style-type: none"> • Updated to chip revision 1 by swapping pin 53 and pin 54 (XTAL_P and XTAL_N) • Updated Figure ESP32-S3 Functional Block Diagram • Added CoreMark score in section Features • Updated Section 3 • Added data for cumulative IO output current in Table 5-1 • Added data for Modem-sleep current consumption in Table 5-8 • Updated data in section 5.6, 6.1, and 6.2 • Updated wording throughout
2021-07-19	v0.5.1	<ul style="list-style-type: none"> • Added “for chip revision 0” on cover, in footer and watermark to indicate that the current and previous versions of this datasheet are for chip version 0 • Corrected a few typos
2021-07-09	v0.5	Preliminary version



Disclaimer and Copyright Notice

Information in this document, including URL references, is subject to change without notice.

ALL THIRD PARTY'S INFORMATION IN THIS DOCUMENT IS PROVIDED AS IS WITH NO WARRANTIES TO ITS AUTHENTICITY AND ACCURACY.

NO WARRANTY IS PROVIDED TO THIS DOCUMENT FOR ITS MERCHANTABILITY, NON-INFRINGEMENT, FITNESS FOR ANY PARTICULAR PURPOSE, NOR DOES ANY WARRANTY OTHERWISE ARISING OUT OF ANY PROPOSAL, SPECIFICATION OR SAMPLE.

All liability, including liability for infringement of any proprietary rights, relating to use of information in this document is disclaimed. No licenses express or implied, by estoppel or otherwise, to any intellectual property rights are granted herein.

The Wi-Fi Alliance Member logo is a trademark of the Wi-Fi Alliance. The Bluetooth logo is a registered trademark of Bluetooth SIG.

All trade names, trademarks and registered trademarks mentioned in this document are property of their respective owners, and are hereby acknowledged.

Copyright © 2025 Espressif Systems (Shanghai) Co., Ltd. All rights reserved.

www.espressif.com

Mouser Electronics

Authorized Distributor

Click to View Pricing, Inventory, Delivery & Lifecycle Information:

[Espressif:](#)

[ESP32-S3-BOX](#) [ESP32-S3R2](#) [ESP32-S3R8](#) [ESP32-S3R8V](#) [ESP32-S3-EYE](#) [ESP32-S3-Korvo-1](#) [ESP32-S3](#)
[ESP32-S3FN8](#) [ESP32-S3-BOX-Lite](#) [ESP32-S3FH4R2](#) [ESP32-S3-USB-OTG](#)