

Type FCA Acrylic Surface Mount Film Capacitors

Acrylic Stacked Metallized Film Capacitors for Filtering and Noise Attenuation

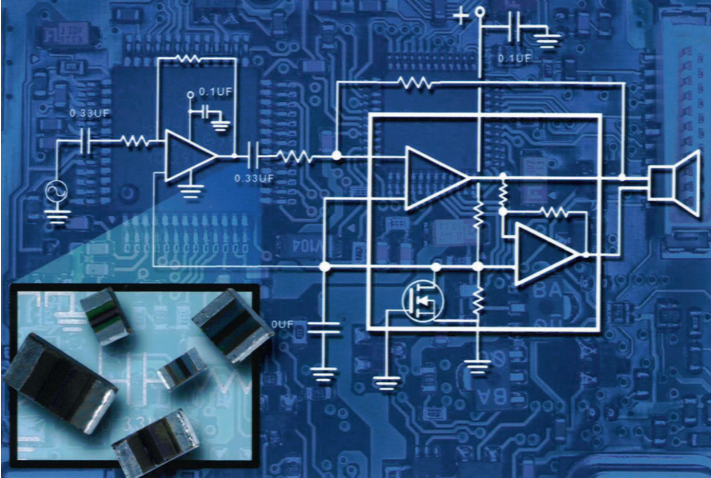

Type FCA acrylic film chips are non-inductive stacked metallized film capacitors which feature large capacitance values in standard surface mount case sizes.

Highlights

- Smallest film chips
- No piezoelectric effect
- Non-polarized, non-magnetic
- Low ESR
- 1.0 $\mu\text{F}/10\text{V}$ in 1206 case

Filtering • Decoupling • Noise Attenuation • Distortion Free Audio

Type FCA acrylic film capacitors offer high capacitance values in standard surface mount case sizes. They excel in attenuating DC power bus noise, and as ripple filters in dc to dc power conversion circuits. As coupling capacitors in audio circuits, they yield distortion free sound and better high frequency filtering. The 1.0 μF 10 Vdc rating offers a film capacitor that is a direct replacement for tantalum "A" case capacitors. The nonpolar FCA capacitor has lower ESR and lower DCL than an equivalent tantalum capacitor,

and in high frequency applications it takes a tantalum capacitor with ten times the capacitance to perform as well as the FCA capacitor.

The capacitor is constructed of noninductive stacked layers of metallized acrylic resin film with lead free solder (Sn/Ag/Cu) plated copper alloy terminals.

Specifications

Capacitance Range	0.10 μF to 1.0 μF
Capacitance Tolerance	$\pm 20\%$ @ 1 kHz and +20 °C
Rated Voltage	16 Vdc [1.0 μF in 1206 case, 10 Vdc]
Operating Temperature Range	-40 °C to +85 °C
AC Voltage Rating	12 Vrms
Dissipation Factor	0.015 @ 1 kHz and +20 °C
Dielectric Strength	175% of rated voltage for 5 seconds
Moisture Resistance	After 500 hours with rated voltage applied at +40 °C and 90 to 95% RH, the capacitor will meet the following limits: $\Delta C = +20/-3\%$ of the initial measured value $DF \leq 2.25\%$ (at 1 kHz) $IR > 100\text{M}\Omega$ ($C \leq 0.33 \mu\text{F}$) $IR > 30\text{M}\Omega \cdot \mu\text{F}$ ($C > 0.33 \mu\text{F}$) Dielectric Strength: Capacitor will withstand 130% of the rated voltage for 1 minute.
Life Test	Apply 125% of the rated DC working voltage at 85 °C for 1000 hours, and then stabilize them to +20 °C. Capacitors will meet the following limits: $C = +7\%/-20\%$ of the initial measured value $DF \leq 1.65\%$ (at 1 kHz) $IR > 300\text{M}\Omega$ ($C \leq 0.33 \mu\text{F}$) $IR > 100\text{M}\Omega \cdot \mu\text{F}$ ($C > 0.33 \mu\text{F}$)
Insulation Resistance (IR)	After 1 minute @10 Vdc; +20 °C $IR > 1000 \text{M}\Omega$ ($C \leq 0.33 \mu\text{F}$) $IR > 300 \text{M}\Omega \cdot \mu\text{F}$ ($C > 0.33 \mu\text{F}$)
Resistance to Soldering	The capacitor can withstand being heated in an oven at 235 °C for 200 sec.

RoHS Compliant

Type FCA Acrylic Surface Mount Film Capacitors

Ratings

For packaging codes/dimensions please click [here](#) for Application Guide

Capacitance (μ F)	Catalog Part Number	dv/dt (V/ μ s)	Maximum Current						
			10kHz (Arms)	20kHz (Arms)	50kHz (Arms)	100kHz (Arms)	200kHz (Arms)	500kHz (Arms)	1MHz (Arms)
10 Vdc									
1.00	FCA1206A105M-H3	3	0.60	0.76	1.05	1.220	1.35	1.43	1.43
16 Vdc									
.10	FCA0805C104M-J2	19	0.15	0.21	0.3	0.375	0.46	0.58	0.65
.15	FCA1206C154M-H1	15	0.21	0.28	0.37	0.450	0.54	0.62	0.68
.22	FCA1206C224M-H1	13	0.25	0.33	0.45	0.550	0.66	0.76	0.84
.33	FCA1206C334M-H2	10	0.35	0.45	0.61	0.740	0.84	0.94	1.00
.47	FCA1206C474M-H3	7	0.39	0.52	0.71	0.860	1.00	1.10	1.17
.68	FCA1206C684M-H3	5	0.48	0.625	0.85	1.040	1.19	1.31	1.34
1.00	FCA1210C105M-G2	3	0.60	0.78	1.05	1.250	1.38	1.46	1.46

Outline Drawing

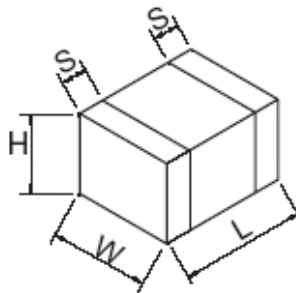

Outline Dimensions

Part Number Suffix	Case Code	Inches				Millimeters			
		L (± 0.008 in.)	W (± 0.008 in.)	H (± 0.008 in.)	S (± 0.012 in.)	L (± 0.2 mm)	W (± 0.2 mm)	H (± 0.2 mm)	S (± 0.3 mm)
J2	0805	0.079	0.049	0.039	0.018	2.0	1.25	1.0	0.45
H1	1206	0.126	0.063	0.032	0.026	3.2	1.60	0.8	0.65
H2	1206	0.126	0.063	0.039	0.026	3.2	1.60	1.0	0.65
H3	1206	0.126	0.063	0.055	0.026	3.2	1.60	1.4	0.65
G2	1210	0.126	0.098	0.055	0.026	3.2	2.50	1.4	0.65

Type FCA Acrylic Surface Mount Film Capacitors

Temperature Characteristics

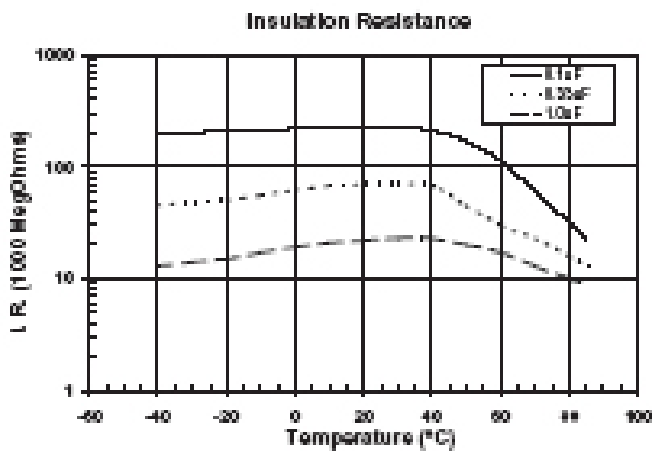
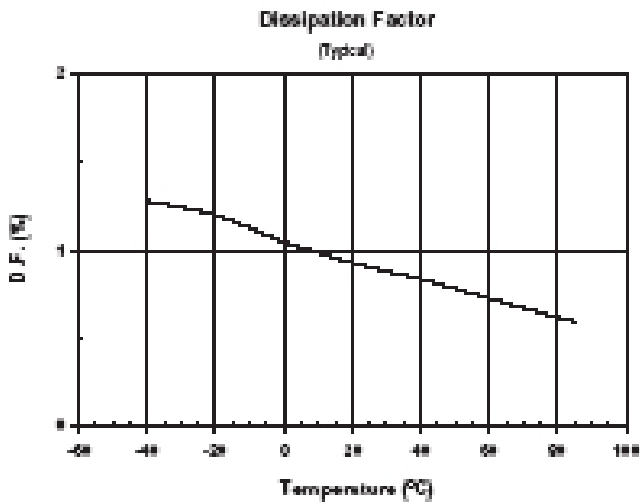
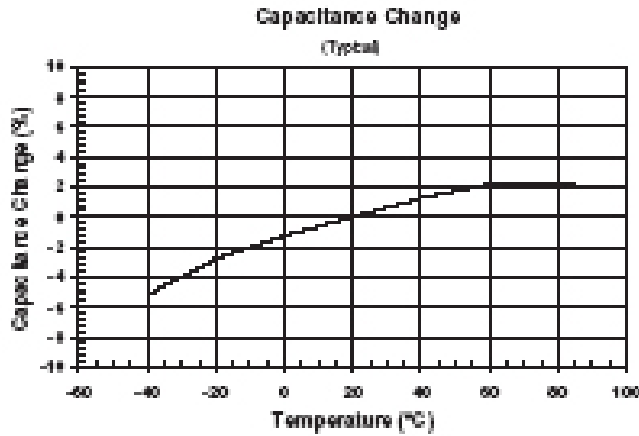

Frequency Characteristics

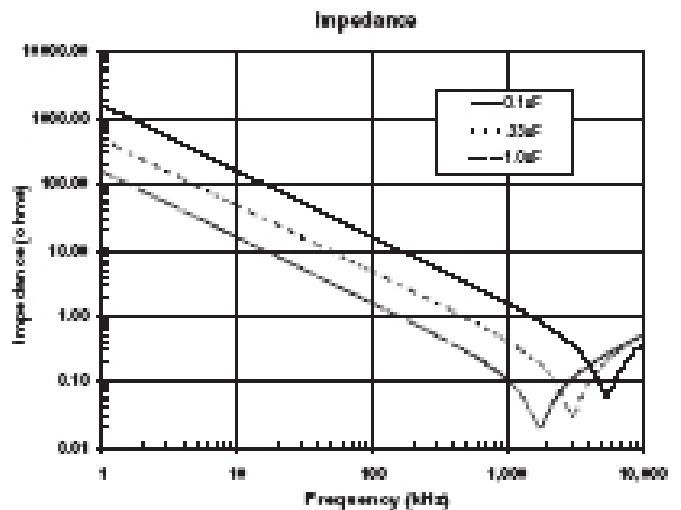
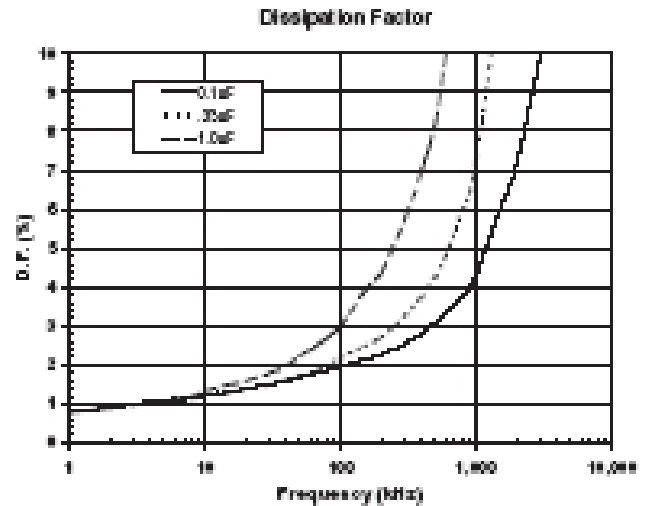
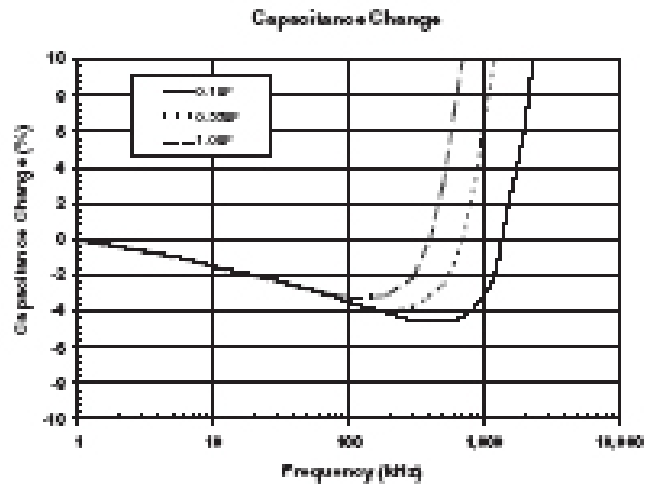

Type FCA Acrylic Surface Mount Film Capacitors

Typical Applications

Coupling Capacitor for Audio:

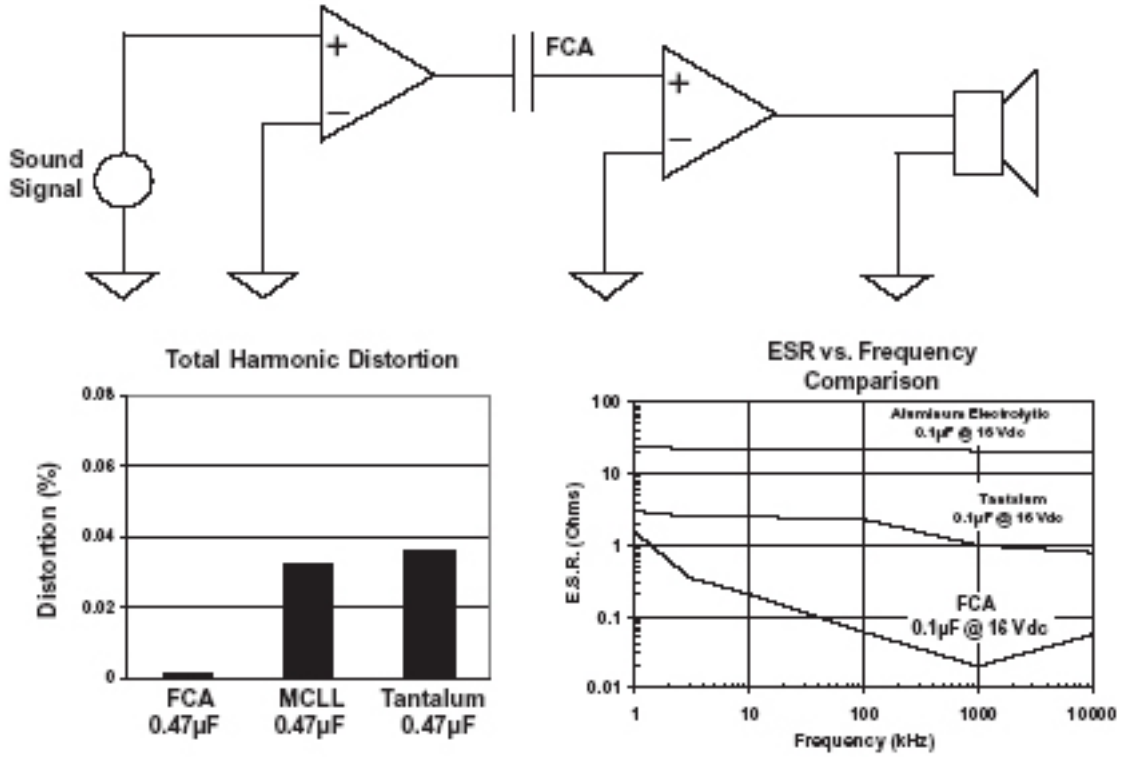

Using FCA capacitors in audio circuits can result in lower sound distortion. The low e.s.r., the absence of piezoelectric effects, and the non polar nature of the capacitor will eliminate sources of distortion in your audio circuits.

PLL Circuit: Cellular phone, Blue Tooth, Data Communication Card

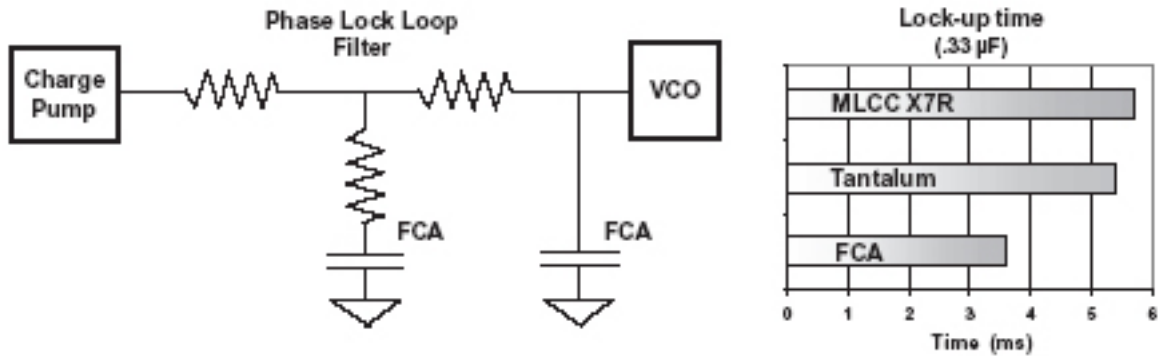

FCA surface mount film capacitors have advantages over tantalum and ceramic capacitors in PLL circuits. There are no piezoelectric effects to create noise, they are not polarized, and they result in faster signal lock-up time.

Type FCA Acrylic Surface Mount Film Capacitors

Typical Applications

Filtering Performance:

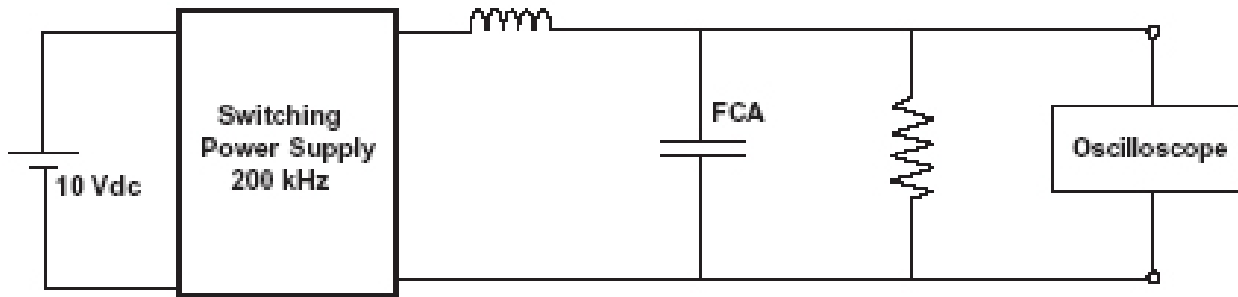

In the above circuit, one 1 μF FCA capacitor results in the same ripple reduction performance as a 10 μF tantalum capacitor at 200 kHz. With a 1 μF tantalum capacitor in the circuit the measured ripple voltage was 70 mVpp, and with a 10 μF tantalum or a 1 μF FCA capacitor the ripple voltage was 8 mVpp.

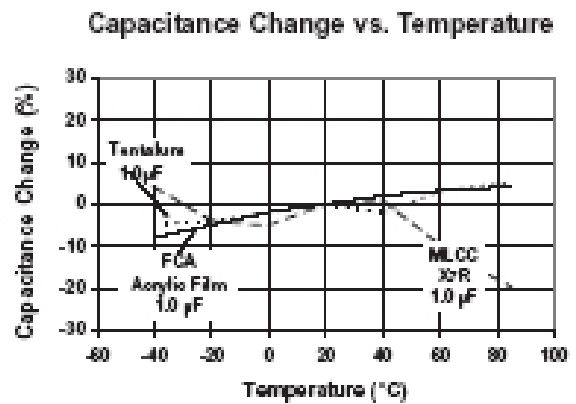
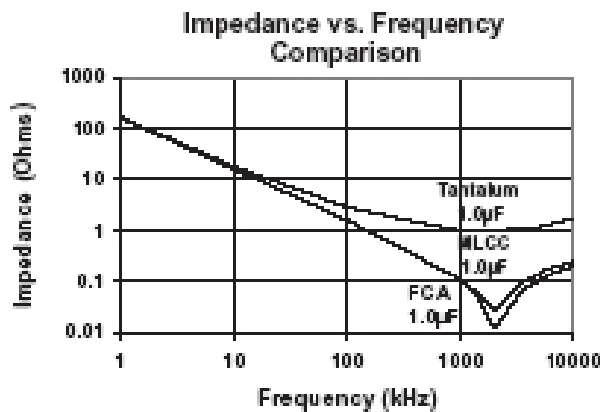

Type FCA capacitors have very low e.s.r. and stable capacitance vs. temperature.

Notice and Disclaimer: All product drawings, descriptions, specifications, statements, information and data (collectively, the "Information") in this datasheet or other publication are subject to change. The customer is responsible for checking, confirming and verifying the extent to which the Information contained in this datasheet or other publication is applicable to an order at the time the order is placed. All Information given herein is believed to be accurate and reliable, but it is presented without any guarantee, warranty, representation or responsibility of any kind, expressed or implied. Statements of suitability for certain applications are based on the knowledge that the Cornell Dubilier company providing such statements ("Cornell Dubilier") has of operating conditions that such Cornell Dubilier company regards as typical for such applications, but are not intended to constitute any guarantee, warranty or representation regarding any such matter – and Cornell Dubilier specifically and expressly disclaims any guarantee, warranty or representation concerning the suitability for a specific customer application, use, storage, transportation, or operating environment. The Information is intended for use only by customers who have the requisite experience and capability to determine the correct products for their application. Any technical advice inferred from this Information or otherwise provided by Cornell Dubilier with reference to the use of any Cornell Dubilier products is given gratis (unless otherwise specified by Cornell Dubilier), and Cornell Dubilier assumes no obligation or liability for the advice given or results obtained. Although Cornell Dubilier strives to apply the most stringent quality and safety standards regarding the design and manufacturing of its products, in light of the current state of the art, isolated component failures may still occur. Accordingly, customer applications which require a high degree of reliability or safety should employ suitable designs or other safeguards (such as installation of protective circuitry or redundancies or other appropriate protective measures) in order to ensure that the failure of an electrical component does not result in a risk of personal injury or property damage. Although all product-related warnings, cautions and notes must be observed, the customer should not assume that all safety measures are indicated in such warnings, cautions and notes, or that other safety measures may not be required.

Mouser Electronics

Authorized Distributor

Click to View Pricing, Inventory, Delivery & Lifecycle Information:

Cornell Dubilier:

[FCA1206C154M-H1](#) [FCA1206C334M-H2](#) [FCA1206C474M-H3](#) [FCA1206C684M-H3](#) [FCA1210C105M-G2](#)
[FCA1206A105M-H3](#) [FCA1206C224M-H1](#) [FCA1210C105M](#) [FCA1206C474M](#) [FCA1206C224M](#)