

SDCH1V80

Semi-shielded power inductors

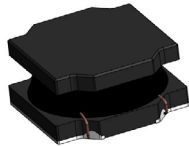

Product features

- High current carrying capacity
- High power density, low core losses
- Magnetically semi-shielded
- 8.3 mm x 8.3 mm surface mount package in 4.2 mm height
- NiZn ferrite magnetic material
- Moisture sensitivity level (MSL): 1

Applications

- DC-DC converters
- Switching controllers
- Industrial IoT equipment
- Game consoles
- Portable electronics
- Laptops, notebooks, and netbooks
- Desktops and workstations
- Battery backup
- LED lighting
- HD televisions and displays

Environmental compliance and general specifications

- Storage temperature range (component): -40 °C to +125 °C
- Operating temperature range: -40 °C to +125 °C (ambient plus self-temperature rise)
- Solder reflow temperature: J-STD-020 (latest revision) compliant



Product specifications

Part number ⁵	OCL ¹ (μ H)	FLL ² (μ H) minimum	I _{rms} ³ (A)	I _{pk} ⁴ (A)	DCR (m Ω) @ +20 °C nominal	DCR (m Ω) @ +20 °C maximum
SDCH1V8040-1R0N-R	1.0±30%	0.46	8.0	12.0	6.5	9
SDCH1V8040-1R5N-R	1.5±30%	0.68	7.3	9.6	7.5	11
SDCH1V8040-2R2M-R	2.2±20%	1.14	6.9	9.3	10	13
SDCH1V8040-3R3M-R	3.3±20%	1.72	5.0	8.6	15	19
SDCH1V8040-4R7M-R	4.7±20%	2.44	4.7	6.3	18	21
SDCH1V8040-6R8M-R	6.8±20%	3.54	3.8	5.1	26	30
SDCH1V8040-100M-R	10±20%	5.2	3.0	4.6	40	46
SDCH1V8040-150M-R	15±20%	7.8	2.8	3.2	50	58
SDCH1V8040-220M-R	22±20%	11.44	2.5	2.8	70	81
SDCH1V8040-330M-R	33±20%	17.16	1.9	2.2	110	127
SDCH1V8040-470M-R	47±20%	24.44	1.8	2.0	140	161
SDCH1V8040-680M-R	68±20%	35.36	1.3	1.6	215	247
SDCH1V8040-101M-R	100±20%	52.0	1.1	1.22	300	345
SDCH1V8040-221M-R	220±20%	114.4	0.75	0.9	680	782
SDCH1V8040-331M-R	330±20%	171.6	0.6	0.7	1000	1150
SDCH1V8040-471M-R	470±20%	244.4	0.5	0.65	1500	1725
SDCH1V8040-681M-R	680±20%	353.6	0.42	0.53	2200	2530
SDCH1V8040-821M-R	820±20%	426.4	0.4	0.45	2500	2875
SDCH1V8040-102M-R	1000±20%	520.0	0.37	0.42	2900	3335

1. Open circuit inductance (OCL) test parameters: 100 kHz, 0.25 Vrms, 0.0 Adc, +25 °C

2. Full load inductance (FLL) test parameters: 100 kHz, 0.25 Vrms, I_{pk}, +25 °C

3. I_{rms}: DC current for an approximate temperature rise of 40 °C without core loss. Derating is necessary for AC currents. PCB layout, trace thickness and width, air-flow, and proximity of other heat generating components will affect the temperature rise. It is recommended that the temperature of the part not exceed +125 °C under worst case operating conditions verified in the end application.

4. I_{pk}: Peak current for approximately 35% maximum rolloff @ +25 °C

5. Part number definition: SDCH1Vxxx-yyyz-R

SDCH1V = Product code

xxx= size code

yyy= Inductance value in μ H, R=decimal point

z= Inductance tolerance

-R suffix = RoHS compliant

Dimensions-mm

SDCH1V8040

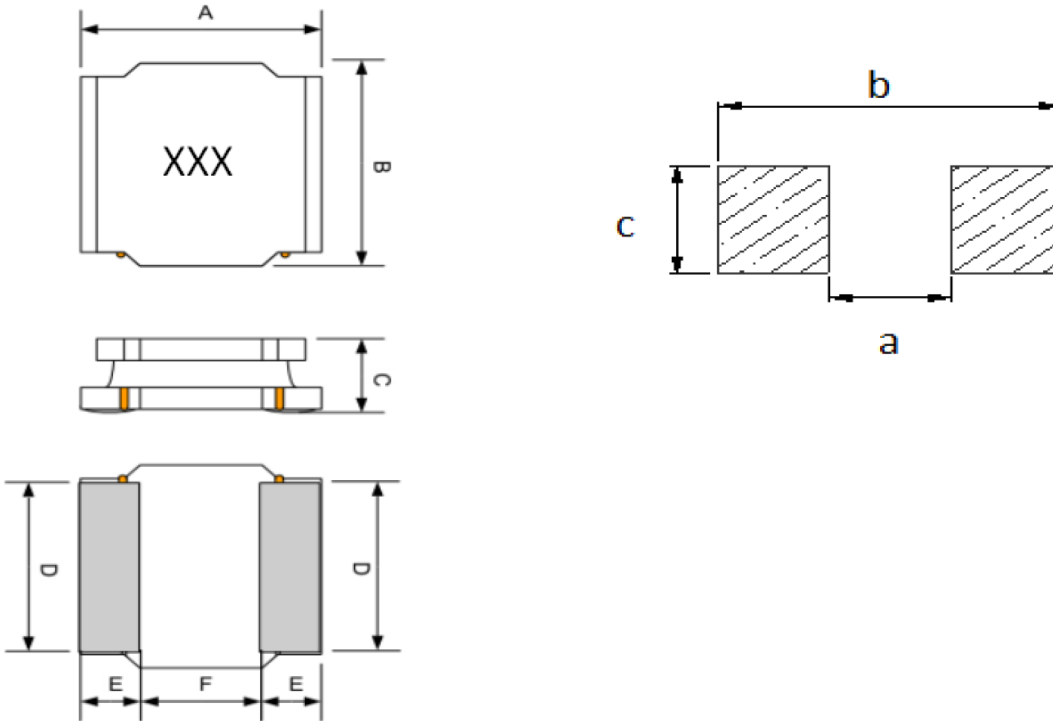

Dimension	Value
A	8.0 ± 0.3
B	8.0 ± 0.3
C	4.2 MAX
D	6.3 ± 0.2
E	2.45 ± 0.3
F	3.1 ± 0.3
a	2.8 TYP
b	8.3 TYP
c	6.6 TYP

Part marking: xxx= inductance value in μH , R= decimal point. If no R is present then last character equals number of zeros.
 Tolerances are ± 0.3 millimeters unless stated otherwise
 All soldering surfaces to be coplanar within 0.1 millimeters
 Pad layout tolerances are ± 0.1 millimeters unless stated otherwise
 Traces or vias underneath the inductor is not recommended

Packaging information- mm

SDCH1V8040

Supplied in tape and reel packaging, 1000 parts per 13" diameter reel (EIA-481 compliant)

Drawing not to scale

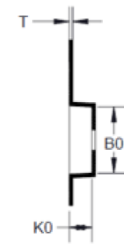
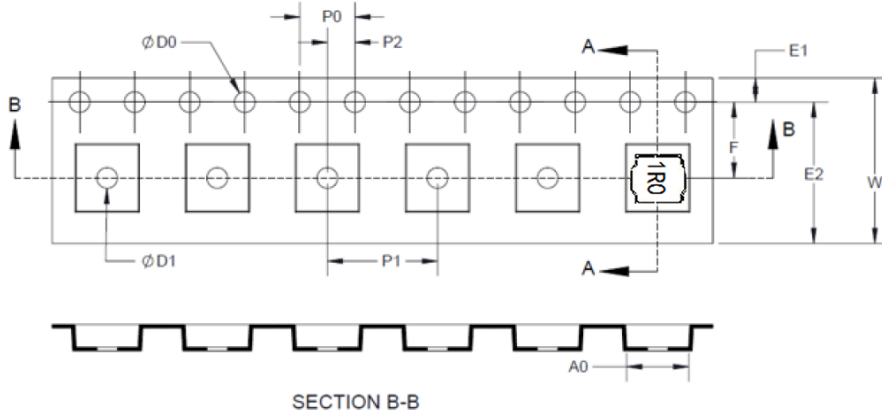

SECTION A-A

Dimension	Value
W	16.00 + 0.20/-0.30
F	7.50 ± 0.10
E1	1.75 ± 0.10
E2	N/A
P0	4.00 ± 0.10
P1	12.00 ± 0.10
P2	2.00 ± 0.10
ØD0	1.55 ± 0.05
ØD1	1.55 ± 0.05
A0	8.55 ± 0.10
B0	8.55 ± 0.10
K0	4.40 ± 0.10
T	0.40 ± 0.05

Inductance and temperature rise vs current

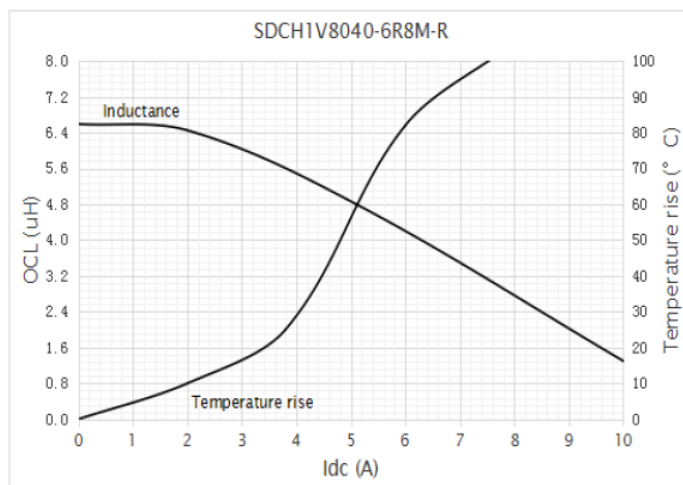
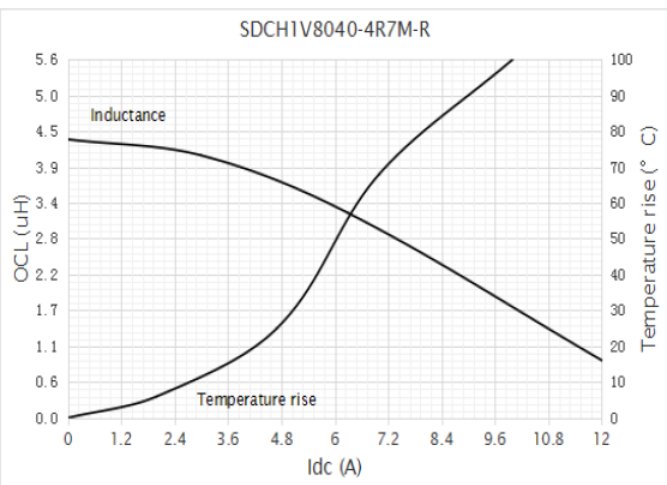
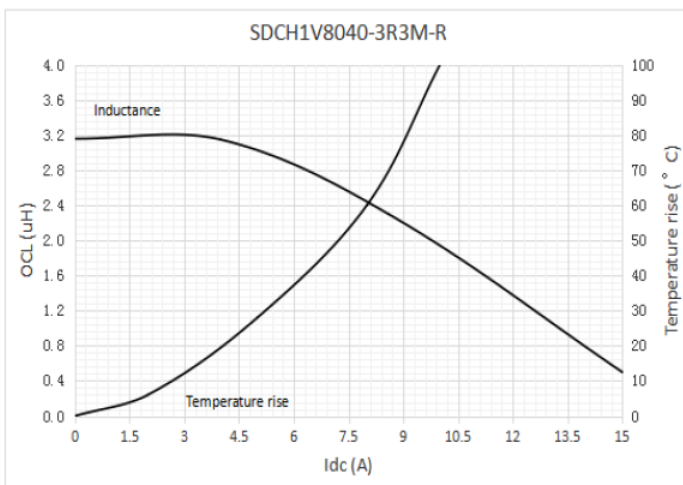
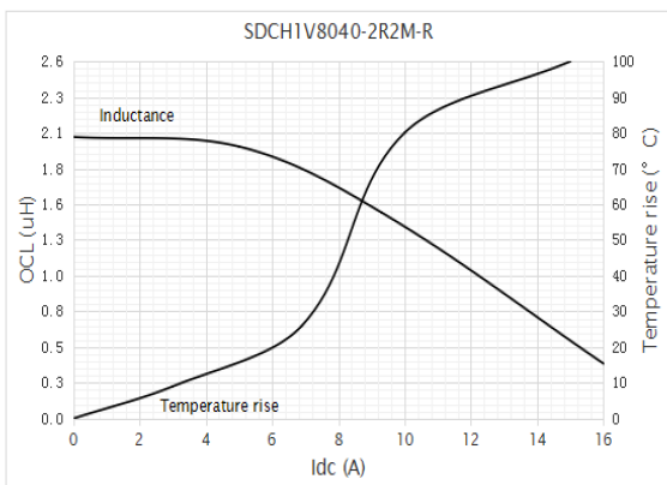
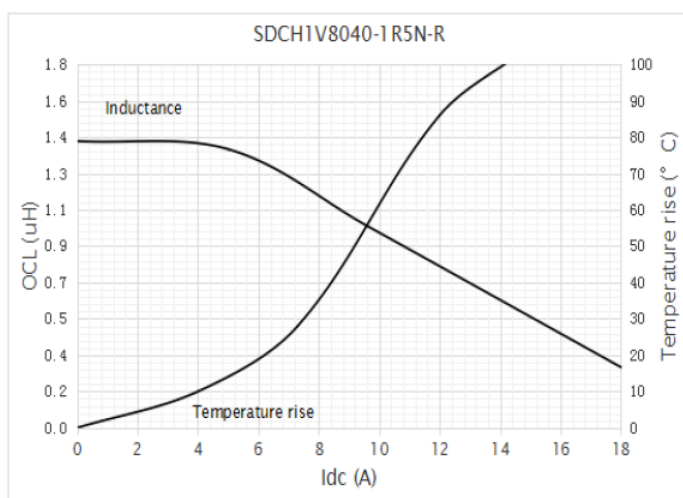
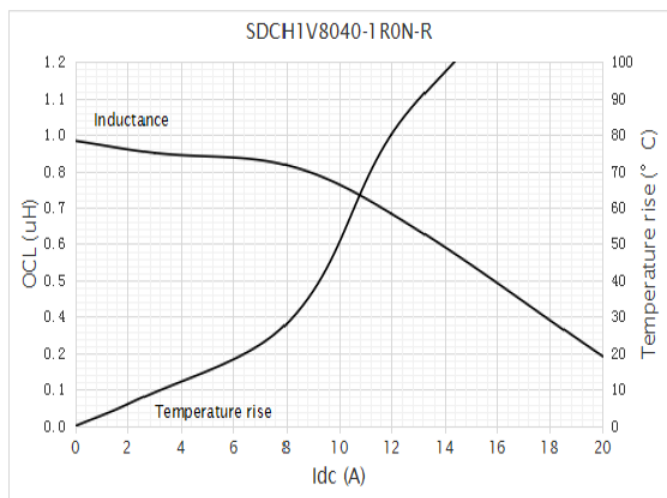

Inductance and temperature rise vs current

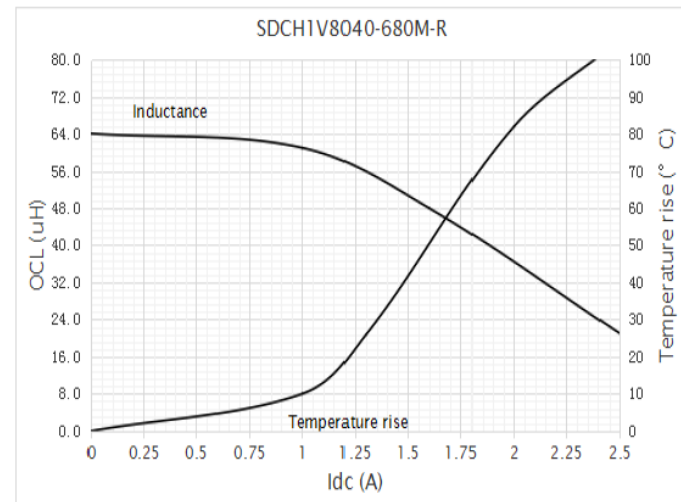
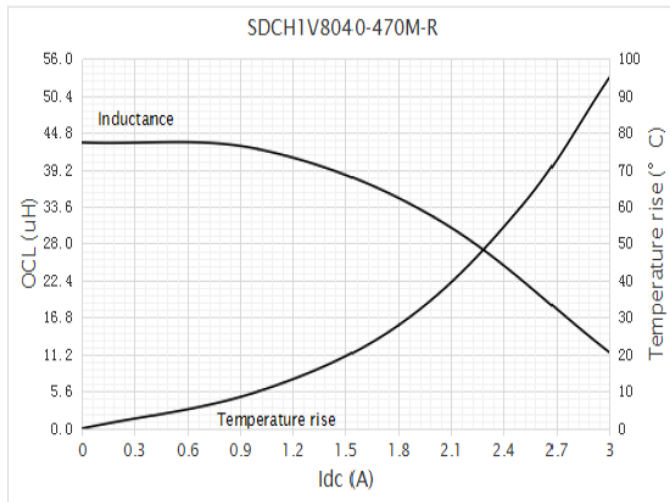
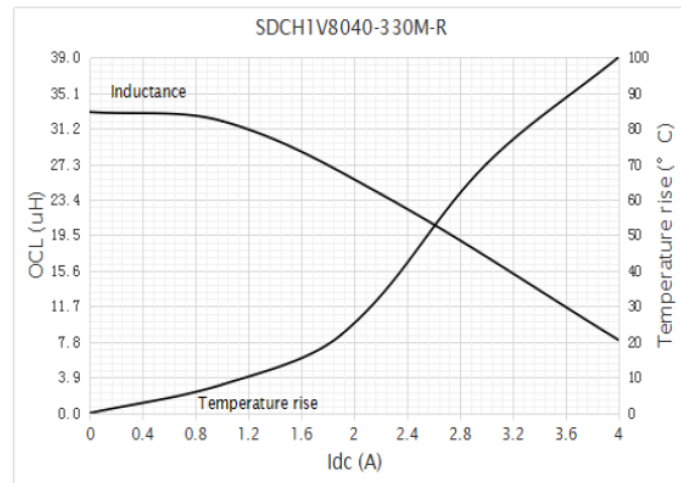
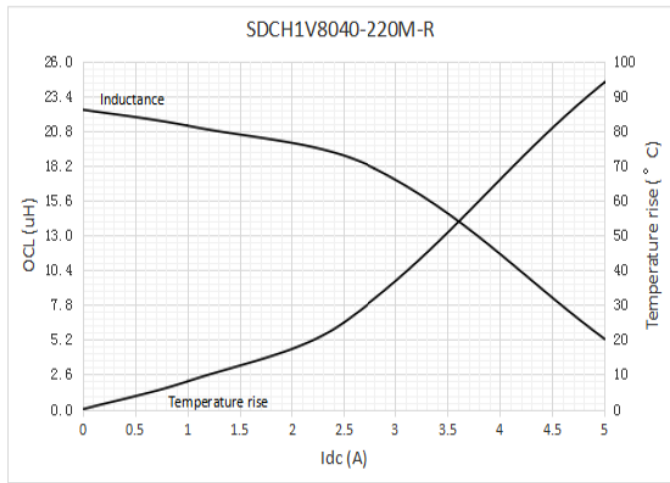
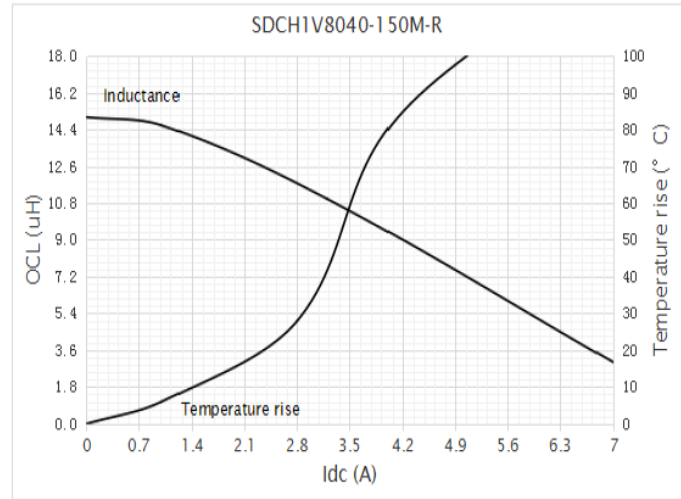
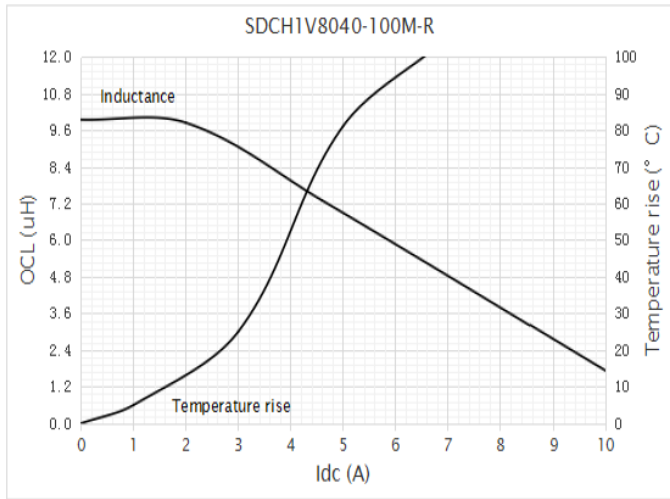

Inductance and temperature rise vs current

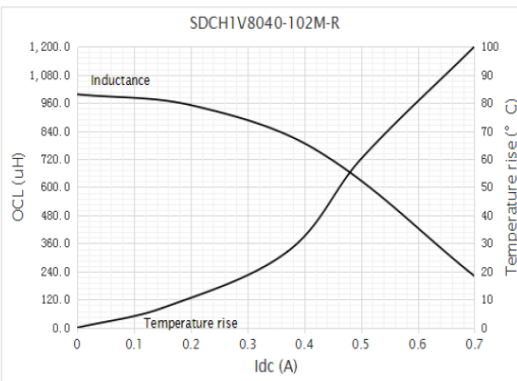
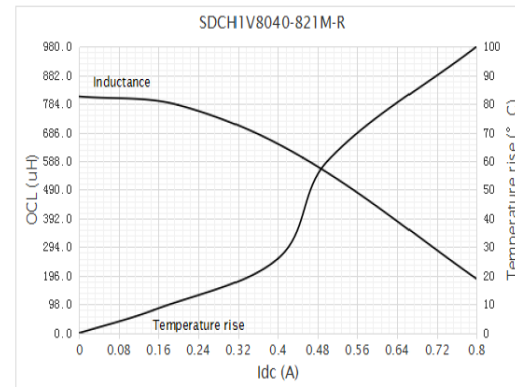
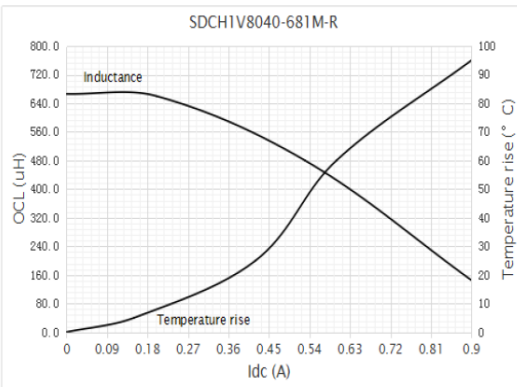
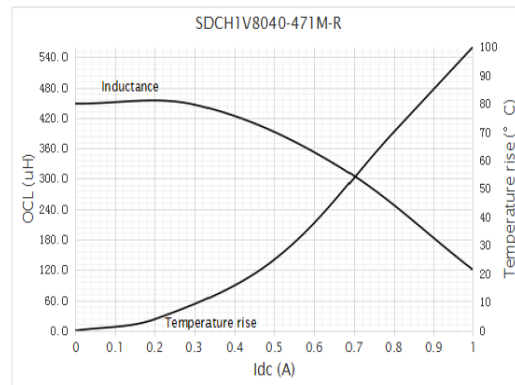
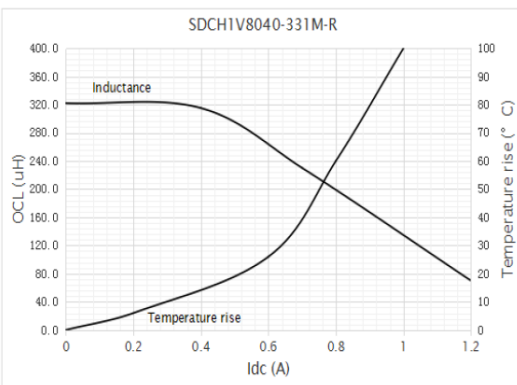
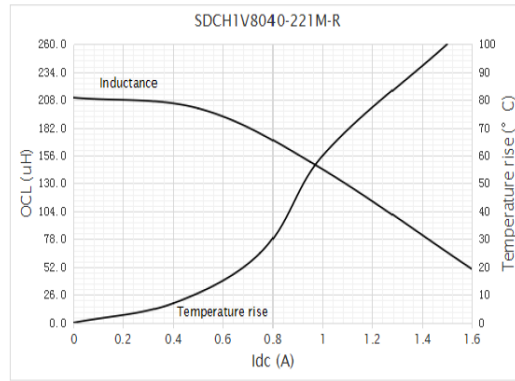
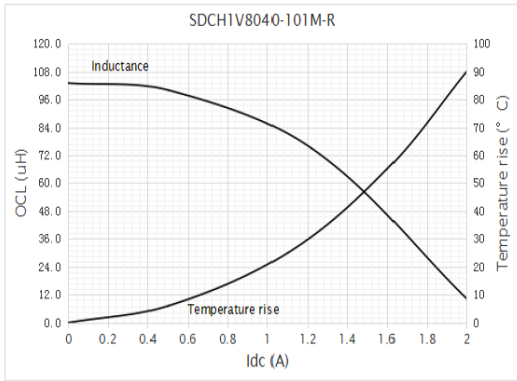

Solder reflow profile

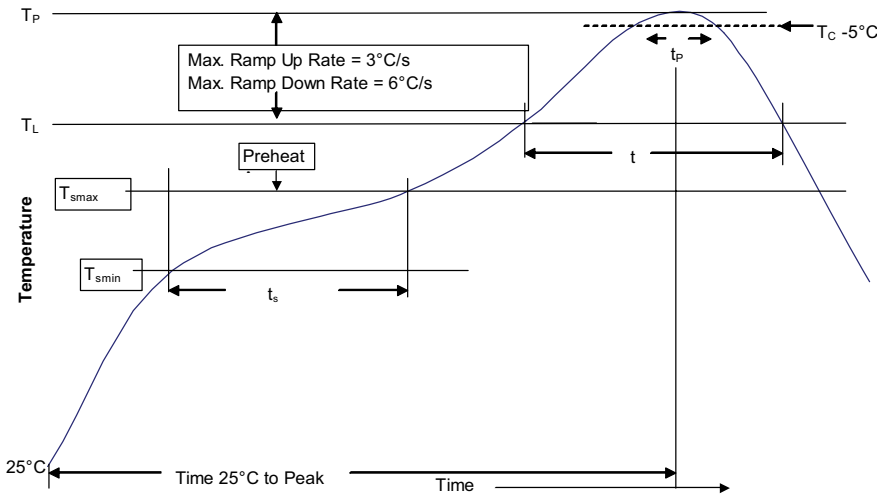

Table 1 - Standard SnPb solder (T_C)

Package thickness	Volume mm^3 <350	Volume mm^3 \geq 350
<2.5 mm)	235 °C	220 °C
\geq 2.5 mm	220 °C	220 °C

Table 2 - Lead (Pb) free solder (T_C)

Package thickness	Volume mm^3 <350	Volume mm^3 350 - 2000	Volume mm^3 >2000
<1.6 mm	260 °C	260 °C	260 °C
1.6 – 2.5 mm	260 °C	250 °C	245 °C
>2.5 mm	250 °C	245 °C	245 °C

Reference J-STD-020

Profile feature	Standard SnPb solder	Lead (Pb) free solder
Preheat and soak		
• Temperature min. (T_{smin})	100 °C	150 °C
• Temperature max. (T_{smax})	150 °C	200 °C
• Time (T_{smin} to T_{smax}) (t_s)	60-120 seconds	60-120 seconds
Ramp up rate T_L to T_p	3 °C/ second max.	3 °C/ second max.
Liquidous temperature (T_L)	183 °C	217 °C
Time (t_L) maintained above T_L	60-150 seconds	60-150 seconds
Peak package body temperature (T_p)*	Table 1	Table 2
Time (t_p)* within 5 °C of the specified classification temperature (T_C)	20 seconds*	30 seconds*
Ramp-down rate (T_p to T_L)	6 °C/ second max.	6 °C/ second max.
Time 25 °C to peak temperature	6 minutes max.	8 minutes max.

* Tolerance for peak profile temperature (T_p) is defined as a supplier minimum and a user maximum.

Life Support Policy: Eaton does not authorize the use of any of its products for use in life support devices or systems without the express written approval of an officer of the Company. Life support systems are devices which support or sustain life, and whose failure to perform, when properly used in accordance with instructions for use provided in the labeling, can be reasonably expected to result in significant injury to the user.

Eaton reserves the right, without notice, to change design or construction of any products and to discontinue or limit distribution of any products. Eaton also reserves the right to change or update, without notice, any technical information contained in this bulletin.

Eaton
Electronics Division
1000 Eaton Boulevard
Cleveland, OH 44122
United States
Eaton.com/electronics

© 2021 Eaton
All Rights Reserved
Printed in USA
Publication No. ELX1035 BU-ELX21035
April 2021

Eaton is a registered trademark.
All other trademarks are property of their respective owners.

Follow us on social media to get the latest product and support information.



Mouser Electronics

Authorized Distributor

Click to View Pricing, Inventory, Delivery & Lifecycle Information:

Eaton:

[SDCH1V8040-100M-R](#) [SDCH1V8040-101M-R](#) [SDCH1V8040-102M-R](#) [SDCH1V8040-150M-R](#) [SDCH1V8040-1R0N-R](#) [SDCH1V8040-1R5N-R](#) [SDCH1V8040-821M-R](#) [SDCH1V8040-470M-R](#) [SDCH1V8040-471M-R](#) [SDCH1V8040-4R7M-R](#) [SDCH1V8040-680M-R](#) [SDCH1V8040-681M-R](#) [SDCH1V8040-6R8M-R](#) [SDCH1V8040-220M-R](#) [SDCH1V8040-221M-R](#) [SDCH1V8040-2R2M-R](#) [SDCH1V8040-330M-R](#) [SDCH1V8040-331M-R](#) [SDCH1V8040-3R3M-R](#)