

# XL Style Photovoltaic Fuses

50 to 630A, 1000 & 1500Vdc PV Series

RoHS

## Catalog Symbols

1000Vdc

PV-(amp rating)A(size)XL (bladed)

PV-(amp rating)A(size)XL-B (bolted)

1500Vdc

PV-(amp rating)A(size)XL-15 (bladed)

PV-(amp rating)A(size)XL-B-15 (bolted)

## Class of Operation

gPV and UL PV fuses

## Fuse Sizes

01XL, 1XL, 2XL and 3L

## Fuse Holders

SD1XL-S (suitable for 01 and 1XL)

SD2XL-S (suitable for 2XL)

SD3L-S (suitable for 3L)

## Optional Microswitches

Bladed fuses: 170H0235 or 170H0237 for 01XL

170H0236 or 170H0238 for 1XL, 2XL and 3L

Bolted fuses: 170H0069 for all sizes

## Agency Information

IEC 60269-6, UL 2579, E335324, RoHS, CSA pending, CCC pending



## Description

A range of XL package fuses specifically designed for protecting and isolating photovoltaic array combiners and disconnects. These fuses are capable of interrupting low overcurrents associated with faulted PV systems (reverse current, multi-array fault).

## Packaging

MOQ: 1 (100% recyclable)

## Technical Data

Ratings:

Time Constant 1-3mS

Volts	Amps	IR	Size
1000Vdc	63-160	50kA	01
	160-335	33kA	1, 2
	350-630*	50kA	3
1200Vdc	160	30kA	01
1500Vdc	50-400	30kA	01, 1, 2, 3

\* 630A Thermally rated to UL only.

## Dimensions - mm

Bladed - Size 01XL, 1XL, 2XL and 3L

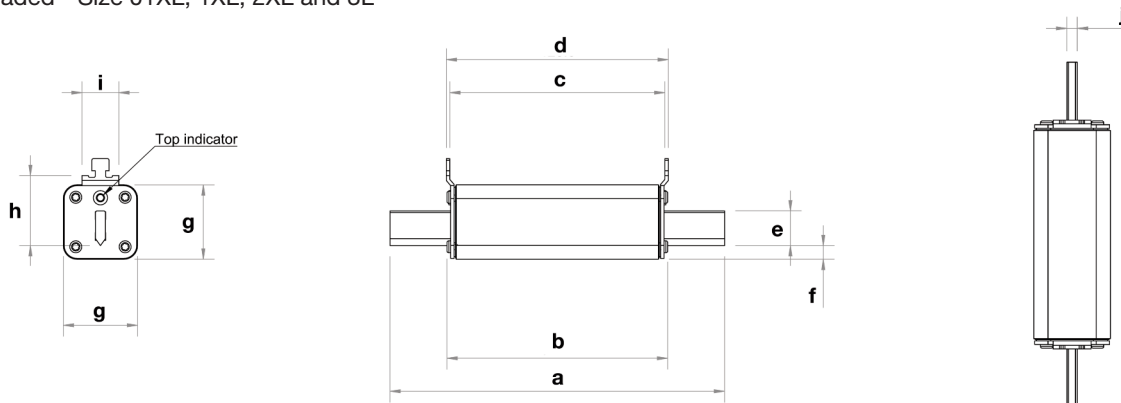

Size	a	b	c	d	e	f	g	h	i	j
01XL	193.8	127.8	124.6	128.6	20	7.9	43	40.4	21.3	5.8
1XL	189.8	127.8	119.6	123.6	20	13.4	51	39.8	20	5.8
2XL	204.5	128.5	119.3	123.3	26	14.38	59.2	47.9	20	5.8
3L	204.9	127.5	118.3	122.3	32.3	18.7	73.5	60	22	6

# XL Style Photovoltaic Fuses

50 to 630A, 1000 & 1500Vdc PV Series



## Dimensions - mm

Bolted - Size 01XL, 1XL and 2XL

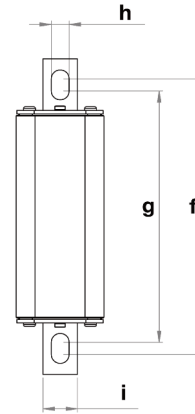
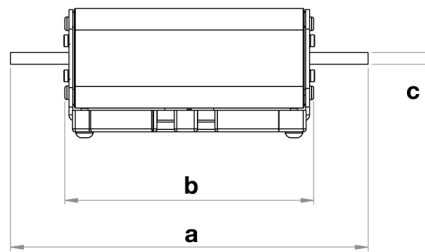
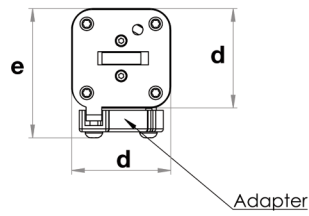

Size	a	b	c	d	e	f	g	h	i
01XL	187.6	127.8	6	43	58.3	164.3	150.3	10.4	20
1XL	183.6	127.8	6	51	66.3	160.3	146.3	10.4	20
2XL	191.3	128.5	6	59.2	74.5	167.8	154.8	10.5	25

Bolted - Size 3L

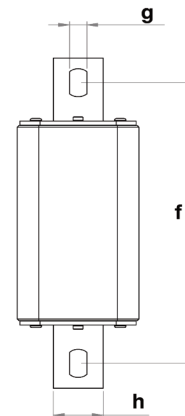
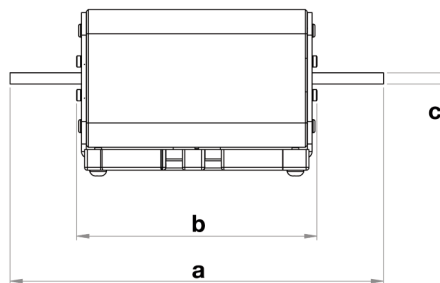
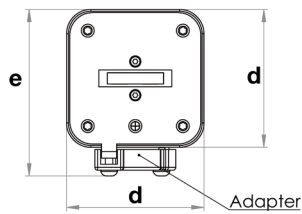

Size	a	b	c	d	e	f	g	h
3L	199.7	128.5	6	73.5	88.8	169.7	10.5	30

# XL Style Photovoltaic Fuses

50 to 630A, 1000 & 1500Vdc PV Series



## Technical Data - 1000Vdc

Part Number		Body Size	Current Rating (Amps)	Voltage	Energy Integrals It (A·s)		Watts Loss	
Bladed Version	Bolted Version				Pre-Arcing	Total at 1000V	0.8 I <sub>n</sub>	I <sub>n</sub>
PV-63A-01XL	PV-63A-01XL-B	01	63	1000Vdc	260	1900	13	24
PV-80A-01XL	PV-80A-01XL-B		80		490	3600	17	29
PV-100A-01XL	PV-100A-01XL-B		100		870	6300	18	32
PV-125A-01XL	PV-125A-01XL-B		125		1930	13,900	20	40
PV-160A-01XL	PV-160A-01XL-B		160		3900	28,100	22	44
PV-200A-1XL	PV-200A-1XL-B	1	200	1000Vdc	9400	27,260	31	54
PV-160A-2XL	PV-160A-2XL-B	2	160	1000Vdc	2780	21,000	25	44
PV-200A-2XL	PV-200A-2XL-B		200		4950	37,000	28	50
PV-250A-2XL	PV-250A-2XL-B		250		9450	70,000	34	60
PV-315A-2XL	PV-315A-2XL-B		315		16,600	123,000	40	66
PV-355A-2XL	PV-355A-2XL-B		355		26,000	192,000	42	68
PV-350A-3L	PV-350A-3L-B	3	350	1000Vdc	31,000	161,200	40	65
PV-400A-3L	PV-400A-3L-B		400		44,500	231,400	48	82
PV-500A-3L	PV-500A-3L-B		500		85,000	442,000	50	85
PV-600A-3L	PV-600A-3L-B		600		137,000	712,400	80	108
PV-630A-3L*	PV-630A-3L-B*		630*		137,000	712,400	92	118

\* 630A Thermally rated to UL only.

## Technical Data - 1500Vdc\*\*

Part Number		Body Size	Current Rating (Amps)	Voltage	Energy Integrals It (A·s)		Watts Loss	
Bladed Version	Bolted Version				Pre-Arcing	Total at 1500V**	0.8 I <sub>n</sub>	I <sub>n</sub>
PV-50A-01XL-15	PV-50A-01XL-B-15	01	50	1500Vdc	175	1000	14	25
PV-63A-01XL-15	PV-63A-01XL-B-15		63		362	2250	15	26
PV-80A-01XL-15	PV-80A-01XL-B-15		80		565	3300	19	35
PV-100A-01XL-15	PV-100A-01XL-B-15		100		1100	6600	22	40
PV-125A-01XL-15	PV-125A-01XL-B-15		125		2200	10,500	23	42
PV-160A-01XL-12	PV-160A-01XL-B-12		160	1200Vdc	5000	24,000	26	52
PV-100A-1XL-15	PV-100A-1XL-B-15	1	100	1500Vdc	1250	6000	24	43
PV-125A-1XL-15	PV-125A-1XL-B-15		125		1950	9360	25	52
PV-160A-1XL-15	PV-160A-1XL-B-15		160		4200	20,160	30	58
PV-200A-1XL-15	PV-200A-1XL-B-15		200		9400	45,120	31	61
PV-125A-2XL-15	PV-125A-2XL-B-15	2	125	1500Vdc	2200	8000	25	44
PV-160A-2XL-15	PV-160A-2XL-B-15		160		5000	17,500	29	48
PV-200A-2XL-15	PV-200A-2XL-B-15		200		8800	28,500	32	57
PV-250A-2XL-15	PV-250A-2XL-B-15		250		16,600	50,000	40	70
PV-250A-3L-15	PV-250A-3L-B-15	3	250	1500Vdc	20,300	92,000	32	50
PV-315A-3L-15	PV-315A-3L-B-15		315		38,000	160,000	36	66
PV-355A-3L-15	PV-355A-3L-B-15		355		44,500	184,000	44	80
PV-400A-3L-15	PV-400A-3L-B-15		400		58,000	240,000	49	91

\*\*1200Vdc for 160A.

# XL Style Photovoltaic Fuses

50 to 630A, 1000 & 1500Vdc PV Series



## Time-Current Characteristics 01XL and 1XL 1000Vdc

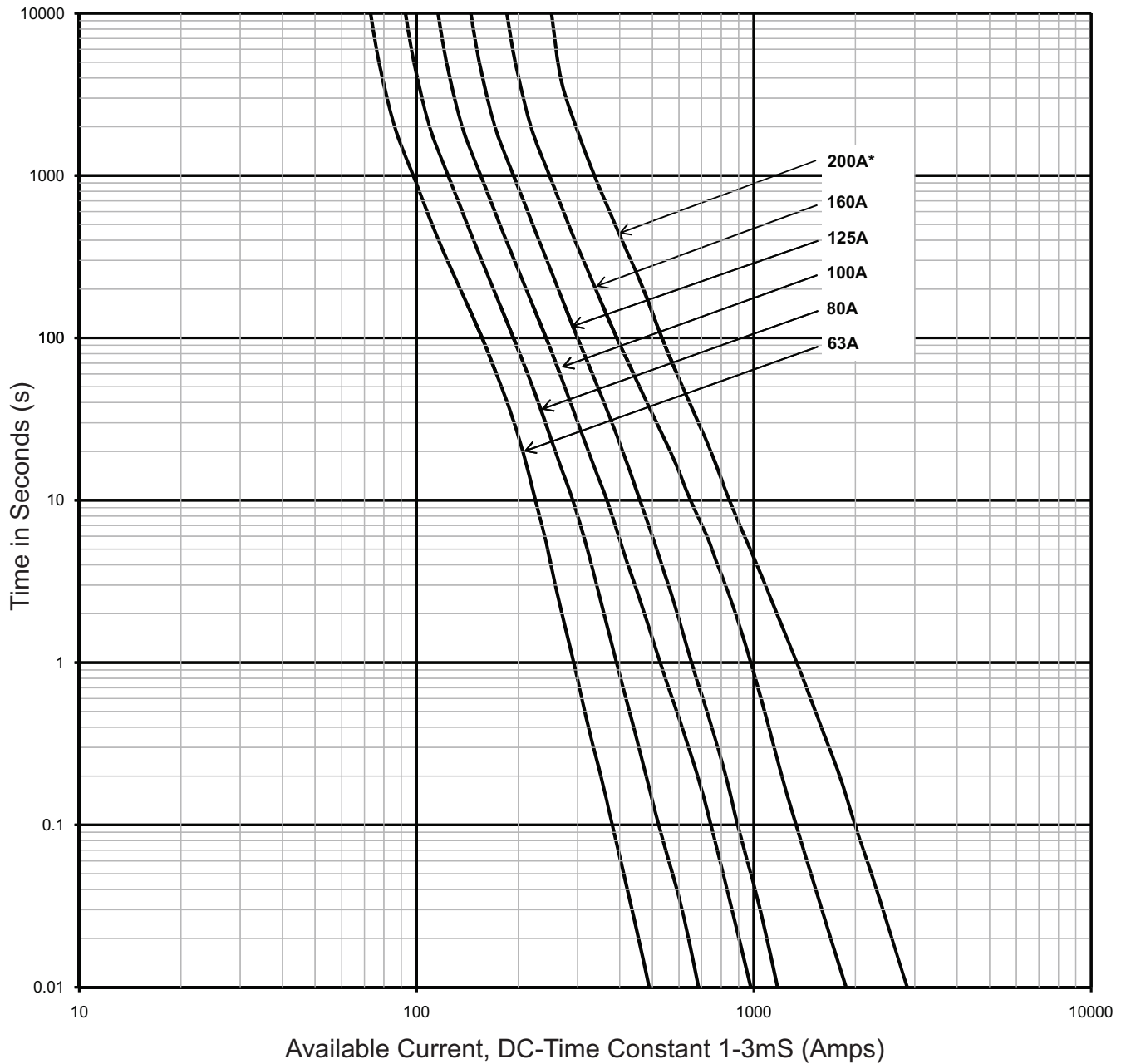

\* Size 1XL only.

# XL Style Photovoltaic Fuses

50 to 630A, 1000 & 1500Vdc PV Series



## Time-Current Characteristics 2XL 1000Vdc

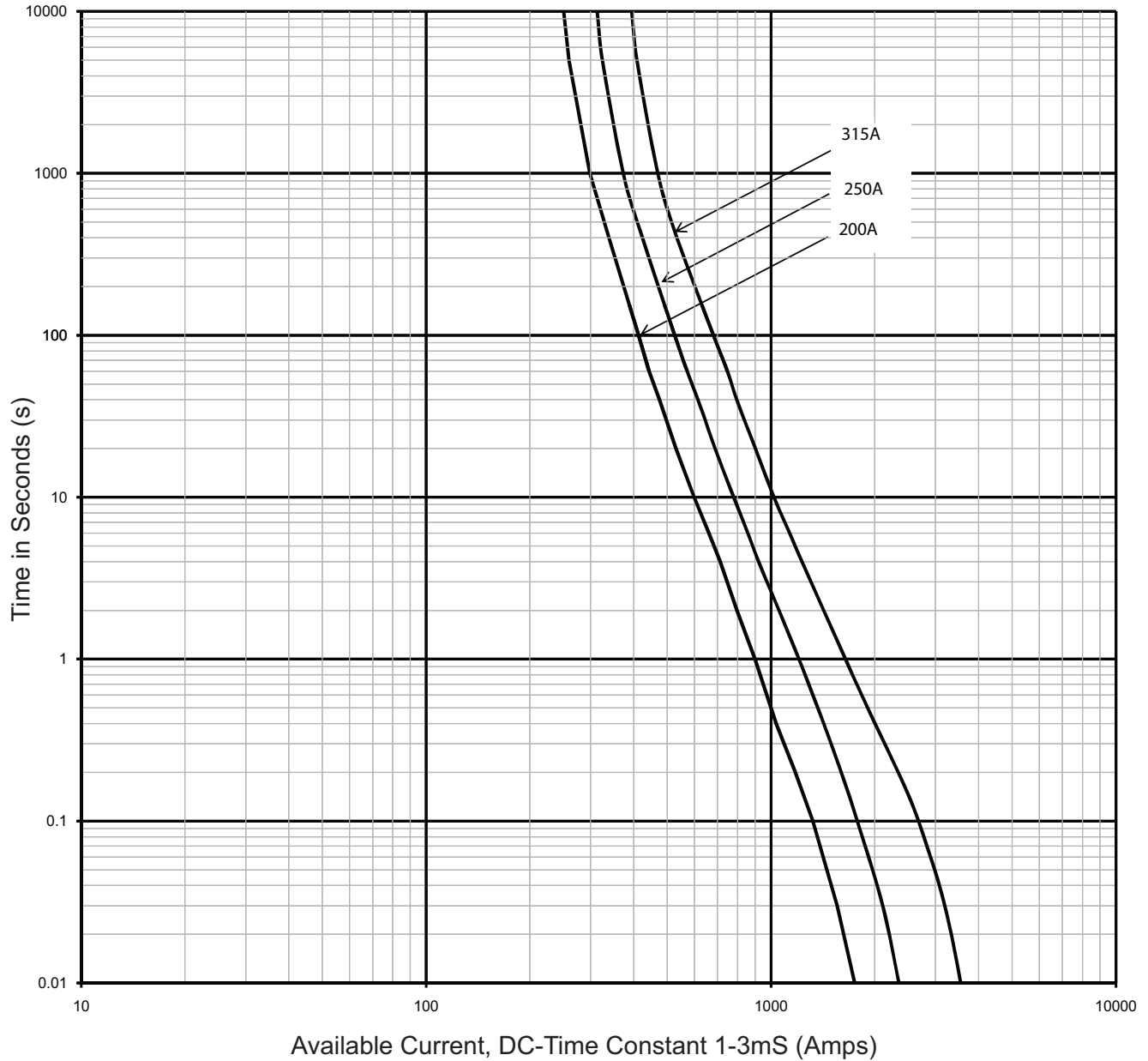

# XL Style Photovoltaic Fuses

50 to 630A, 1000 & 1500Vdc PV Series



## Time-Current Characteristics 3L 1000Vdc

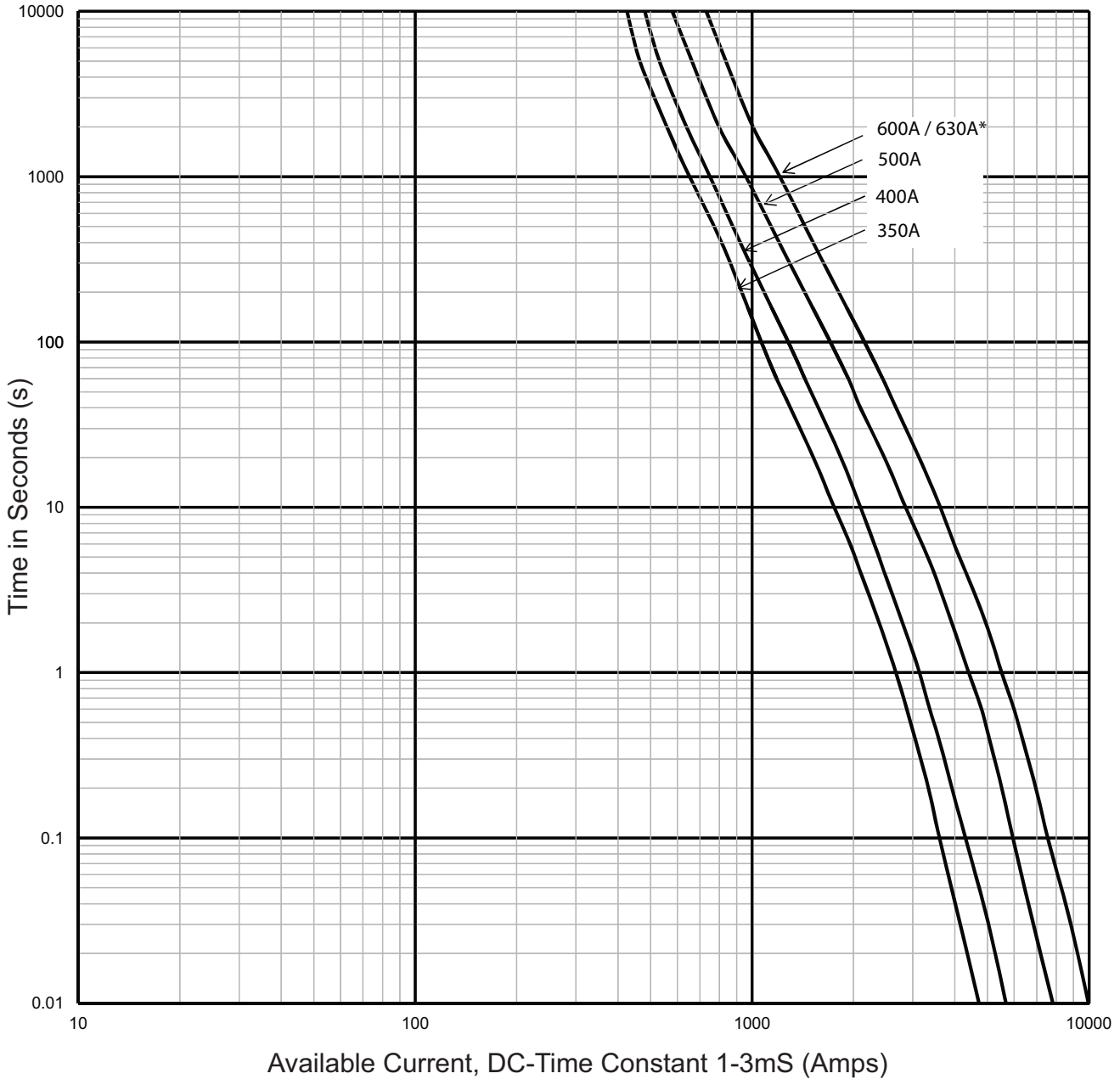

\* 630A Thermally rated to UL only.

# XL Style Photovoltaic Fuses

50 to 630A, 1000 & 1500Vdc PV Series



## Time-Current Characteristics 01XL 1500Vdc

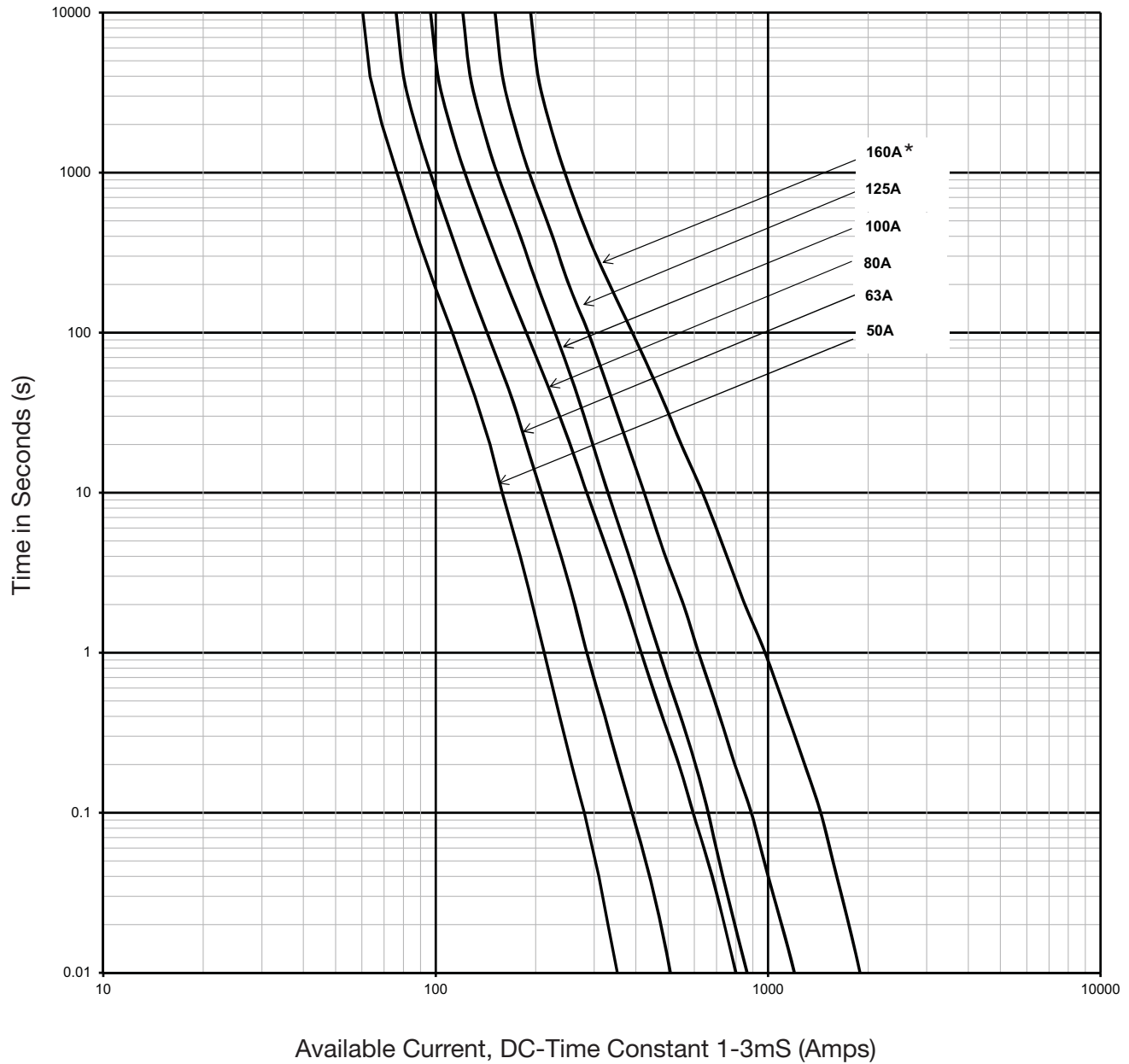

\*160A 1200Vdc.

# XL Style Photovoltaic Fuses

50 to 630A, 1000 & 1500Vdc PV Series



## Time-Current Characteristics 1XL 1500Vdc

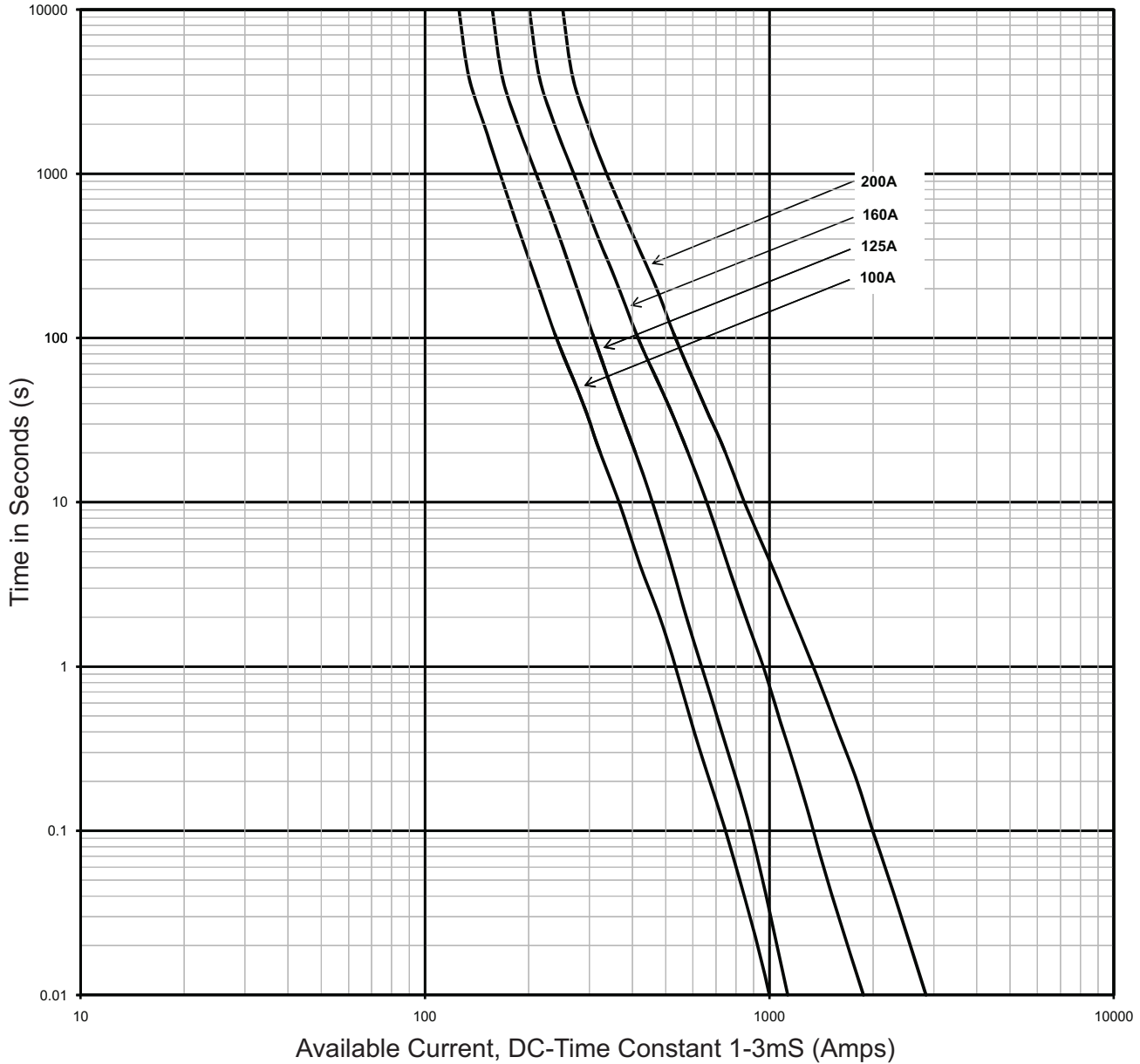



# XL Style Photovoltaic Fuses

50 to 630A, 1000 & 1500Vdc PV Series



## Time-Current Characteristics 2XL 1500Vdc

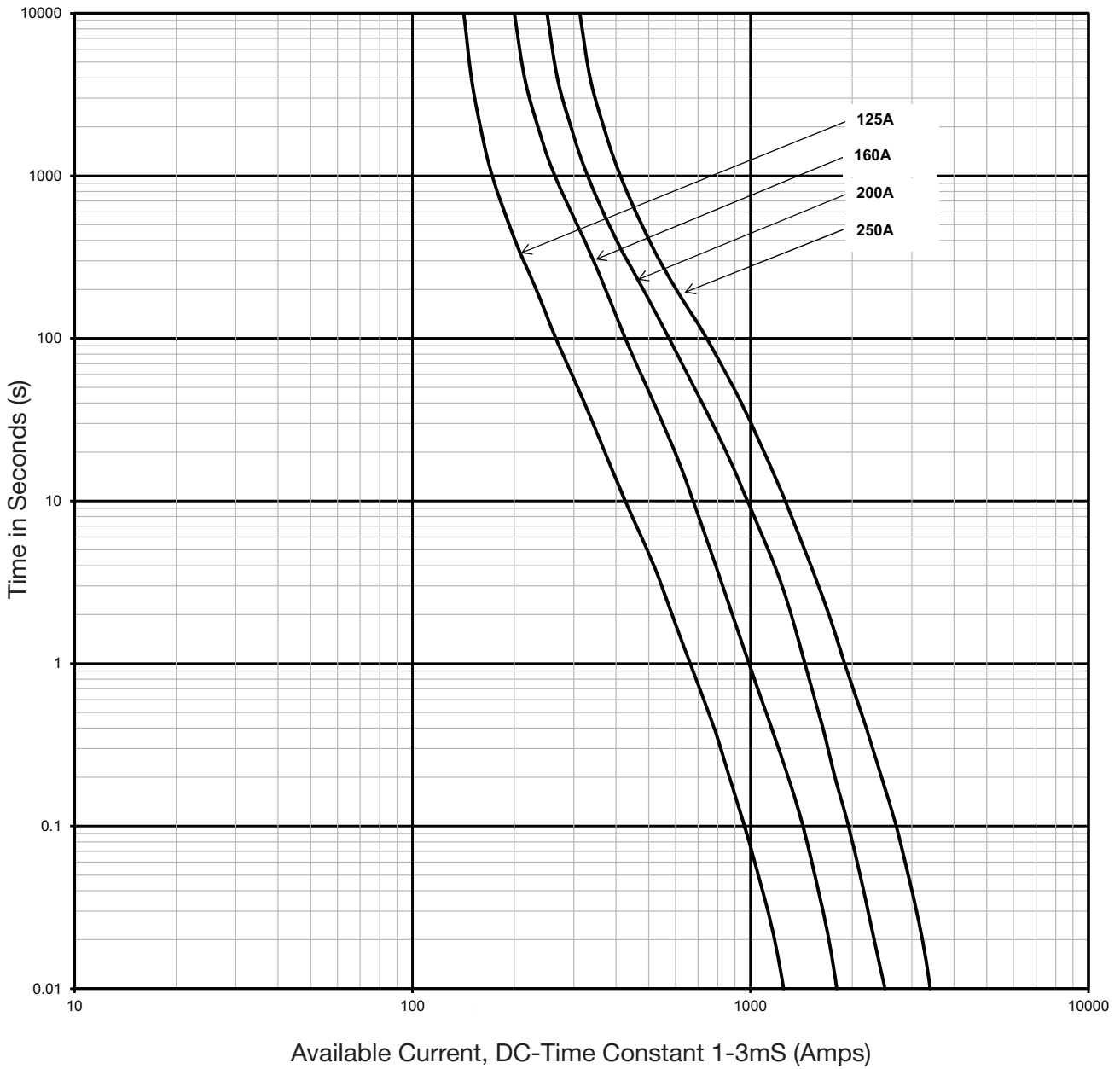

# XL Style Photovoltaic Fuses

50 to 630A, 1000 & 1500Vdc PV Series



## Time-Current Characteristics 3L 1500Vdc

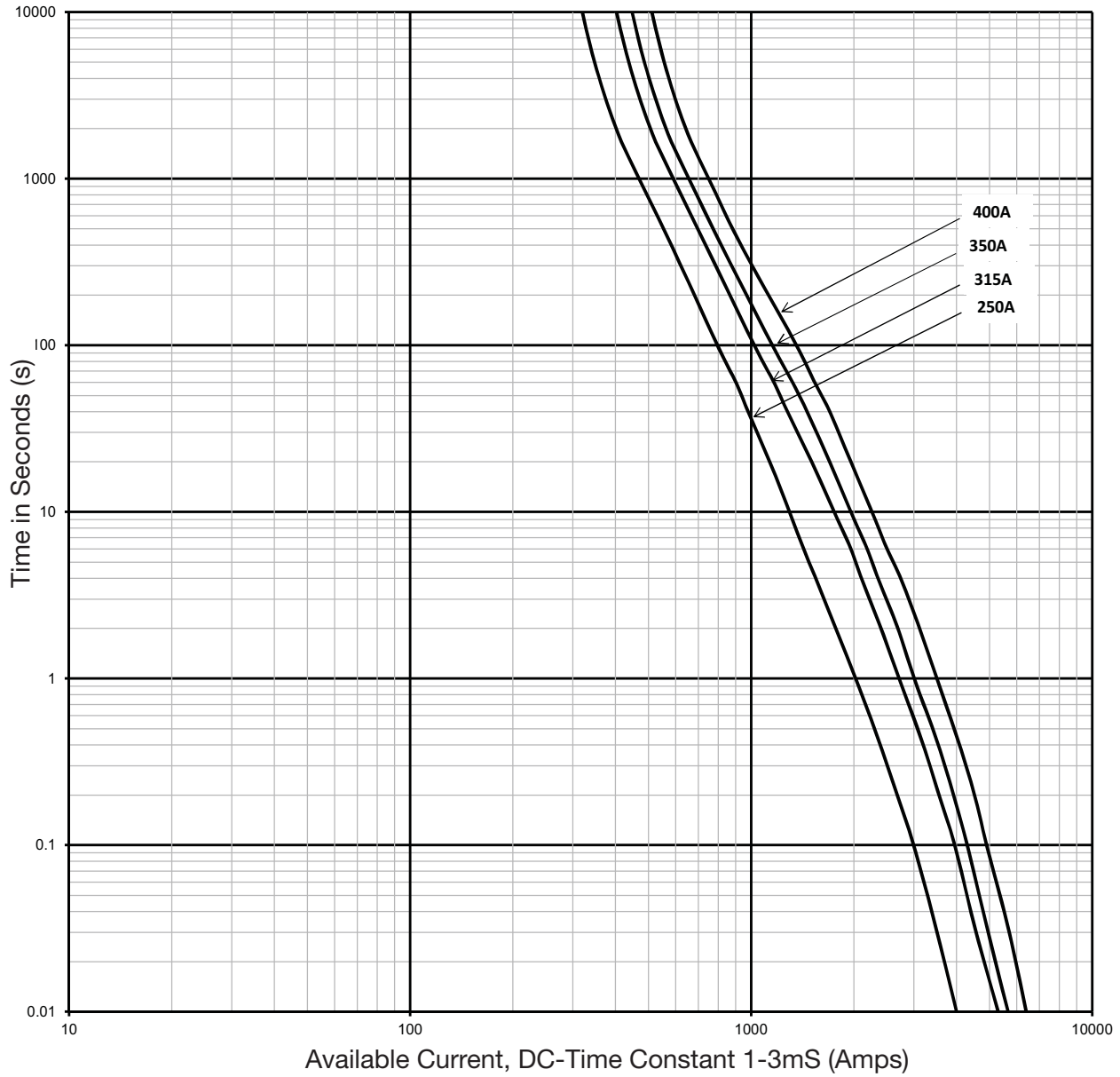

# XL Style Photovoltaic Fuses

50 to 630A, 1000 & 1500Vdc PV Series



## Temperature Derating

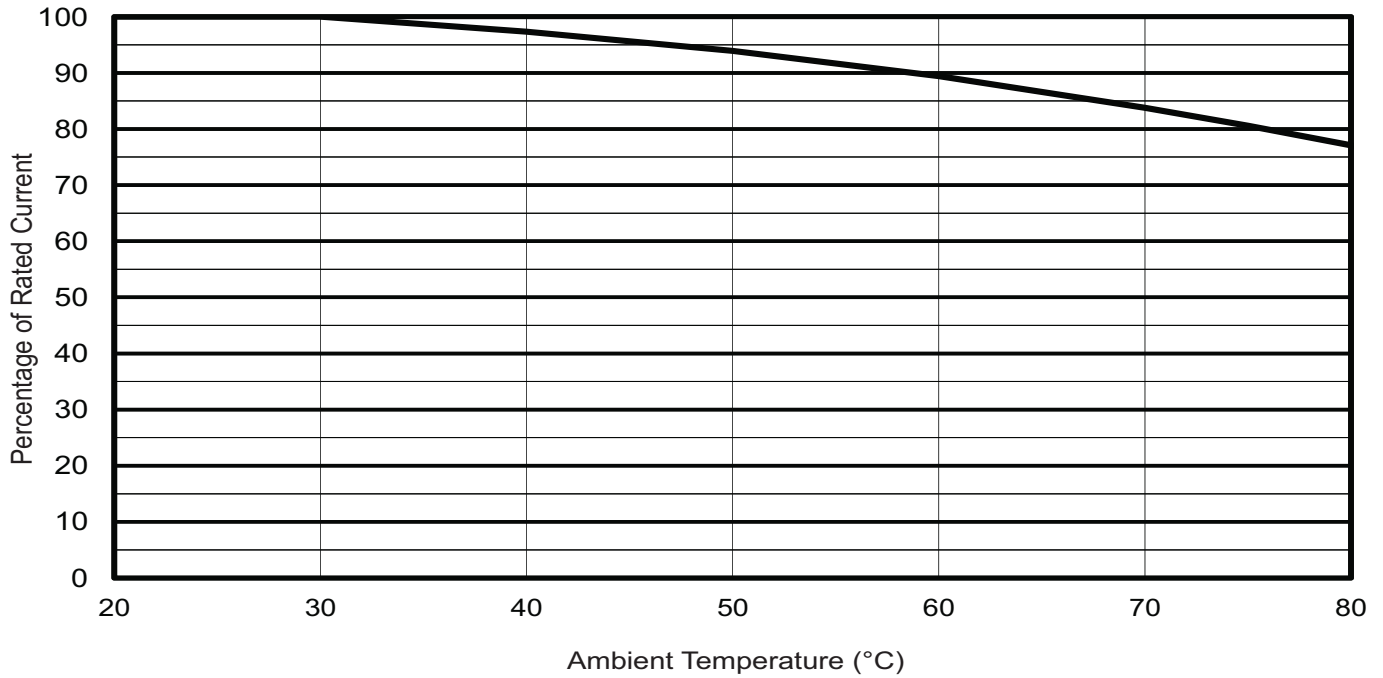

The only controlled copy of this Data Sheet is the electronic read-only version located on the Cooper Bussmann Network Drive. All other copies of this document are by definition uncontrolled. This bulletin is intended to clearly present comprehensive product data and provide technical information that will help the end user with design applications. Cooper Bussmann reserves the right, without notice, to change design or construction of any products and to discontinue or limit distribution of any products. Cooper Bussmann also reserves the right to change or update, without notice, any technical information contained in this bulletin. Once a product has been selected, it should be tested by the user in all possible applications.

# Mouser Electronics

Authorized Distributor

Click to View Pricing, Inventory, Delivery & Lifecycle Information:

[Eaton:](#)

[PV-350A-3L-B](#) [PV-315A-3L-B-15](#) [PV-500A-3L-B](#) [PV-315A-2XL-B](#) [PV-600A-3L-B](#) [PV-63A-01XL-B-15](#) [PV-100A-01XL](#) [PV-125A-01XL](#) [PV-100A-01XL-B](#) [PV-50A-01XL-B-15](#) [PV-400A-3L-B-15](#)