



Strato Pi Fan User Guide

February 2021

Revision 001

SPBF10X Strato Pi Fan



Safety information	3
Qualified personnel	3
Hazard levels	3
Safety instructions	4
General safety instructions	4
Introduction	5
Features	5
Usage and connections	6
Hardware Installation	6
Device identification	7
Power supply	7
GPIO pins	8
I2C header	8
Software installation and configuration	9
Raspberry Pi OS kernel module	9
Using Strato Pi Fan	10
I2C Control	10
Thermal considerations	12
Circuit schematic	14
Technical specifications	15
Disposal	16
Installation and use restrictions	16
Standards and regulations	16
Safety instructions	16
Set-up	16
Conformity Information	16
EU	17

Be sure to always remove the power supply before connecting or disconnecting the Strato Pi Fan board to Raspberry Pi.

Follow all applicable electrical safety standards, guidelines, specifications and regulations for installation, wiring and operations of Strato Pi Fan.

Carefully and fully read this Strato Pi Fan user guide before installation.

Strato Pi Fan is not authorised for use in safety-critical applications where a failure of the product would reasonably be expected to cause personal injury or death. Safety-critical applications include, without limitation, life support devices and systems, equipment or systems for the operation of nuclear facilities and weapons systems. Strato Pi Fan is neither designed nor intended for use in critical military or aerospace applications or environments and for automotive applications or environment. Customer acknowledges and agrees that any such use of Strato Pi Fan is solely at Customer's risk, and that Customer is solely responsible for compliance with all legal and regulatory requirements in connection with such use.

Sfera Labs S.r.l. may make changes to specifications and product descriptions at any time, without notice. The product information on the web site or materials is subject to change without notice.

Please download and read the Sfera Labs Terms and Conditions document available at:

<http://www.sferalabs.cc>

Strato and Sfera Labs are trademarks of Sfera Labs S.r.l. Other brands and names may be claimed as the property of others.

Copyright © 2021 Sfera Labs S.r.l. All rights reserved.

Safety information

Carefully and fully read this user guide before installation and retain it for future reference.

Qualified personnel

The product described in this manual must be operated only by personnel qualified for the specific task and installation environment, in accordance with all relevant documentation and safety instructions. A qualified person should be capable of fully identifying all installation and operation risks and avoid potential hazards when working with this product.

Hazard levels

This manual contains information you must observe to ensure your personal safety and prevent damage to property. Safety information in this manual are highlighted by the safety symbols below, graded according to the degree of danger.



Indicates a hazardous situation which, if not avoided, **will** result in death or serious personal injury.



Indicates a hazardous situation which, if not avoided, **may** result in death or serious personal injury.



Indicates a hazardous situation which, if not avoided, can result in minor or moderate personal injury.



Indicates a situation which, if not avoided, can result in damage of property.

Safety instructions

General safety instructions

Protect the unit against moisture, dirt and any kind of damage during transport, storage and operation. Do not operate the unit outside the specified technical data.

Never open the housing. If not otherwise specified, install in closed housing (e.g. distribution cabinet). Earth the unit at the terminals provided, if existing, for this purpose. Do not obstruct cooling of the unit. Keep out of the reach of children.



Life threatening voltages are present within and around an open control cabinet.

When installing this product in a control cabinet or any other areas where dangerous voltages are present, always switch off the power supply to the cabinet or equipment.



Risk of fire if not installed and operated properly.

Follow all applicable electrical safety standards, guidelines, specifications and regulations for installation, wiring and operations of this product.

The Raspberry Pi board could generate a substantial amount of heat when the software forces the CPU and/or GPU to operate at high load levels. Ensure that the product is properly installed and ventilated to prevent overheating.



The connection of expansion devices to this product may damage the product and other connected systems, and may violate safety rules and regulations regarding radio interference and electromagnetic compatibility.

Use only appropriate tools when installing this product. Using excessive force with tools may damage the product, alter its characteristics or degrade its safety.

Introduction

Strato Pi Fan is an expansion board that enhances the Raspberry Pi Model B version 2, 3 and 4 with a high speed temperature controlled fan, expanding the operating temperature range of the Raspberry Pi and reducing or delaying CPU throttling under heavy CPU load.

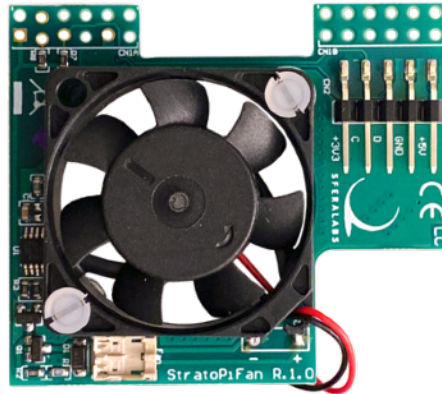

Features

- ✓ high performance 9100 RPM, 4.9 CFM (Cubic Feet per Minute) fan
- ✓ on-board LM75ADP temperature sensor and fan controller, with I²C interface
- ✓ slim design pass-through installation on the GPIO connector, compatible with many third party expansion boards
- ✓ I²C pin-headers to wire additional I²C devices.

Usage and connections

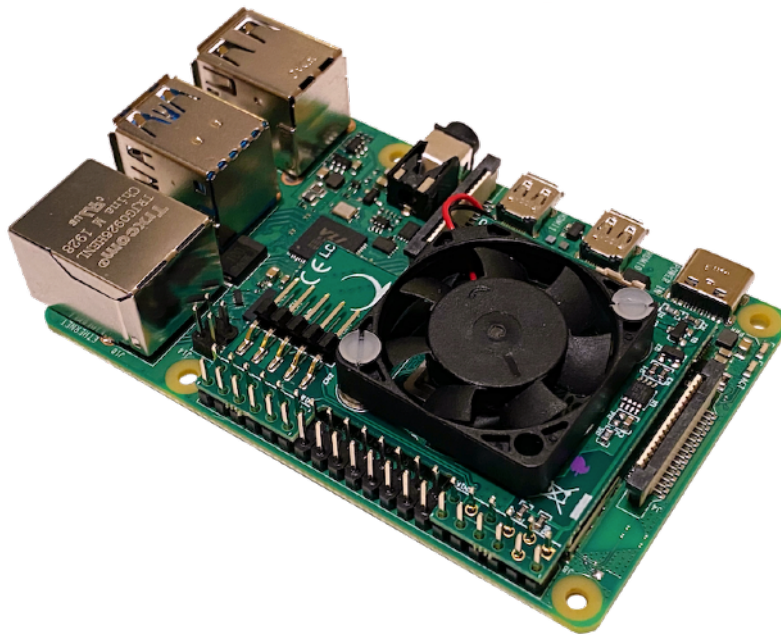

STRATO PI FAN BOARD INSTALLED ON THE RASPBERRY PI

Hardware Installation

The Strato Pi Fan board is supplied with all connectors pre-installed. No soldering is required. You should connect Strato Pi to Raspberry Pi aligning the GPIO connector. Ensure that no conductive part of one board touches any part of the other board.

The circuit board holes used for power supply and the I²C bus are slightly offset to improve the electrical connection to the GPIO header pins. Pushing the Strato Pi Fan board down will slightly tilt the header pins. If you need to fit another expansion board on top, with a female GPIO connector, it is recommended to insert the Strato Pi Fan board only about halfway down, then connect the female GPIO connector, and finally push both down.

The Strato Pi Fan printed circuit board thickness is just 1.0 mm, so any expansion board will be at most 1.0 mm above its normal position.

NOTICE

The GPIO connector of the Strato Pi Fan board must be perfectly aligned to the Raspberry Pi's GPIO pins. Turning on the Raspberry Pi and/or the Strato Pi Fan board with the GPIO not correctly connected will damage both the Raspberry Pi and Strato Pi Fan board.

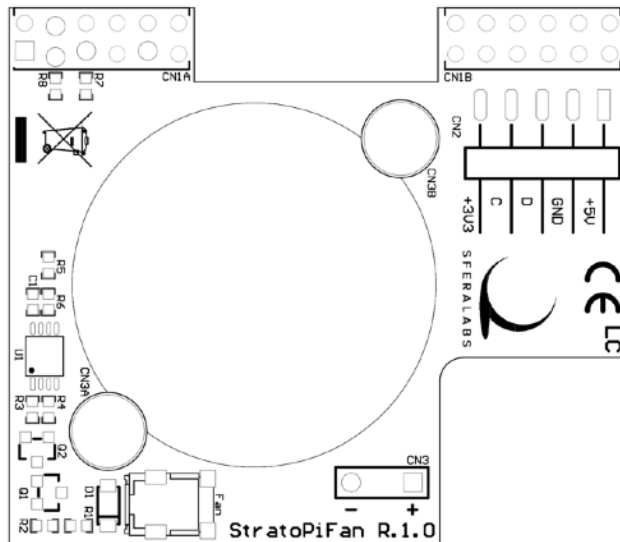

THE STRATO PI FAN CIRCUIT BOARD

Device identification

The device can be identified with the information provided in the rating and identification plate, placed on the device packaging.



Strato Pi Fan
S/N: SPBF10X – 19500063



MADE IN ITALY



P/N: SPBF10X
LOT: 210701
DATE: 2107
COO: IT
QTY: 1

Sfera Labs S.r.l.
Str 4 Pal Q6 – 20089
Rozzano (MI) Italy
www.sferalabs.cc

EXAMPLE RATING AND IDENTIFICATION PLATE

Power supply

Strato Pi Fan receives power from the Raspberry Pi GPIO connector. Both 3.3V and 5V are required to operate. The 3.3V rail supplies the temperature sensor and fan controller, while 5V is used to power the fan. The 3.3V and 5V lines are also available on the on-board 5 pin I²C header connector.

GPIO pins

Strato Pi Fan uses the following Raspberry Pi's GPIO pins:

Pin #	Function	Description
1	3V3	3.3V line
4	5V	5.0V line
9	GND	GND line
3	GPIO2/SDA	I ² C SDA line
5	GPIO3/SCL	I ² C SCL line

I²C header

An on-board 5 pin 2.54mm header (CN2) carries the following lines, that can be conveniently used when the main GPIO connector is used to connect other expansion boards:

1. **+5V** - 5.0V line
2. **GND** - GND line
3. **D** - I²C SDA line
4. **C** - I²C SCL line
5. **+3V3** - 3.3V line

NOTICE

These lines are directly connected to the corresponding lines on the Raspberry Pi's GPIO connector, without additional protection, and have the same electrical limitations and specifications. Damage to the Raspberry Pi, the Strato Pi Fan and any other connected device will occur if used outside the specifications limits.

Software installation and configuration

Strato Pi Fan can be used with any operating system, programming language or framework compatible with Raspberry Pi.

All the features are controlled via standard I²C communication on the primary I²C bus (i2c-1).

Our Strato Pi Fan kernel module for the Raspberry Pi OS (formerly Raspbian) provides for easy usage via sysfs files, without the need to implement the underlying I²C protocol.

For usage on other operating systems or to avoid the kernel module installation, refer to the "I²C Control" paragraph in the next chapter.

Raspberry Pi OS kernel module

The Strato Pi Fan kernel module can be used to easily access Strato Pi Fan's features via sysfs file system.

Refer to the following instructions to download and install the module or go to:

<https://github.com/sfera-labs/strato-pi-fan-kernel-module>

for updated instructions and further details and examples.

Download and install:

```
$ sudo apt install git raspberrypi-kernel-headers
$ git clone --depth 1 https://github.com/sfera-labs/strato-pi-fan-kernel-module.git
$ cd strato-pi-fan-kernel-module
$ make
$ sudo make install
$ dtc -@ -Hepapr -I dts -O dtb -o stratopifan.dtbo stratopifan.dts
$ sudo cp stratopifan.dtbo /boot/overlays/
```

Add the following line to /boot/config.txt:

```
dtoverlay=stratopifan
```

Optionally, to be able to use the sysfs files not as super user, create a new group "stratopifan" and set it as the module owner group by adding an udev rule:

```
$ sudo groupadd stratopifan
$ sudo cp 99-stratopifan.rules /etc/udev/rules.d/
```

and add your user to the group, e.g., for user "pi":

```
$ sudo usermod -a -G stratopifan pi
```

Reboot:

```
$ sudo reboot
```

After installation, you'll find the directory /sys/class/stratopifan/ which gives you access to Strato Pi Fan's functionalities.

Refer to the next chapter for usage details.

Using Strato Pi Fan

The fan is directly controlled by the on-board temperature sensor. It is activated when the measured temperature exceeds the configured TEMP_ON threshold value and, once active, it is deactivated when the temperature goes below the configured TEMP_OFF threshold value.

On Raspberry Pi OS, after installing the Strato Pi Fan kernel module, you can monitor the system temperature by reading the file `/sys/class/stratopifan/sys_temp/temp`.

To set the TEMP_ON and TEMP_OFF thresholds write respectively to `/sys/class/stratopifan/fan/temp_on` and `/sys/class/stratopifan/fan/temp_off`.

All temperature values are expressed in °C/100, i.e. a value of 4050 corresponds to 40.5°C. Thresholds values range from -128°C to 127.5°C with a 0.5°C resolution.

If you want to manually activate the fan, simply set the TEMP_ON threshold to a value lower than the current temperature.

The TEMP_OFF value should always be lower than TEMP_ON.

For usage examples go to:

<https://github.com/sfera-labs/strato-pi-fan-kernel-module>

I²C Control

Strato Pi Fan is based on the LM75ADP temperature sensor which monitors the temperature and activates the fan based on configured thresholds.

The sensor can be directly accessed on the Raspberry Pi's primary I²C bus (i2c-1) at address 0x48.

The relevant registers used for temperature reading and thresholds configuration are described below.

Refer to the LM75ADP data-sheet for further details.

TEMPERATURE

ADDR	BYTE 1								BYTE 0								R/W	
	15	14	13	12	11	10	9	8	7	6	5	4	3	2	1	0		
0	TEMP																	R

Register 0

Bit 15-5 **TEMP**: Measured temperature.
 11-bit 2's complement signed value with 0.125°C resolution.

THRESHOLDS

ADDR	BYTE 1								BYTE 0								R/W	
	15	14	13	12	11	10	9	8	7	6	5	4	3	2	1	0		
2	TEMP_OFF																	R/W
3	TEMP_ON																	R/W

Register 2

Bit 15-7 **TEMP_OFF**: Temperature threshold for deactivating the fan.
11-bit 2's complement signed value with 0.5 °C resolution.

Default value 0x4B00 (75°C).

Register 3

Bit 15-7 **TEMP_ON**: Temperature threshold for activating the fan.
11-bit 2's complement signed value with 0.5 °C resolution.

Default value 0x5000 (80°C).

Thermal considerations

The thermal effects of the Strato Pi Fan are affected by several factors, including the external environment conditions, the enclosure, and the CPU and electrical loads.

In general terms, the fan will significantly increase the airflow inside the enclosure, and improve heat transfer away from the CPU and the other nearby components on the Raspberry Pi board.

The CPU will run cooler than without Strato Pi Fan, and it will take longer and higher loads to reach its throttling limits.

Under ideal conditions, Strato Pi Fan may reduce both the CPU temperature and the average air temperature inside a relatively small enclosure by up to 15 °C.

The following charts show measured temperatures in a standard 4 units DIN-rail enclosure, with Strato Pi Fan fitted between the Raspberry Pi 4B and a Iono Pi board. This configuration also takes into account the heat generated by the Iono Pi board voltage regulator. The unit under test was installed in a small DIN-rail cabinet.

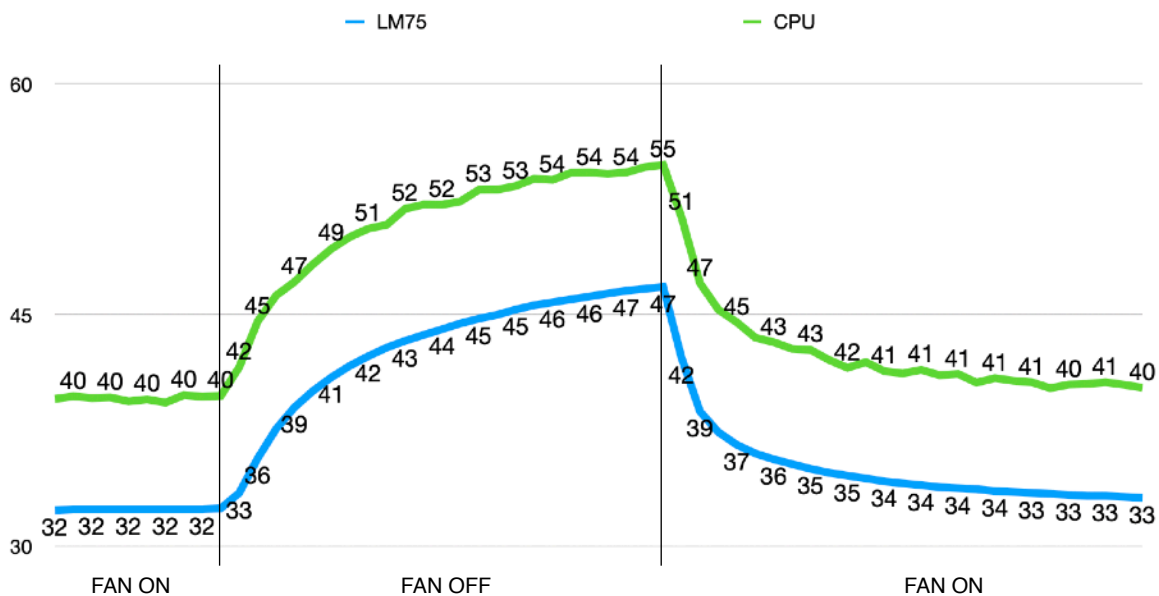

DIN-RAIL ENCLOSURE - 20C AMBIENT TEMPERATURE - LOW CPU LOAD

With an air temperature around the enclosure of 20 °C, the air temperature inside the enclosure, as measured by the LM75 sensor on the Strato Pi Fan board, would be around 45 to 50 °C with a low CPU load. With the fan running, this temperature drops to approximately 33 °C. The CPU temperature, measured by its internal sensor, also drops by 15 °C, and remains stable at 40 °C.

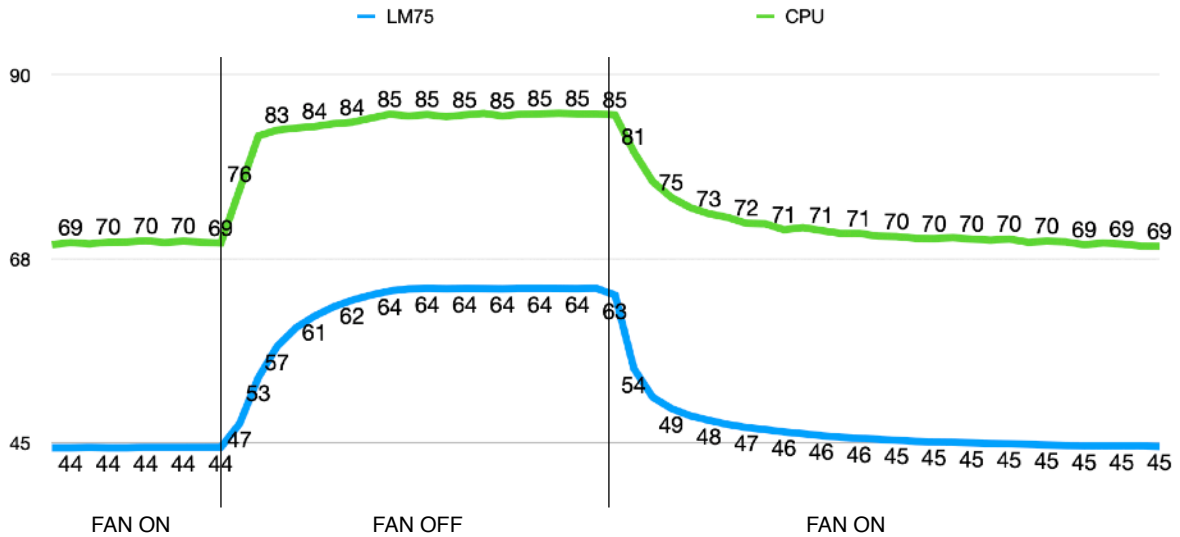

DIN-RAIL ENCLOSURE - 20C AMBIENT TEMPERATURE - 100% CPU LOAD

Under the same external conditions, but with the CPU constantly at 100% load (on all cores), the beneficial effect of Strato Pi Fan are even more significant. With the fan running, the CPU never comes close to the throttling temperature, operating at approximately 70 °C instead of 85 °C.

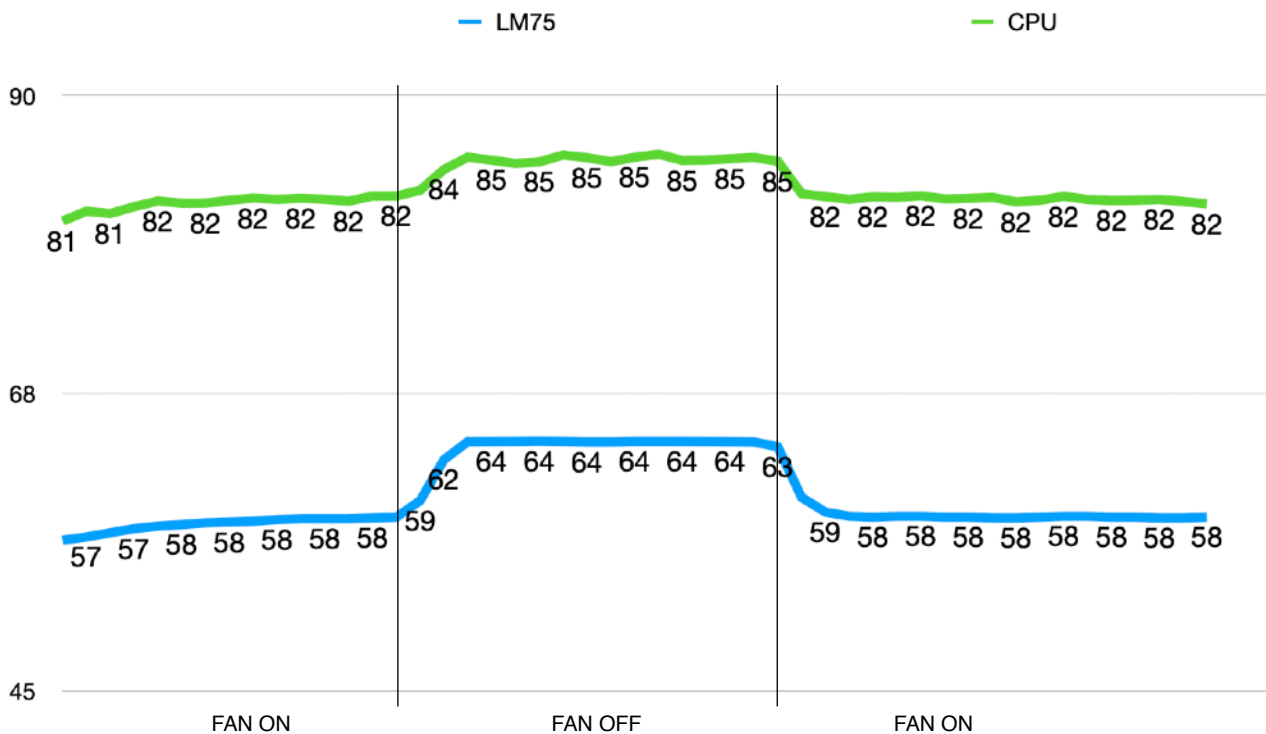

DIN-RAIL ENCLOSURE - 45C AMBIENT TEMPERATURE - 100% CPU LOAD

At a much higher, 45 °C external temperature, and with the CPU constantly at 100% load, Strato Pi Fan is still able to keep the CPU temperature a few degrees below the throttling limit, and reduce the enclosure internal air temperature by several degrees.

Circuit schematic

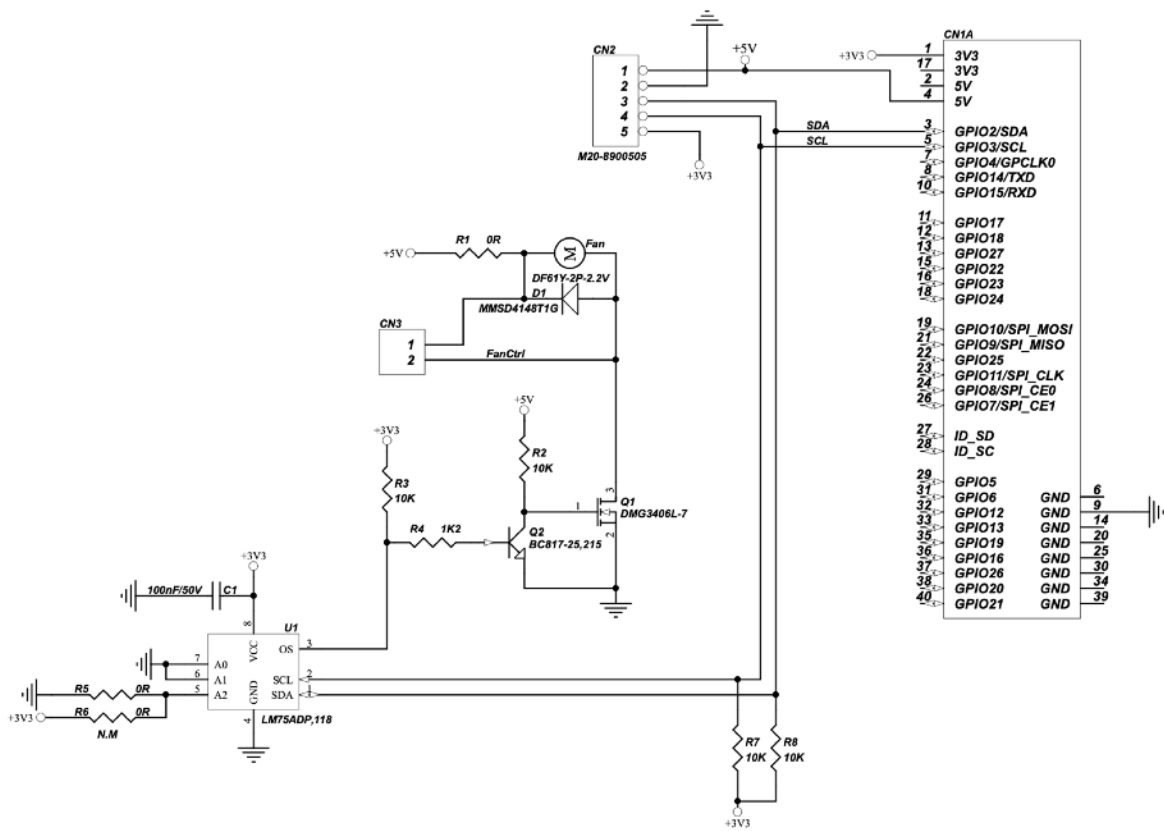

STRATO PI FAN CIRCUIT SCHEMATIC

Technical specifications

Power supply	3.3 V, 5 mA 5.0 V, 130 mA max. (fan on)
Fan speed	9100 RPM
Fan airflow	4.9 CFM
Fan noise	23.6 dBA
Temperature accuracy	±2 °C
Dimensions (W x D x H)	50 x 45 x 10 mm
Operating temperature	-20...+70 °C
Storage temperature	-30...+70 °C
Relative humidity	5% to 90% noncondensing
Weight	10 g

Disposal

Waste Electrical & Electronic Equipment



(Applicable in the European Union and other European countries with separate collection systems). This marking on the product, accessories or literature indicates that the product should not be disposed of with other household waste at the end of their working life. To prevent possible harm to the environment or human health from uncontrolled waste disposal, separate these items from other types of waste and recycle them responsibly to promote the sustainable reuse of material resources. Household users

should contact either the retailer where they purchased this product, or their local government office, for details of where and how they can take these items for environmentally safe recycling. This product and its electronic accessories should not be mixed with other commercial wastes for disposal.

Installation and use restrictions

Standards and regulations

The design and the setting up of electrical systems must be performed according to the relevant standards, guidelines, specifications and regulations of the relevant country. The installation, configuration and programming of the devices must be carried out by trained personnel.

The installation and wiring of connected devices must be performed according to the recommendations of the manufacturers (reported on the specific data sheet of the product) and according to the applicable standards.

All the relevant safety regulations, e.g. accident prevention regulations, law on technical work equipment, must also be observed.

Safety instructions

Carefully read the safety information section at the beginning of this document.

Set-up

For the first installation of the device proceed according to the following procedure:

- ✓ make sure all power supplies are disconnected
- ✓ install and wire the device according to the schematic diagrams on the specific product user guide
- ✓ after completing the previous steps, switch on the power supply and other related circuits.

Conformity Information

The declaration of conformity is available at: <https://www.sferalabs.cc/>

EU

This device complies with the essential requirements of the following directives and harmonised standards:

- ✓ 2011/65/EU and 2015/863/EU - Restriction of the use of certain hazardous substances in electrical and electronic equipment (RoHS).

Mouser Electronics

Authorized Distributor

Click to View Pricing, Inventory, Delivery & Lifecycle Information:

[Sfera Labs:](#)

[SPBF10X](#)