

NO: FJOS1607105客 户: **F14217AA0216**

CUSTOMER _____

承 认 书

SPECIFICATION FOR APPROVAL

客户料号:

CUSTOMER PART NO _____

福佳型号: **FJ-SW0504000N(528 活动脚)**

FUJIA PART NO _____

品名规格: **5V 4000mA 开关电源**

DESCRIPTION _____

编制日期: **2016-07-14(过六级, 过 REACH, 过 ROHS)**

DATE _____



制造商 MANUFACTURE			客户承认 CUSTOMER APPROVAL	
设计 DESIGN	审核 CHECKED	批准 APPROVED	请客户确认回传我司存档, 谢谢	
陆彩燕				

深圳福佳电器有限公司

SHENZHEN FU JIA APPLIANCE CO., LTD.

地址: 深圳宝安区福永镇新和村蚝业路旭竟昌科技工业园 B1 栋福佳大厦

电话: 0755-33663999 传真: 0755- 33668366 邮编: 518103



目录

- 1 概述/SCOPE**
- 2 输入特性/INPUT CHARACTERISTICS**
- 3 输出特性/OUTPUT CHARACTERISTICS**
- 4 保护功能/ PROTECTION FUNCTION**
- 5 环境要求/ENVIRONMENTAL REQUIREMENTS**
- 6 机械特性 MECHANICAL CHARACTERISTICS**
- 7 安全标准 /SAFETY**
- 8.EMC 标准/ EMC STANDARD**
- 9 体积/VOLUME**
- 10 重量/WEIGHT**
- 11 外观图/OUTLOOK DRAWING**
- 12 铭牌 /LABEL**
- 13 包装图示/PACKING**
- 14 样品测试报告 / SAMPLES TEST REPORT**

1 概述 /SCOPE

本规格书适合于 [FJ-SW0504000N](#) 认证型号的开关电源。

The purpose of the document is to specify the functional requirements of [FJ-SW0504000N](#) switching power supply.

2. 输入特性/ INPUT CHARACTERISTICS:

2.1 输入电压/ Input Voltage

额定输入电压/ Rated Input Voltage: 100-240Vac

可变输入电压/Variable input voltage : 90V—264Vac

2.2 输入电流/Input Current:

当输入额定电压带额定负载时，最大的输入交流电流 [1.5A](#)

[1.5A](#) max when input rated voltage and output rated load.

2.3 输入频率/ Input Frequency

额定频率/Rate Frequency:50/60Hz

调整频率/ Variation Frequency: 47-63Hz

2.4 浪涌电流/In-rush Current:

当输出为额定负载，环境温度为 25℃,输入 240Vac 冷启动时的最大浪涌电流为 60A。

60 A mps Max Cold start at 240Vac input ,with rated load and 25℃ ambient.

2.5 AC 漏电流/ AC leakage Current:

当输入电压 240Vac 时，最大的漏电流为 0.25mA

0.25mA Max .At 240Vac input

3. 输出特性/OUTPUT CHARACTERISTICS:

3.1 额定输出功率/Rated Output Power [20W](#)

3.2 负载特性/调整率 (Combined Load/line Regulation)

电压	最小负载	最大负载	负载调整	空载输出电压
Voltage	Min. Load	Max Load	Load Regulation	Unload output voltage
+5V	0A	4.0A	4.75V-5.45V	5.0V-5.45V

3.3 效率/Efficiency:

6 级平均工作效率 $\geq 83.08\%$

当输入 115VAC 时, 平均效率 $\geq 83.08\%$ 。是输出额定负载的 25%,50%,75%,100%4 种情况下平均效率,
115VAC input, the average efficiency $\geq 83.08\%$ 。 output rated load is 25%,50%,75%,100% 4 situations of average efficiency

当输入 230VAC 时, 平均效率 $\geq 83.08\%$ 。是输出额定负载的 25%,50%,75%,100%4 种情况下平均效率,
230VAC input, the average efficiency $\geq 83.08\%$ 。 output rated load is 25%,50%,75%,100% 4 situations of average efficiency

3.4 空载待机功率/Unload standby Power: **0.1W Max**

3.5 纹波和噪音/ Ripple And Noise

纹波与噪声: 测量时示波器选用 20MHz 带宽限制,输出端要并联一颗 0.1uF 的陶瓷电容和一颗 47uF 的电解电容。(在额定输入及输出的条件下检测)

Ripple & Noise: Measurement is done by 20MHz bandwidth oscilloscope and the output paralleled a 0.1uF ceramic capacitor and a 47uF electrolysis capacitor. (test under the condition of rated input and rated output)

电压	电流	最大纹波最大噪音
Voltage	current	Ripple And Noise(Max)
+5V	<u>4000mA</u>	100m Vp-p

3.6 启动延迟时间/ Turn On Delay Time:

当输入 100Vac 和输出最大负载时, 最大启动时间为 3S
3 second Max .At 100Vac input and output Max. Load

3.7 上升时间/ Rise Time:

当输入 100Vac 和输出最大负载时最大时间为 100ms
100ms Max. At 100Vac input and output Max. Load

3.8 保持时间/Hold Up Time :

当输入 100Vac 和输出最大负载时, 最小保持时间为 5ms
5ms Min.at100Vac input and output Max .Load.

3.9 过充/ Overshoot:

在电源开启或关闭的时候, 最大 10%
10% Max. When power supply on or turn off.

4. 保护功能/ PROTECTION FUNCTION:

4.1 短路电路保护/Short circuit protection:

电源供给器在短路解除后能正常恢复工作。

The Power Supply will be auto recovered when short circuit faults remove.

4.2 过流保护/ Over current Protection:

过流点限制/Over Current Point Limited:是额定电流的 120-200%(input:100-240Vac)

当过电流时,输出将进入打嗝模式,当过流情况解除后,产品将会自动恢复正常

The output shall hiccup when the over currents applied to the output t rail, and shall be self-recovery when the fault condition is removed

5. 环境要求/ENVIRONMENTAL REQUIREMENTS

5.1 工作温度/Operating Temperature

0°C -- +40°C,满载, 正常工作。

0°C to +40°C ,Full Load, Normal Operation.

5.2 储存温度/Storage temperature

带外壳 :-10°C -- +55°C

With enclosure:-10°C to+55°C

5.3 工作湿度/Relative Humidity:

5%(0°C)~90%(40°C) ,72 小时, 满载, 正常工作。

5%(0°C)~90%(40°C) 72h Full Load , Normal operating.

5.4 振动/ Vibration:

5.4.1 测试标准: 国际电工电子委员会

Operating: IEC 721-3-3 3M3

5~9Hz,A=1.5mm

加速度 (9~200Hz,Acceleration 5m/s)

5.4.2. 运输 (Transportation) :

IEC 721-3-2 2M2

5~9Hz, A=3.5mm

9~200Hz ,加速度 Acceleration=5 m/s²

200~500Hz ,加速度 acceleration=15 m/s²

5.4.3. 轴向振动/ Axes,10 cycles per axis :

在测试过程中不能出现永久性损坏.

No permanent damage occur during testing.

在电源开启和关闭后, 样机能够恢复到最初条件。

The product has to restore to its original situation after power off/on

6. 机械特性/ MECHANICAL CHARACTERISTICS

6.1 跌落实验/ Dropping Testing

产品从一米高处跌落到木板上无损伤。

The product to be dropped from 1 meter height to a concrete floor no breakage.

6.2 摇摆实验/Cable Flexing Testing

DC 引线吊重 200 克, 摇摆角 60 度, 最少能承受 2000 次, 弯曲速度每分 40 次, 不会出现损伤。

The DC cord shall with weight of 200g,it swings at angle 60 deg ,2000cycle

Time min Bending speed: 40cycle per minute shall to be no breakage to the code

7. 安全标准 SAFETY STANDARD

7.1 安全:符合标准 IEC60950,EN60950, UL60950,GB4943。

Safety Accord with IEC60950, EN60950, UL60950,GB4943.

注: 相应的 AC 插脚对应相应国家的标准, 如 CE 即对应为 EN60950,3000Vac。

Note :AC pins correspondding corresponding corponding to national standards,such as the CE that corresponds to EN60950 ;3000Vac

7.2 高压/ DIELECTRIC STRENGTH Hi-Pot

初级对次级/ Primary to secondary, 3000Vac/5mA/5s.

7.3 绝缘阻抗/ Insulation resistance:

初级对次级/ Primary to secondary :10M Ω Min at 500V DC

8. EMC 标准/EMC STANDARD

EMC---EN55022/EN55024/GB9254-1998 (CISPR 22)

9. 体积/VOLUME: L \times W \times H

长 103.45mm \times 宽 48.45mm \times 高 48mm

10. 重量/ Weight: 183g \pm 20g

11 外观图/OUTLOOK DRAWING (公差/Common difference: +/-0.5mm)

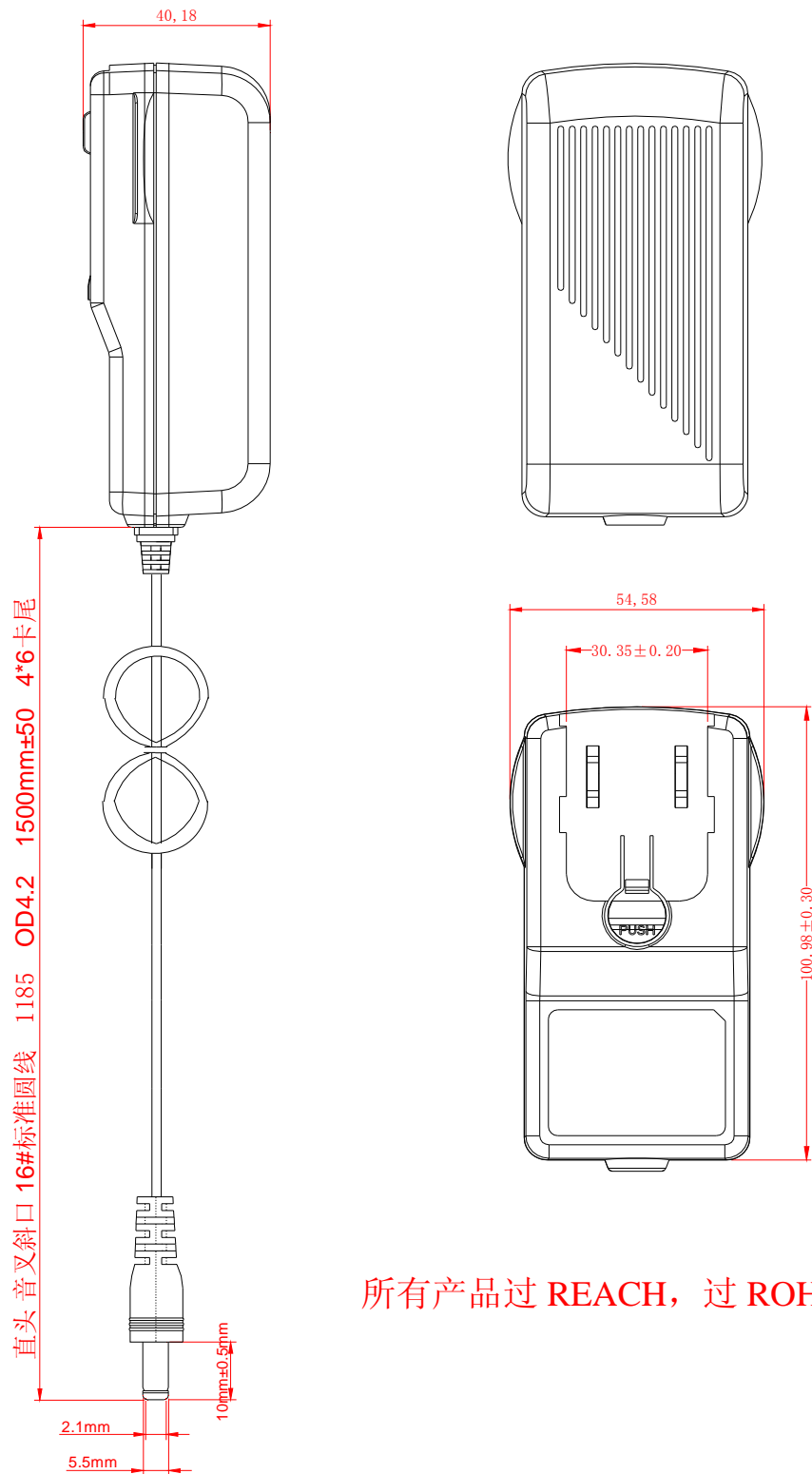

所有产品过 REACH, 过 ROHS

XR-312UL头

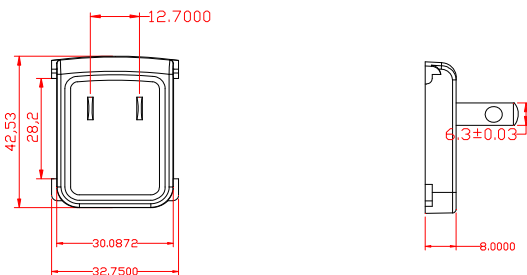

XR-312SAA头

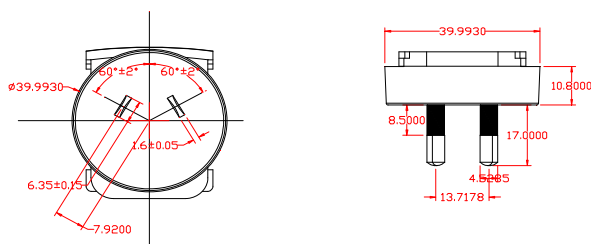

XR-312CE头

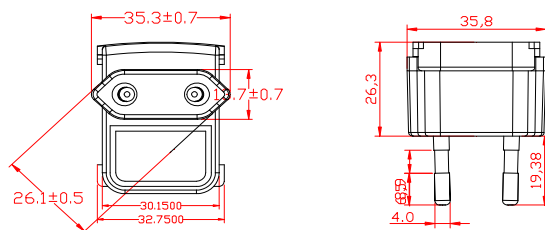

XR-312BS头

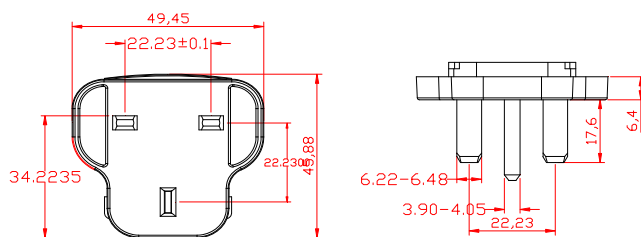

XR-312 CCC头

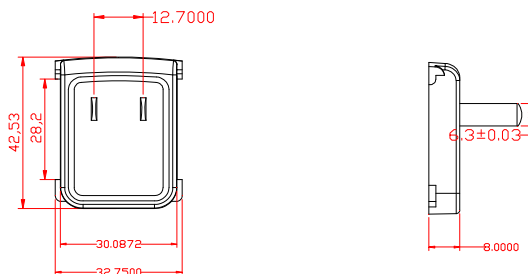

所有产品过 REACH, 过 ROHS

12. 铭牌/LABEL:

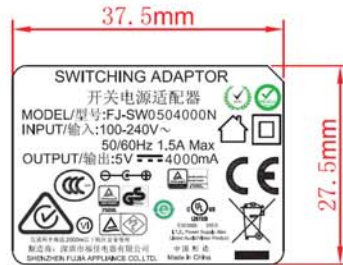

比例/Scale: 1:1

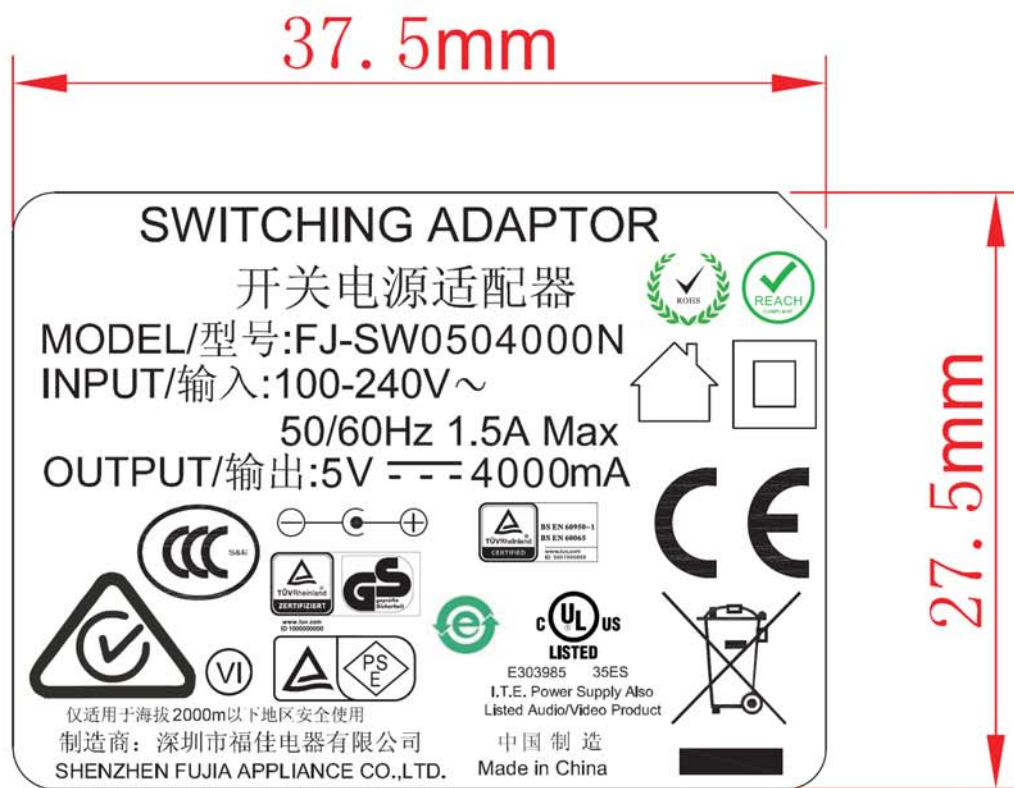

比例/Scale: 3:1

备注/Note:

1. 材料/Material : PVC 环保/ ROHS/REACH.
2. 印刷/Printing : 黑底白字/ black ground White character
3. 尺寸/Size:(W)37.5+/-0.2mm(H)27.5+/-0.2mm
4. 厚度/Thickness:0.15mm
5. 过REACH, 过ROHS

13 包装图示 PACKING

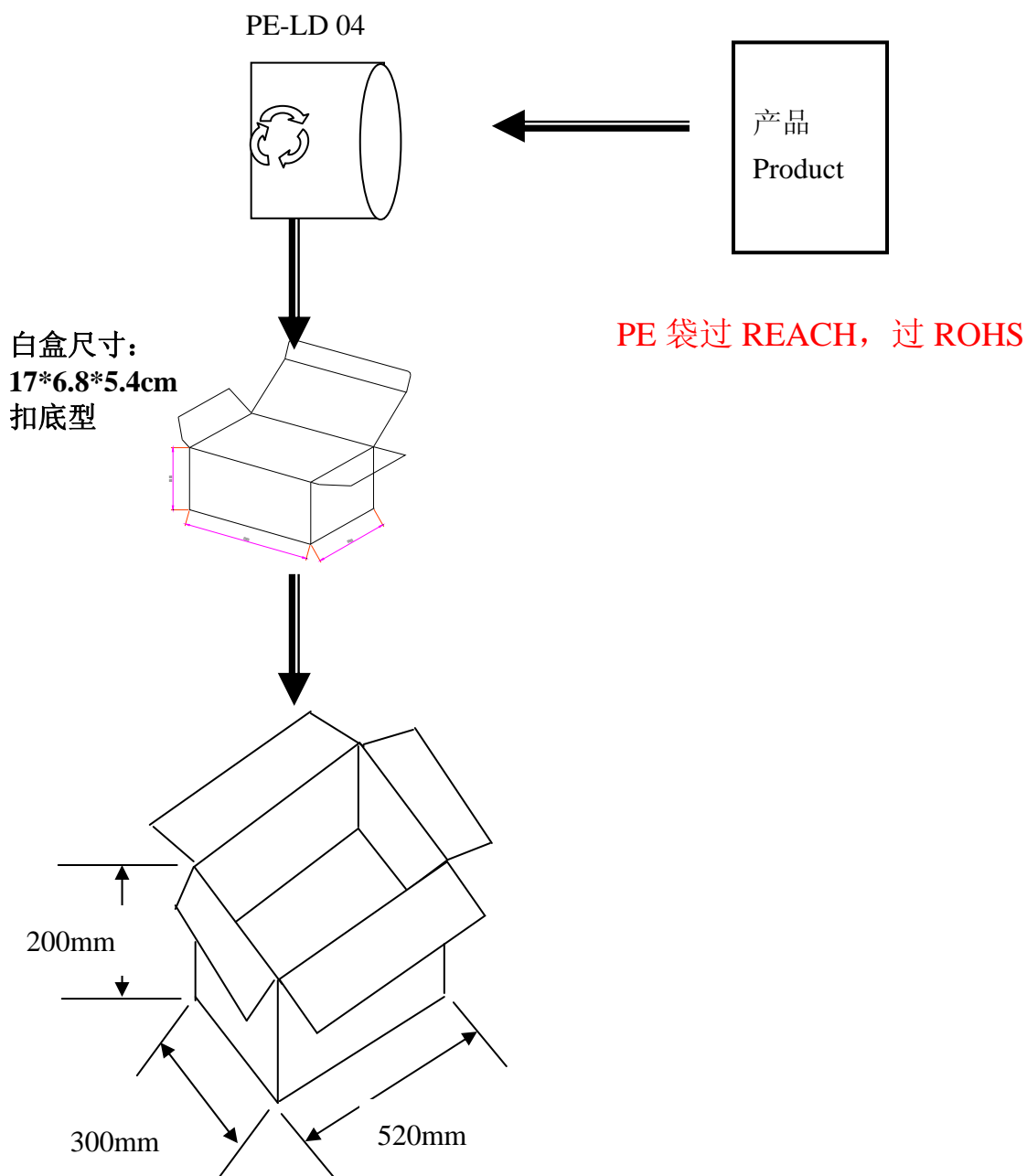

备注/NOTE:

1. 每箱装 36 个，分 3 层，材质 K=K
36PCS Per carton, Divided into 3 floor.
Material K=K
2. PE 袋尺寸：205X140MM 带环保标志。
PE bag size: 205X140MM , With the
environmental protection symbol.

1. 客户专门指定包装。
2. 要印外箱唛头，印 2 面，要印四个标志，外箱上要编箱号，（图 1，供参考）

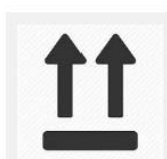

ITEM: PSU5V4A1500M5W-VI

QTY: 36 PCS

N.W.: KG (请生产时用大头笔填写)

G.W.: KG (请生产时用大头笔填写)

P/O: PON1600066 (业务提供: 随生产订单变化而变化)

Carton: (比如1/28 表示第一箱, 如此类推, 请生产时用大头笔填写)

MEAS: 52*30*20CM

Made in China

3. 包装密封，纸箱要用 K=K 材质，不能打钉子的纸箱如图。
can be stacked perfectly.

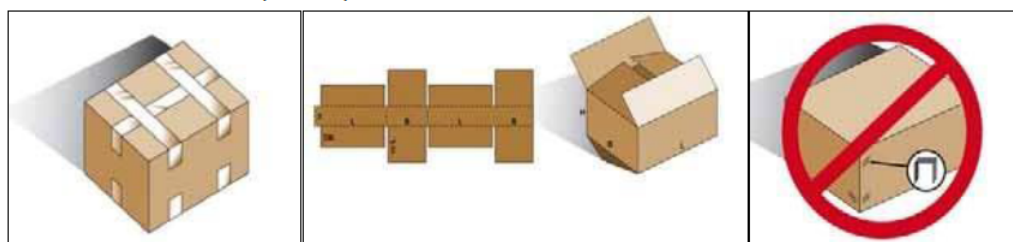

4. 要用纸卡板包装，长宽 1.8*2 米 货物总高度不能超过 1.6M 如图



14 样品测试报告SAMPLES TEST REPORT

客户 Customer	F14217AA0216	客户编号 Customer No	FJOS1607105	室温 Ambient temp	25℃
产品型号 Model NO	528	产品编号 Part No		日期 Date	7月14日
输入电压/频率 Input volt/Freq	100-240Vac 50/60HZ	输出电压/电流 Output volt/Amp	5V 4A		

测试内容 Test content		1#样机/Sample NO:		2#样机/Sample NO:		判定 judge PASS or NG	
NO	测试项目 Test Item	测试标准 spec	100Vac	230Vac	100Vac		230Vac
1	空载电压 Unload voltage	5.0V-5.45V					
2	空载纹波与噪声 UnLoad ripple&noice	≤100mV P-P					
3	满载电压 Rated Load output Voltage	4.75V-5.45V					
4	满载纹波与噪声 Rated load ripple&noice	≤100mV P-P					
5	额定输入电流 Rated input current	≤1500mA					
6	短路保护 Shortcircuit protection	No damage and auto recovered OK/NG					
7	过流保护 Over current protection	120-200%					
8	介电强度测试 Hi-Pot test	AC3KV 5S	<5mA	泄漏电流/Leakage current (mA) ; 绝缘击穿/insulation breakdown: ■OK □NG			
9	绝缘阻抗测试 Insulation resistance	DC500V 5S	>10MΩ	绝缘阻抗/insulation resistance (MΩ) ; 绝缘击穿/insulation breakdown: ■OK □NG			

输入/Input			输出/Output				能源之星/Energy star		
电压 Voltage	功率 Pin(W)	负载% Load%	电压 Vout(V)	电流 Iout(A)	功率 Watt(W)	效率 EFF(%)	平均效率 average Eff(%)	能效标准 VI SPEC	空载功耗 Standby Power(W)
115Vac		100%						平均效率 AVG EFF ≥83.08%	
		75%							
		50%							
		25%							
230Vac		100%						空载功耗 Standby Power <0.1W	
		75%							
		50%							
		25%							

11	100V/240V输入时满载开关机测试 Turn on/off test when rated load and input 100V/240Vac	10 times							
12	115-240V 满载老化/Rated load burn-in test at 115V-240Vac	≥4 hours							

测试/TESTED BY		核准/CHECKED BY		批准/APPROVAL BY	
--------------	--	---------------	--	----------------	--

Mouser Electronics

Authorized Distributor

Click to View Pricing, Inventory, Delivery & Lifecycle Information:

[AAEON:](#)

[OPT-UP-PSU-003](#)