

AMMBT5551-HF (NPN)

RoHS Device
Halogen Free

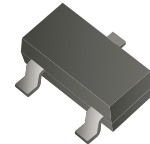

Features

- Epitaxial planar die construction.
- MSL 1.
- AEC-Q101 Qualified.

Mechanical data

- Case: SOT-23, molded plastic.

Circuit Diagram

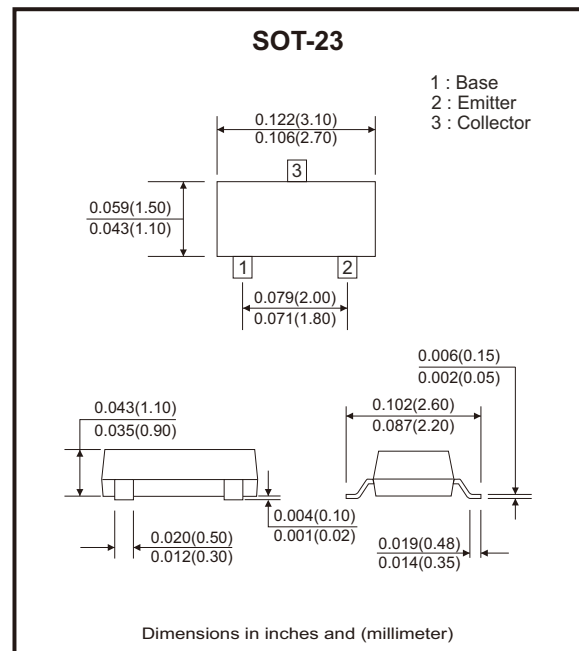
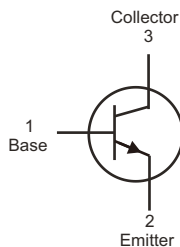

Maximum Ratings (at $T_A=25^\circ\text{C}$ unless otherwise noted)

Parameter	Symbol	Value	Unit
Collector-base voltage	V_{CB0}	180	V
Collector-emitter voltage	V_{CE0}	160	V
Emitter-base voltage	V_{EB0}	6	V
Collector current (DC)	I_C	0.6	A
Collector dissipation	P_C	0.35	W
Thermal resistance, junction to ambient	$R_{\theta JA}$	357	$^\circ\text{C/W}$
Thermal resistance, junction to case	$R_{\theta JC}$	220	$^\circ\text{C/W}$
Junction and storage temperature range	T_J, T_{STG}	-55 ~ +150	$^\circ\text{C}$

Electrical Characteristics (at Ta=25°C unless otherwise noted)

Parameter	Conditions	Symbol	Min	Max	Unit
Collector-base breakdown voltage	$I_C = 100\mu A, I_E = 0$	$V_{(BR)CBO}$	180		V
Collector-emitter breakdown voltage	$I_C = 0.1mA, I_B = 0$	$V_{(BR)CEO}$	160		V
Emitter-base breakdown voltage	$I_E = 10\mu A, I_C = 0$	$V_{(BR)EBO}$	6		V
Collector cut-off current	$I_E = 0, V_{CB} = 120V$	I_{CBO}		50	nA
Emitter cut-off current	$I_C = 0, V_{EB} = 4V$	I_{EBO}		50	nA
DC current gain	$V_{CE} = 5V, I_C = 1mA$	$h_{FE(1)}$	80		
	$V_{CE} = 5V, I_C = 10mA$	$h_{FE(2)}$	100	300	
	$V_{CE} = 5V, I_C = 50mA$	$h_{FE(3)}$	30		
Collector-emitter saturation voltage	$I_C = 10mA, I_B = 1mA$ $I_C = 50mA, I_B = 5mA$	$V_{CE(sat)}$		0.15 0.2	V
Base-emitter saturation voltage	$I_C = 10mA, I_B = 1mA$ $I_C = 50mA, I_B = 5mA$	$V_{BE(sat)}$		1 1	V
Transition frequency	$I_C = 10mA, V_{CB} = 10V, f = 100MHz$	f_T	100	300	MHz
Output capacitance	$I_E = 10mA, V_{CE} = 10V, f = 1MHz$	C_{obo}		6.0	pF

Rating and Characteristic Curves (AMMBT5551-HF)

Fig.1 - Typical Pulsed Current Gain vs Collector Current

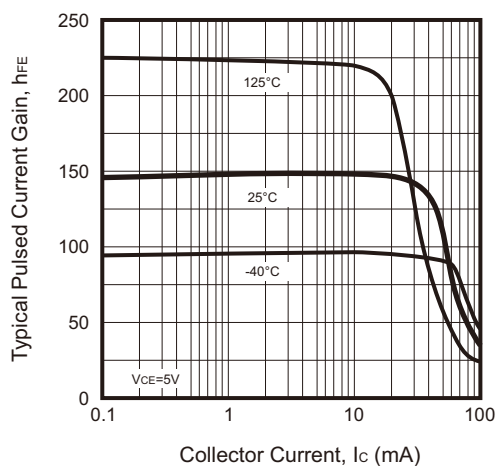
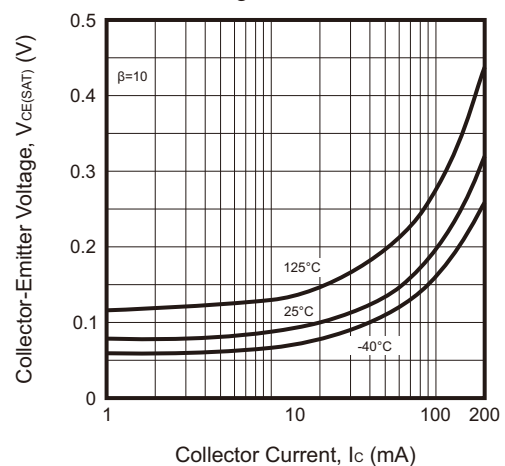

Fig.2 - Collector-Emitter Saturation Voltage vs Collector Current



Rating and Characteristic Curves (AMMBT5551-HF)

Fig.3 - Base-Emitter Saturation Voltage vs Collector Current

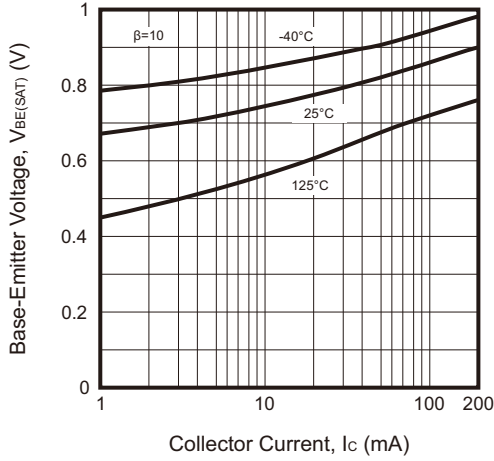

Fig.4 - Base-Emitter On Voltage vs Collector Current

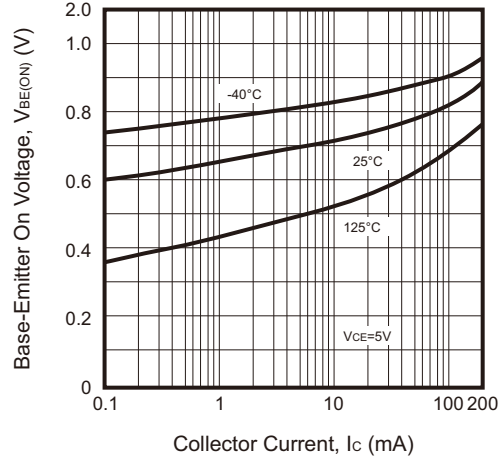

Fig.5 - Collector-Cutoff Current vs Ambient Temperature

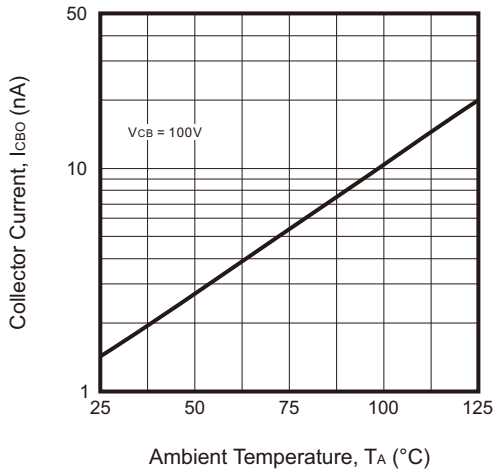

Fig.6 - Collector-Emitter Breakdown Voltage with Resistance Between Emitter-Base

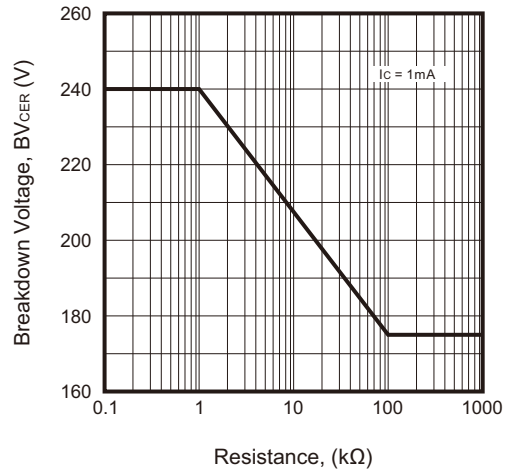

Fig.7 - Input and Output Capacitance vs Reverse Voltage

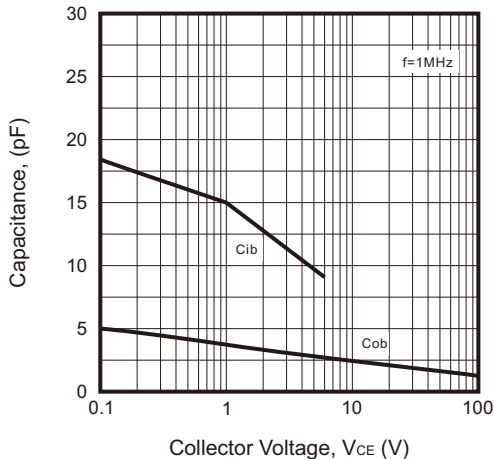
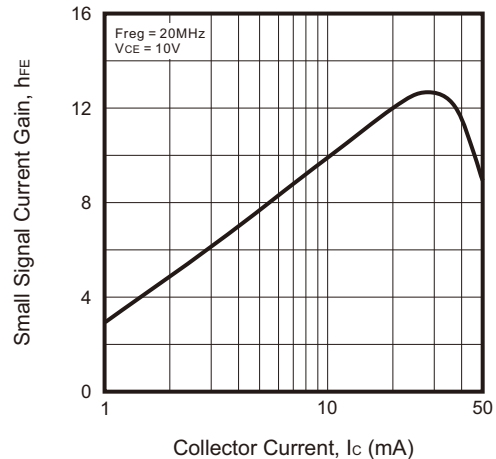
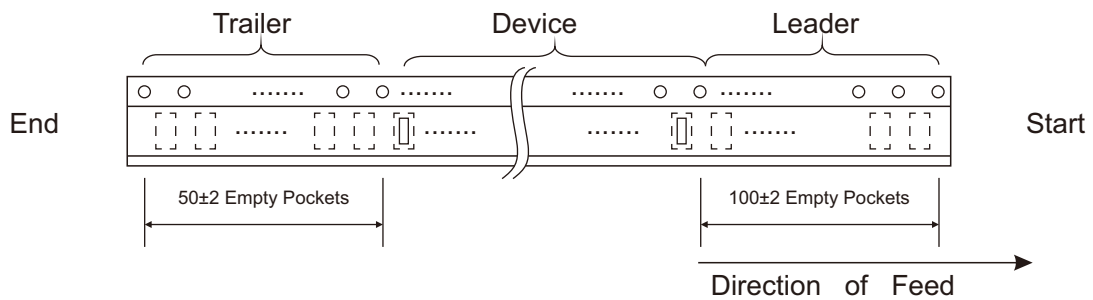
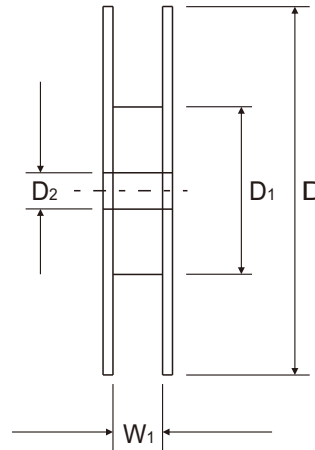
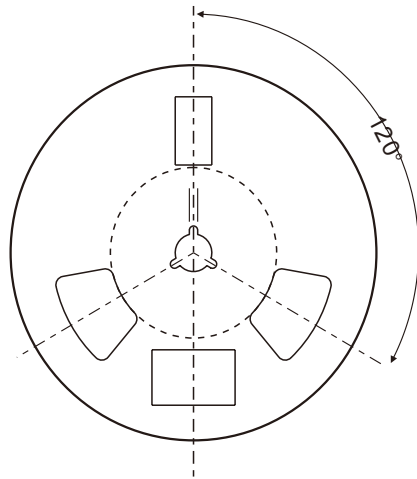
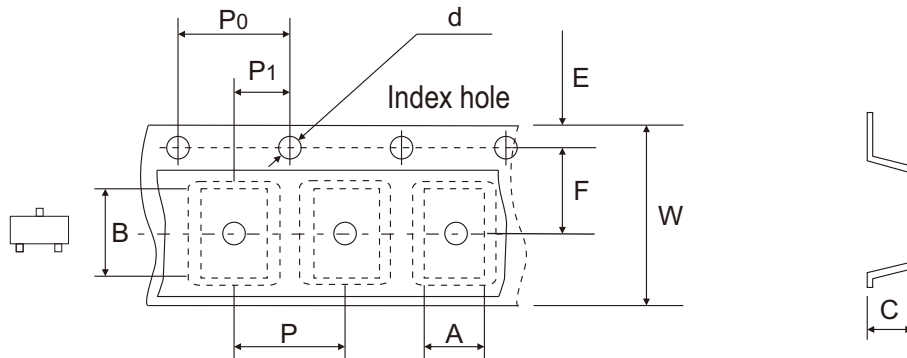

Fig.8 - Small Signal Current Gain vs Collector Current



Company reserves the right to improve product design, functions and reliability without notice.

Reel Taping Specification



SOT-23	SYMBOL	A	B	C	d	D	D1	D2
	(mm)	3.15 ± 0.10	2.77 ± 0.10	1.22 ± 0.10	1.50 ± 0.10	178.00 ± 1.00	54.00 ± 0.50	13.00 ± 0.50
	(inch)	0.124 ± 0.004	0.109 ± 0.004	0.048 ± 0.004	0.059 ± 0.004	7.008 ± 0.039	2.126 ± 0.020	0.512 ± 0.020

SOT-23	SYMBOL	E	F	P	P0	P1	W	W1
	(mm)	1.75 ± 0.10	3.50 ± 0.05	4.00 ± 0.10	4.00 ± 0.10	2.00 ± 0.05	$8.00 + 0.30 - 0.10$	9.50 ± 1.00
	(inch)	0.069 ± 0.004	0.138 ± 0.002	0.157 ± 0.004	0.157 ± 0.004	0.079 ± 0.002	$0.315 + 0.012 - 0.004$	0.374 ± 0.039

Company reserves the right to improve product design, functions and reliability without notice.

REV:A

Marking Code

Part Number	Marking Code
AMMBT5551-HF	G1



Suggested PAD Layout

SIZE	SOT-23	
	(mm)	(inch)
A	0.90	0.035
B	0.80	0.031
C	0.95	0.037
D	2.00	0.079
E	2.90	0.114

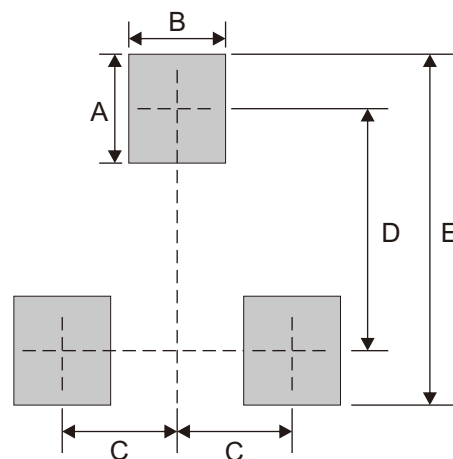

Note: 1. The pad layout is for reference purposes only.

Standard Packaging

Case Type	REEL PACK	
	REEL (pcs)	Reel Size (inch)
SOT-23	3,000	7

Mouser Electronics

Authorized Distributor

Click to View Pricing, Inventory, Delivery & Lifecycle Information:

[Comchip Technology:](#)

[AMMBT5551-HF](#)