

IPS-3082GC-24V



O-Ring WEB-site

Industrial 10-port managed PoE Ethernet switch with 8x10/100Base-T(X) P.S.E. and 2xGigabit combo ports, SFP socket, 24VDC power inputs

Features

- World's fastest Redundant Ethernet Ring: O-Ring (recovery time < 10/30ms over 250 units of connection)
- O-Chain allow multiple redundant network rings
- Support standard IEC 62439-2 MRP^{*NOTE} (Media Redundancy Protocol) function
- MSTP/RSTP/STP (IEEE 802.1s/w/D)
- 8 ports P.S.E. fully compliant with IEEE802.3af standard, provide up to 15.4 Watts per port
- Provide PoE power on delay function, users can define delay time for PoE power supply
- Supports Auto Negotiation Speed
- Support PTP Client (Precision Time Protocol) clock synchronization
- Support Modbus/TCP protocol
- IGMP v2/v3 (IGMP snooping for support) filtering multicast traffic
- Port Trunking for easy of bandwidth management
- Event notification through Syslog, Email, SNMP trap, and Relay Output
- RMON for traffic monitoring
- Support LLDP protocol
- Port lock to prevent access from unauthorized MAC address
- Windows utility (Open-Vision) support centralized management and configurable by Web-based, Telnet, Console (CLI)
- Support two Gigabit combo ports
- Rigid IP-30 housing design
- DIN-Rail and wall mounting enabled
- Multiple notification for warning of unexpected event
- Web-based, Telnet, Console (CLI), and Windows Utility (**Open-Vision**) configuration
- Provided 2-sets digital input and 2-sets digital output
- Support LLDP Protocol



*NOTE: This function is available by request only

Introduction

IPS-3082GC-24V is managed redundant ring Ethernet switch with 8x10/100Base-T(X) ports with 15.4Watts PoE (P.S.E.) function and 2xGigabit combo ports. With completely support of Ethernet redundancy protocol, O-Ring (recovery time < 10/30ms over 250 units of connection), O-Chain, MRP^{*NOTE} and MSTP/RSTP/STP (IEEE 802.1s/w/D) can protect your mission-critical applications from network interruptions or temporary malfunctions with its fast recovery technology. Another O-Chain is the revolutionary network redundancy technology that provides the add-on network redundancy topology for any backbone network, O-Chain allows multiple redundant network rings of different redundancy protocols to join and function together as a larger and more robust compound network topology. O-Chain providing ease-of-use while maximizing fault-recovery swiftness, flexibility, compatibility, and cost-effectiveness in one set of network redundancy topology. IPS-3082GC-24V also supports Power over Ethernet, a system to transmit electrical power, along with data, to remote devices over standard twisted-pair cable in an Ethernet network. Each IPS-3082GC-24V switch had 8X10/100Base-T(X) 15.4Watts P.S.E. (Power Sourcing Equipment) ports. P.S.E. is a device (switch or hub for instance) that will provide power in a PoE setup. IPS-3082GC-24V supports DDM (Digital Diagnostic Monitoring) function, which can monitor instantly the status of electronic voltage, current and temperature. All function of IPS-3082GC-24V can be managed centralized by a powerful windows utility — Open-Vision. In addition, the wide operating temperature range from -40 to 70°C can satisfy most of operating environment. Therefore, these switches are one of the most reliable choice for highly-managed and Fiber Ethernet application with PoE function.

- **O-Ring:** O-Ring is O-Ring's proprietary redundant ring technology, with recovery time of less 10/30 milliseconds and up to 250 nodes. The O-Ring redundant ring technology can protect mission-critical application from network interruptions or temporary malfunction with its fast recover technology.

NOTE 1. Fast Ethernet ports supports less 10 milliseconds recovery time.

NOTE 2. Gigabit Ethernet ports supports less 30 milliseconds recovery time.

- 0-Chain:** 0-Chain is the revolutionary network redundancy technology that provides the add-on network redundancy topology for any backbone network, 0-Chain allows multiple redundant network rings of different redundancy protocols to join and function together as a larger and more robust compound network topology. 0-Chain providing ease-of-use while maximizing fault-recovery swiftness, flexibility, compatibility, and cost-effectiveness in one set of network redundancy topology.
- MRP: Media Redundancy Protocol (MRP)** ^{*NOTE} is a data network protocol standardized by the IEC 62439-2. It allows rings of Ethernet switches to overcome any single failure with recovery time much faster than achievable with Spanning Tree Protocol.
- Modbus TCP:** This is a Modbus variant used for communications over TCP/IP networks.

***NOTE: This function is available by request only**

Open-Vision

ORing's switches are intelligent switches. Different from other traditional redundant switches, ORing provides a set of Windows Utility (Open-Vision) for user to manage and monitor all industrial Ethernet switches on the industrial network.

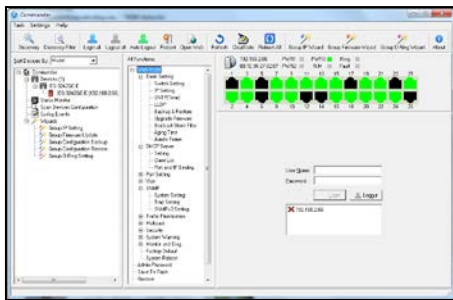

Commander

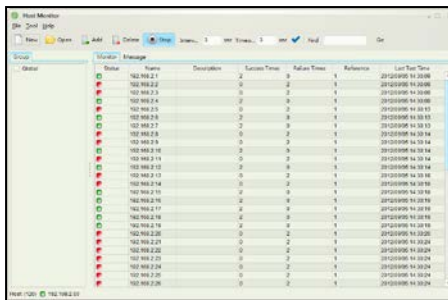

Host Monitor

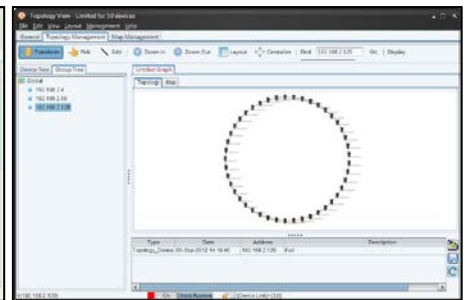

Topology View

Dimensions

Unit =mm (Tolerance ±0.5mm)

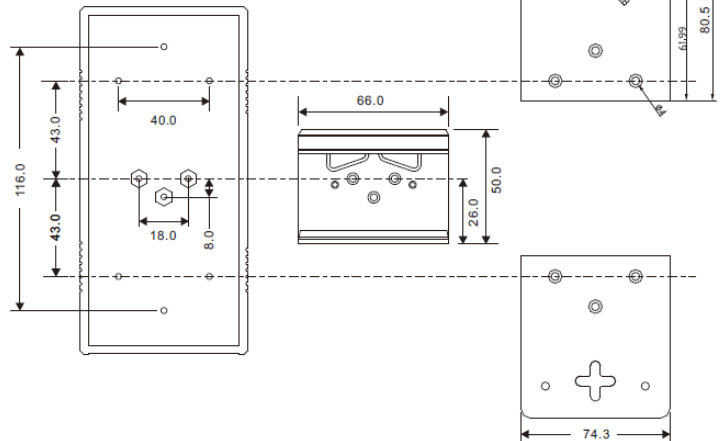
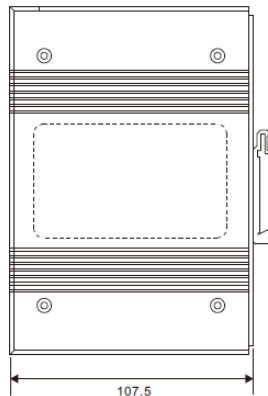
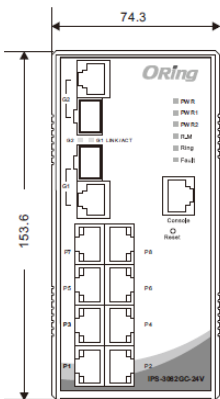
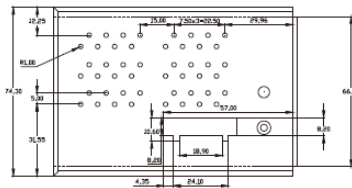

Specifications

ORing Switch Model	IPS-3082GC-24V
Physical Ports	
10/100Base-T(X) Ports in RJ45 Auto MDI/MDIX with P.S.E.	8
Gigabit Combo Ports With 10/100/1000Base-T(X) and 100/1000Base-X SFP Port	2
Technology	
Ethernet Standards	IEEE 802.3 for 10Base-T IEEE 802.3u for 100Base-TX and 100Base-FX IEEE 802.3z for 1000Base-X IEEE 802.3ab for 1000Base-T IEEE 802.3x for Flow control IEEE 802.3ad for LACP (Link Aggregation Control Protocol) IEEE 802.1D for STP (Spanning Tree Protocol) IEEE 802.1p for COS (Class of Service) IEEE 802.1Q for VLAN Tagging IEEE 802.1w for RSTP (Rapid Spanning Tree Protocol) IEEE 802.1s for MSTP (Multiple Spanning Tree Protocol) IEEE 802.1x for Authentication IEEE 802.1AB for LLDP (Link Layer Discovery Protocol) IEEE 802.3af PoE specification (up to 15.4 Watts per port for P.S.E.)
MAC Table	8K
Packet Buffer Size	1Mbits
Priority Queues	4
Processing	Store-and-Forward
Switch Properties	Switching latency: <7 us Switching bandwidth: 7.2Gbps Throughput (packet per second): 4.166Mpps@64Bytes packet Max. Number of Available VLANs: 4096 VLAN ID Range: VID 1 to 4095 IGMP multicast groups: 1024 Port rate limiting: User Define
Security Features	Enable/disable ports, MAC based port security Port based network access control (802.1x) VLAN (802.1Q) to segregate and secure network traffic Supports Q-in-Q VLAN for performance & security to expand the VLAN space Radius centralized password management SNMP V1/V2c/V3 encrypted authentication and access security
Software Features	STP/RSTP/MSTP (IEEE 802.1D/w/s) Redundant Ring (O-Ring) with recovery time less than 10/30ms over 250 units NOTE 1. Fast Ethernet ports supports less 10 milliseconds recovery time. NOTE 2. Gigabit Ethernet ports supports less 30 milliseconds recovery time. TOS/Diffserv supported Quality of Service (802.1p) for real-time traffic VLAN (802.1Q) with VLAN tagging and GVRP supported IGMP Snooping for multicast filtering Port configuration, status, statistics, monitoring, security SNTP for synchronizing of clocks over network Support PTP Client (Precision Time Protocol) clock synchronization DHCP Server / Client support Port Trunk support MVR (Multicast VLAN Registration) support Modbus TCP
Network Redundancy	O-Ring O-Chain MRP *NOTE MSTP/RSTP/STP
RS-232 Serial Console Port	RS-232 in RJ45 connector with console cable. 9600bps, 8, N, 1
LED Indicators	
Power Indicator (PWR)	Green: Power LED x 3
Ring Master Indicator (R.M.)	Green: Indicates that the system is operating in O-Ring Master mode.
O-Ring Indicator (Ring)	Green: Indicates that the system operating in O-Ring mode. Green Blinking: Indicates that the Ring is broken.

*NOTE: This function is available by request only

Fault Indicator (Fault)	Amber: Indicate unexpected event occurred.
10/100Base-T(X) RJ45 Port Indicator	Green for Link/Act indicator: Green for link-up, Off for link-down, Blinking for Act. Amber for Duplex/Collision indicator: on for full-duplex, off for half-duplex, blinking for half-duplex and collision occurred.
10/100Base-T(X) RJ45 PoE Indicator	Green for PoE output indicator: Green for PoE enabled, Off for PoE disabled.
10/100/1000Base-T(X) RJ45 Port Indicator (Combo Port)	Green for Link/Act indicator: Green for link-up, Off for link-down, Blinking for Act. Amber for Speed indicator: Amber for 100Mbps, Off for 10/1000Mbps.
100/1000Base-X SFP Port Indicator (Combo Port)	Green for Link/Act indicator: Green for link-up, Off for link-down, Blinking for Act.
Fault Contact	
Relay	Relay output to carry capacity of 1A at 24VDC
Reset Function	
Reset Button	< 5 sec: System reboot, > 5 sec: Factory default
Power	
Redundant Input Power	Dual DC inputs, 24~36VDC on 6-pin terminal block
Power Consumption (Typ.)	< 12Watts, 24VDC/0.5A, 36VDC/0.33A (power consumption of P.S.E. is not included)
PoE Total Power Budget	< 24VDC@60 Watts Max. > 24VDC@120 Watts Max.
Overload Current Protection	Present
Reverse Polarity Protection	Not Presented
Physical Characteristic	
Enclosure	IP-30 Aluminum
Dimension (W x D x H)	74.3 (W) x 107.5 (D) x 153.6 (H)mm 2.93 (W) x 4.23 (D) x 6.05 (H) inch
Weight (g)	1260 g
Environmental	
Storage Temperature	-40 to 85°C (-40 to 185°F)
Operating Temperature	-40 to 70°C (-40 to 158°F)
Operating Humidity	5% to 95% Non-condensing
Regulatory Approvals	
EMC	CE EMC (EN 55024, EN 55032), FCC Part 15 B
EMI	EN 55032, CISPR32, EN 61000-3-2, EN 61000-3-3, FCC Part 15 B class A
EMS	EN 55024 (IEC/EN 61000-4-2 (ESD: Contact 4KV, Air 8KV), IEC/EN 61000-4-3 (RS: 3V), IEC/EN 61000-4-4 (EFT Power 1KV, Signal 0.5KV), IEC/EN 61000-4-5 (Surge: Power 2KV, RJ45 1KV), IEC/EN 61000-4-6 (CS: 3V), IEC/EN 61000-4-8(PFME), IEC/EN 61000-4-11 (DIP))
Shock	IEC60068-2-27
Free Fall	IEC60068-2-31
Vibration	IEC60068-2-6
Safety	EN 60950-1, UL 60950-1, IEC 60950-1
MTBF	375564.4341 hrs.
Warranty	5 years

Ordering Information

IPS-3AA B CC-24V

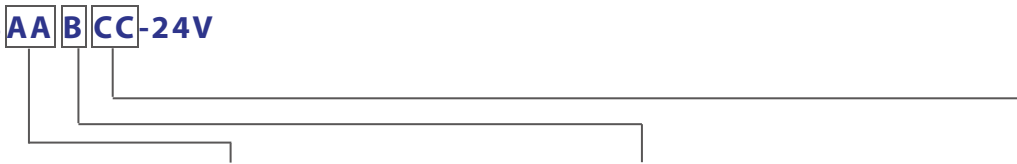

Code Definition	10/100Base-T(X) P.S.E. Port Number	Additional Port Number	Additional Port Type
Option	-8: 8 ports	-2: 2 ports	-GC: Gigabit combo port

Available Model	Model Name	Description
	IPS-3082GC-24V	Industrial 10-port managed PoE Ethernet switch with 8x10/100Base-T(X) P.S.E. and 2xGigabit combo ports, SFP socket, 24VDC power inputs
Packing List <ul style="list-style-type: none"> • IPS-3082GC-24V x 1 • DIN-Rail Kit x 1 • Wall-mount Kit x 2 • ORing Tool CD Card x 1 • Quick Installation Guide x 1 • Console Cable x 1 		Optional Accessories <ul style="list-style-type: none"> • Open-Vision M500: Powerful Network Management Windows Utility Suit, 500 IP devices • SFP100 series: 100Mbps SFP optical transceiver • SFP 1G series: 1Gbps SFP optical transceiver • SDR/NDR Series DIN-Rail power supply

Mouser Electronics

Authorized Distributor

Click to View Pricing, Inventory, Delivery & Lifecycle Information:

ORing:

[IPS-3082GC-24V](#) [IPS-3082GC-AT](#)