



Adafruit CC3000 WiFi

Created by Rick Lesniak



<https://learn.adafruit.com/adafruit-cc3000-wifi>

Last updated on 2024-03-08 01:51:38 PM EST

Table of Contents

Overview	5
Assembly and Wiring	6
CC3000 Breakout	6
<ul style="list-style-type: none">• Assembly• Wiring	
CC3000 Shield	11
<ul style="list-style-type: none">• Assembly	
Connections	15
<ul style="list-style-type: none">• Pinouts• Optional Antenna	
Using the CC3000	16
<ul style="list-style-type: none">• Download the Library• Sample Sketches• WEP with HEX Passphrases	
buildtest	18
<ul style="list-style-type: none">• buildtest	
WebClient	20
<ul style="list-style-type: none">• WebClient	
ntpTest	21
<ul style="list-style-type: none">• ntpTest	
InternetTime	23
<ul style="list-style-type: none">• InternetTime	
GeoLocation	24
<ul style="list-style-type: none">• GeoLocation	
SmartConfig	25
<ul style="list-style-type: none">• SmartConfigCreate and SmartConfigReconnect• SmartConfigCreate• SmartConfigReconnect• Using the SmartConfigCreate Sketch• Step One: Install the SmartConfig App• Step Two: Configure the SmartConfig App on your Phone• Step Three: Open and Run 'SmartConfigCreate'• Step Four: Start the SmartConfig app on your Phone• Step Five: Stop the SmartConfig App on the Phone• Using the SmartConfigReconnect Sketch	
SendTweet	30
<ul style="list-style-type: none">• SendTweet	

Firmware Upgrades	32
Downloads	34
• Files & Downloads	
• Dimensional diagram for the CC3000 breakout	
FAQ	38

Overview

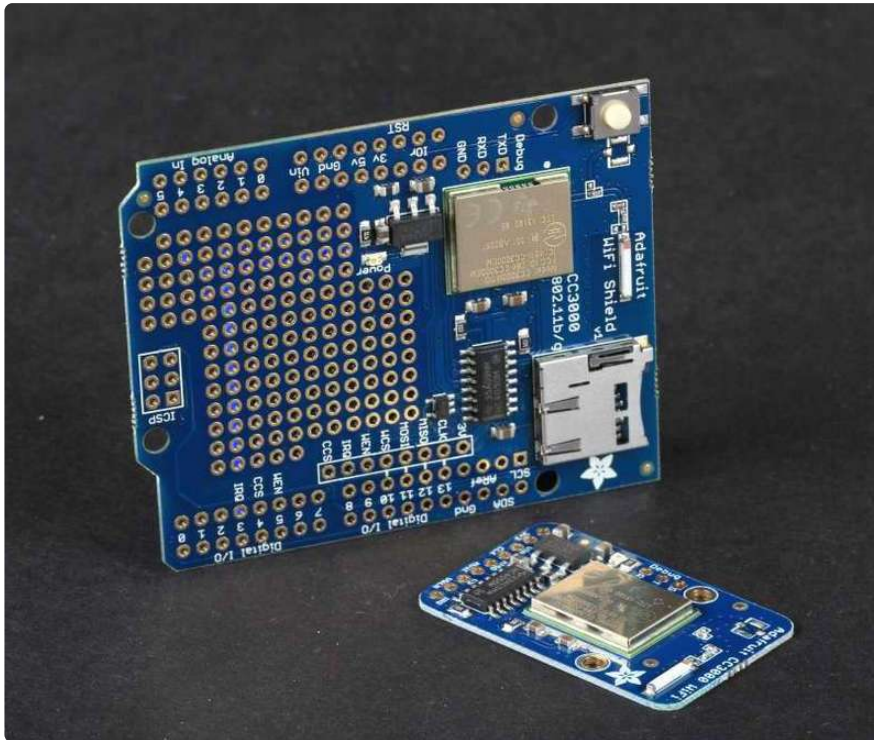

The CC3000 WiFi module from Texas Instruments is a small silver package which finally brings easy-to-use, affordable WiFi functionality to your Arduino projects.

It uses SPI for communication (not UART!) so you can push data as fast as you want or as slow as you want. It has a proper interrupt system with IRQ pin so you can have asynchronous connections. It supports 802.11b/g, open/WEP/WPA/WPA2 security, TKIP & AES. A built in TCP/IP stack with a "BSD socket" interface supports TCP and UDP in both client and server mode, with up to 4 concurrent socket connections.

The CC3000 does not support "AP" mode, it can connect to an access point but it cannot be an access point.

The CC3000 is available from Adafruit As a Breakout Board, and as an Arduino Shield.

Both the shield and the breakout board have an onboard 3.3V regulator that can handle the 350mA peak current, and a level shifter to allow 3 or 5V logic level. The antenna layout is identical to TI's suggested layout and we're using the same components, trace arrangement, and antenna so the board maintains its FCC emitter compliance (you'll still need to perform FCC validation for a finished product, but the WiFi part is taken care of). Even though it's got an onboard antenna we were pretty surprised at the range, as good as a smartphone's.

The shield also features a MicroSD socket, and a reset button.

AND, the shield supports the Arduino SPI passthrough header pins, so it's compatible with the Mega, Leonardo, and Due, right out of the box - no rewiring necessary! Just solder closed the MISO, SCK, and MOSI jumpers on the back of the shield.

Assembly and Wiring



Check out the next couple of pages for detailed instructions for setting up your CC3000 shield or breakout board!

CC3000 Breakout

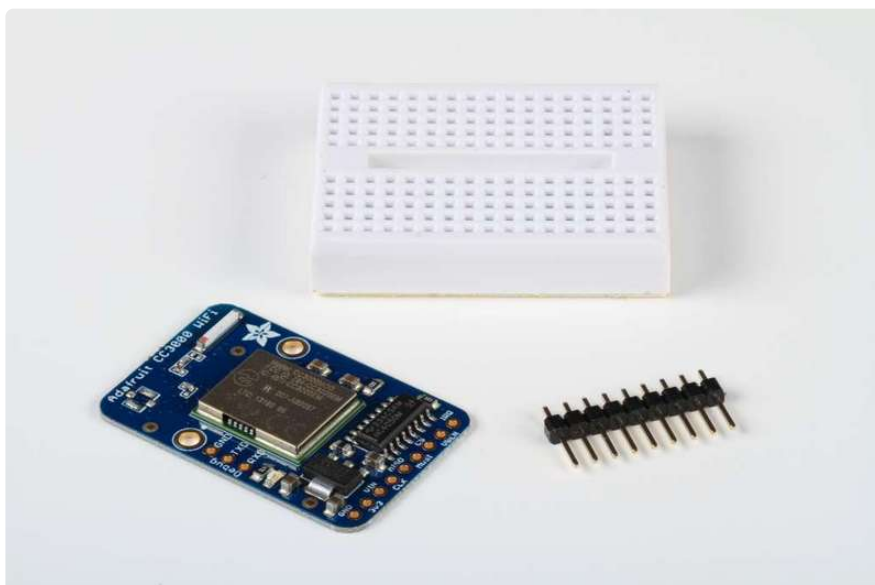

Assembly

The CC3000 breakout board ships with a strip of header pins. Snip off a 9-pin section and solder it to the 9 holes on the side of the board.

The easiest way to do this is to first insert the header pins into a breadboard, to hold them securely while you solder.

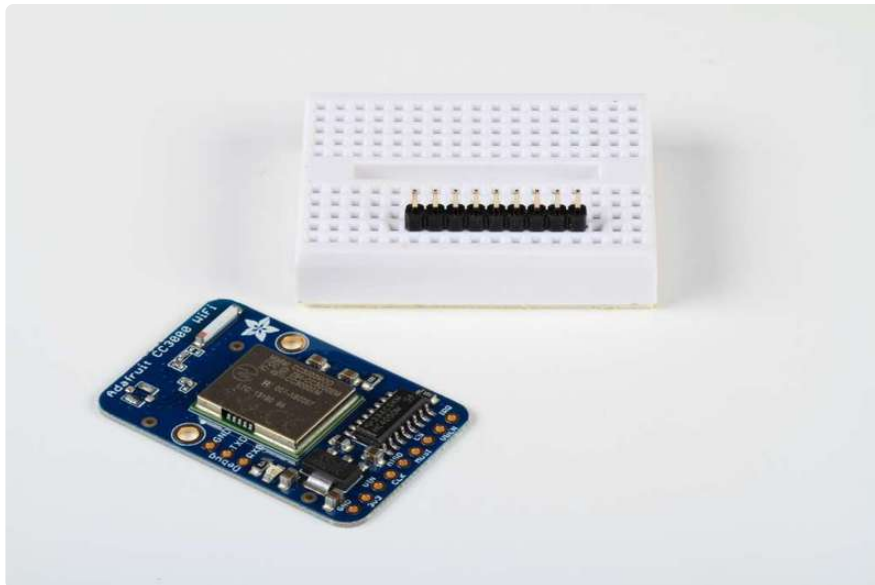

Set the breakout board over the pins, and carefully solder each pin (see our [Guide To Excellent Soldering](https://adafruit.it/aTk) (<https://adafruit.it/aTk>) for instructions and tips on getting the best results).

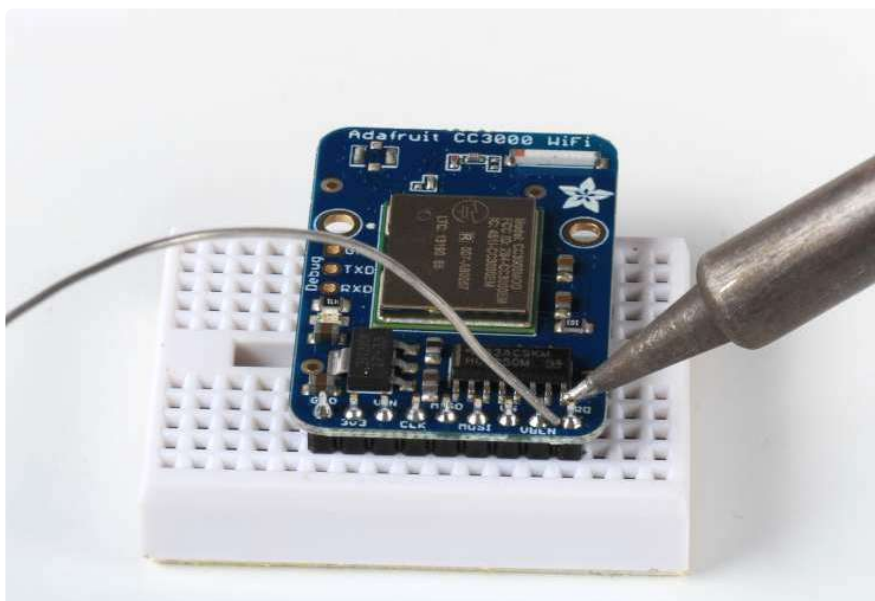

Wiring

Use jumper wires to attach the CC3000 breakout board to your arduino:

Connect GND to one of the Arduino GND pins:
Connect Vin to Arduino +5V

NOTE: If using an Arduino Due, which is not tolerant of 5V on its input pins, you must instead connect the CC3000 3V3 pin to the Due's 3.3V power pin. Don't connect Vin to the Due's +5V!

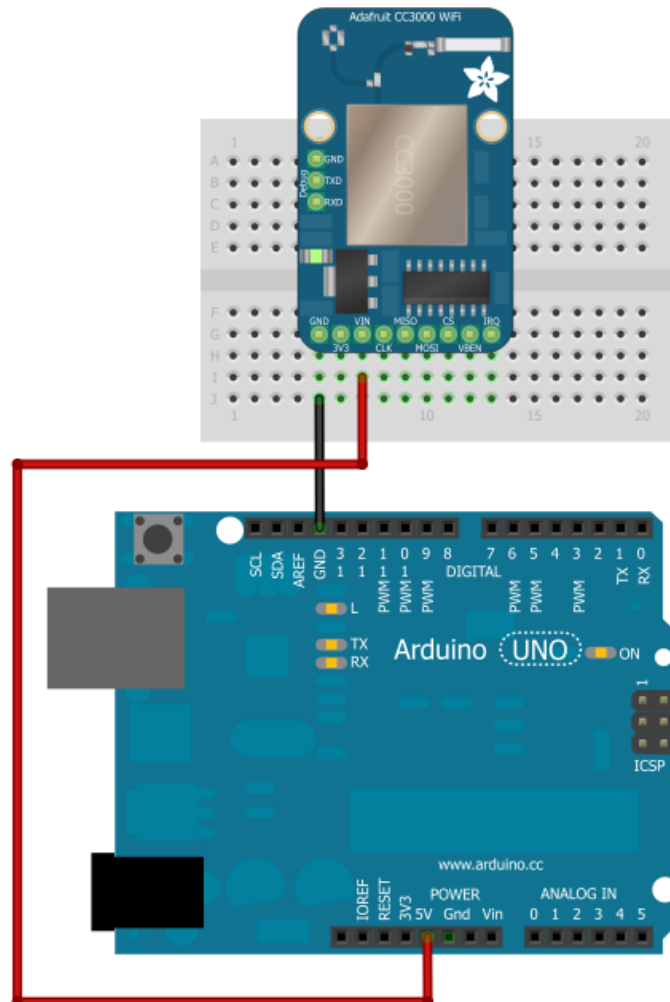

Next, connect the enable and interrupt lines:
VBEN to Digital 5
IRQ to Digital 3

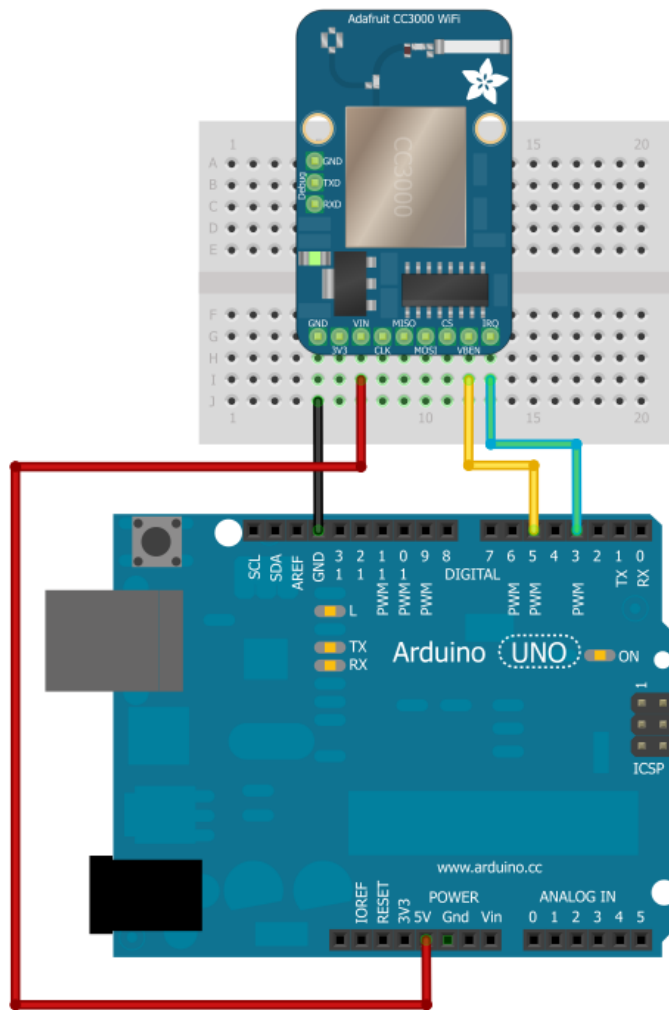

Now, connect SPI:

- CLK to Digital 13
- MISO to Digital 12
- MOSI to Digital 11
- CS to Digital 10

If you're using a Mega, you'll need to connect to the hardware SPI pins:

- CLK to Digital 52
- MISO to Digital 50
- MOSI to Digital 51
- CS to Digital 10

If you're using an Arduino Due, you'll need to connect to the hardware SPI pins. See the [excellent diagram in this forum post \(https://adafru.it/dVz\)](https://adafru.it/dVz) if you aren't sure where

the hardware SPI pins are located on the Due. You want to connect to the SCK, MISO, and MOSI pins on the small 6 pin male header next to the Due's SAM3X8E processor:

- CLK to SPI SCK
- MISO to SPI MISO
- MOSI to SPI MOSI
- CS to Digital 10

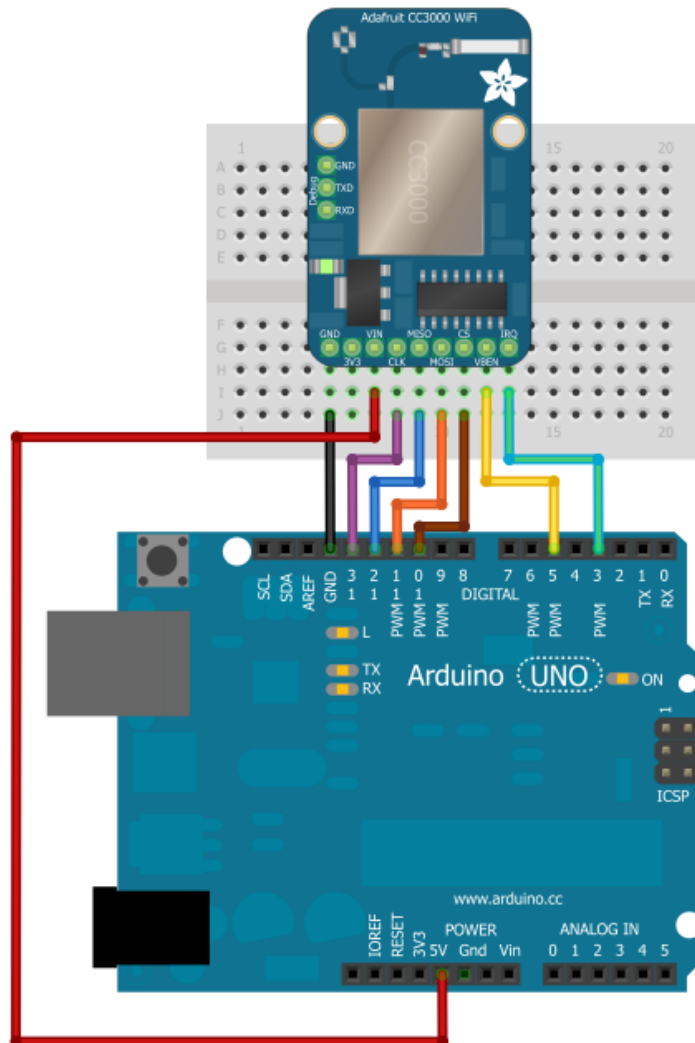

3.3v is an output from the breakout board's voltage regulator - we won't be connecting anything to it in this tutorial.

CC3000 Shield

Assembly



The CC3000 Shield ships with a strip of header pins.

Break off 6, 8, or 10-pin sections and insert them into the header sockets of your Arduino

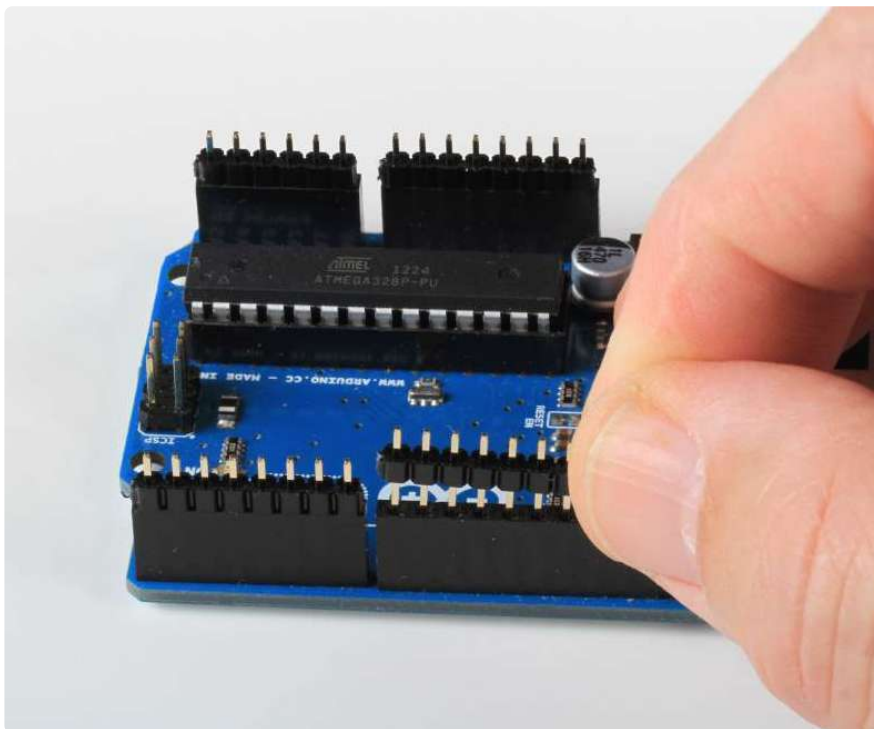

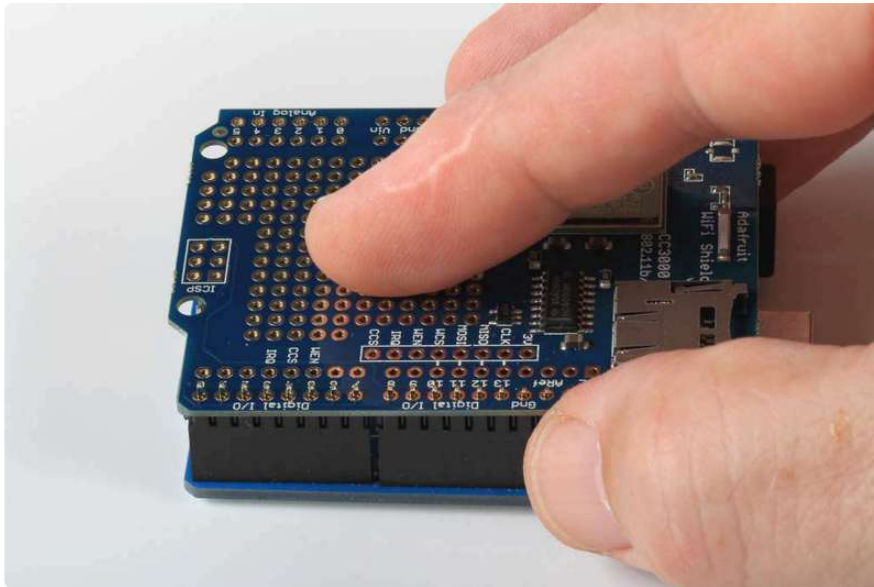

Place the shield over the pins, and carefully solder each one in place (see our [Guide To Excellent Soldering](https://adafruit.it/aTk) (<https://adafruit.it/aTk>) for instructions and tips on getting the best results).

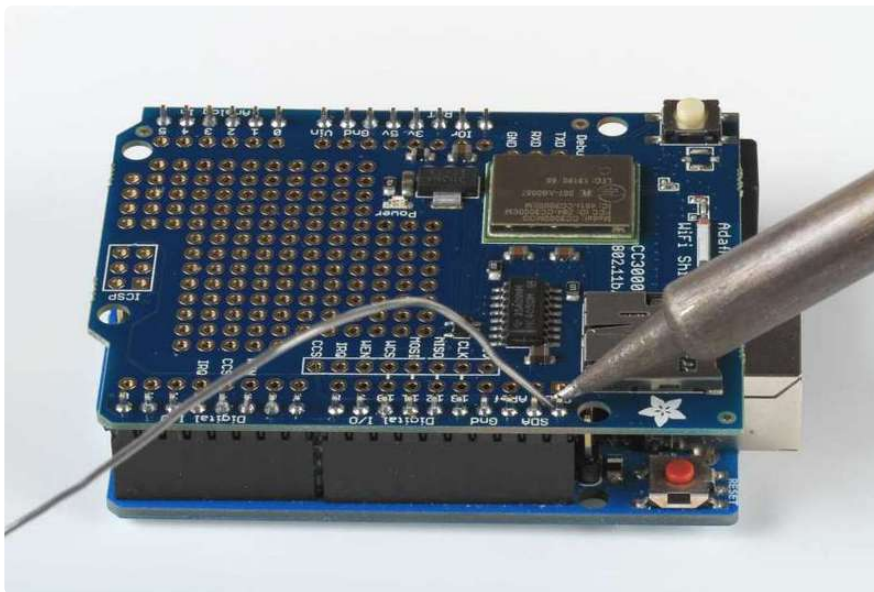

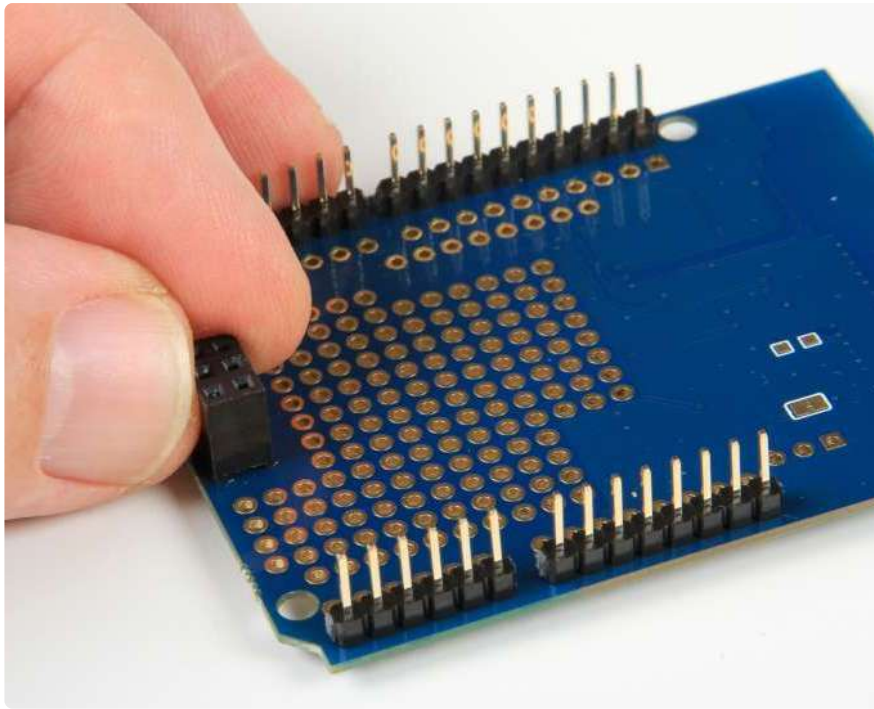

The shield also comes with a 2X3 pin female header socket. This will plug into the 2X3 ICSP pin header on your Arduino, to bring SPI up to the shield. This allows you to use the shield with an Arduino Mega, Leonardo, or Due without having to cut traces or solder jumper wires for SPI.

Set the socket header into the holes on the shield, then flip the shield over and solder the pins. The height of the header block matches the height of the rest of the shield header pins, so the block should be perfectly positioned for soldering!

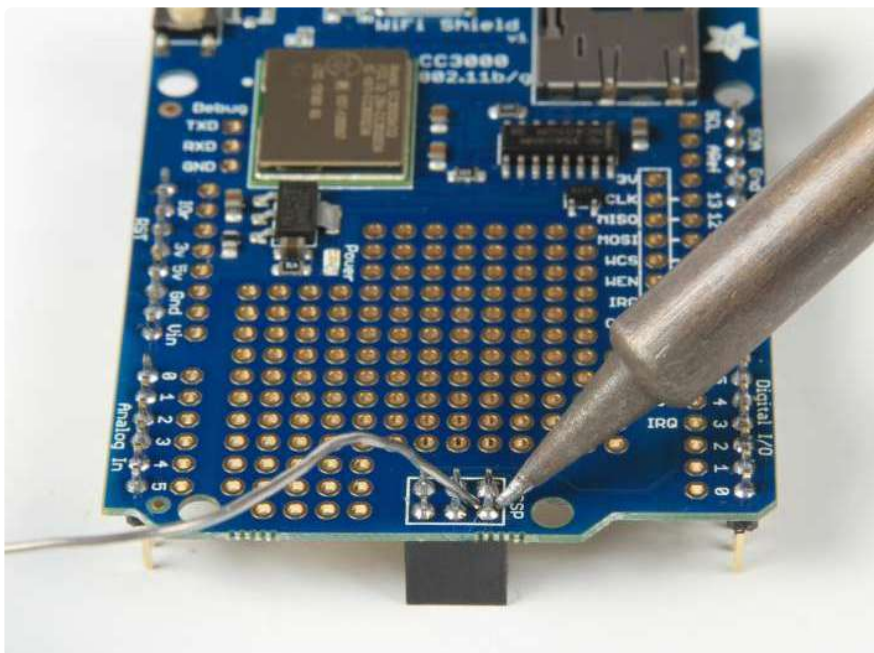

By default, SPI through the ICSP header is not connected. To enable the ICSP header connections, you'll have to connect three solder jumpers on the bottom of the

CC3000 shield.

Soldering these jumpers is required if you are using the shield with a Mega, Leonardo, or Due, but is not required for use with an UNO!

Simply melt a blob of solder, connecting the pads, on each of the three solder jumpers (keep your solder inside the white boxes - don't let the solder cross between boxes!)

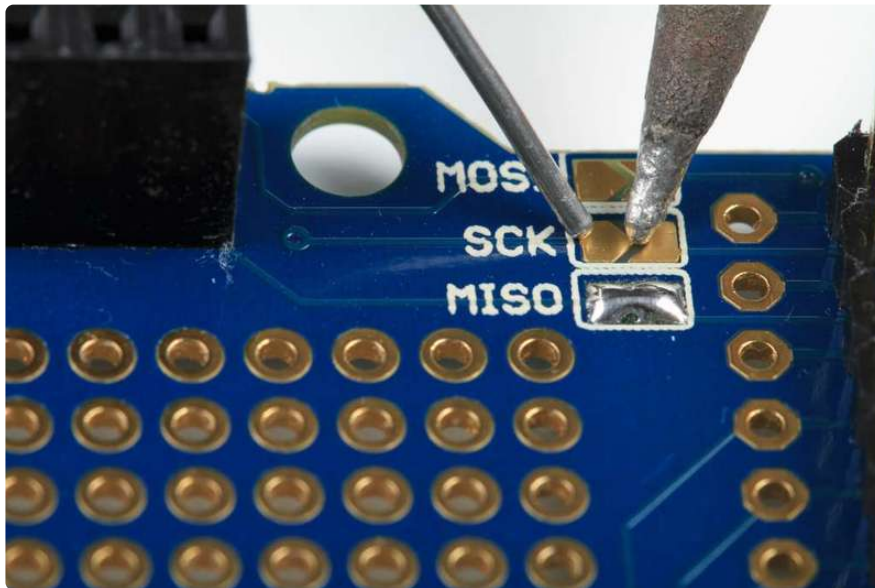

And that's it! Your CC3000 Shield is ready to use. Move on to the next tutorial page to get started!



Connections

Pinouts

The CC3000 is (electrically) fairly simple to use. The module requires an SPI connection, including a clock (CLK), data in from a microcontroller (MOSI) and data out to the microcontroller (MISO). It also uses a chip-select line (CS) for SPI to indicate when a data transfer as started

Along with the SPI interface, there is a power-enable type pin called **VBAT_EN** which we use to start the module properly and also an **IRQ** pin, which is the interrupt from the CC3000. The IRQ pin is required to communicate and must be tied to an interrupt-pin on the Arduino. On the Mega/UNO, we suggest #2 or #3

On the CC3000 shield, we use the following pin connections

- SCK - #13
- MISO #12
- MOSI #11
- CS for CC3000 #10
- VBAT_EN #5

- CS for SD Card #4
- IRQ #3

On the breakout, be aware that the MISO (data out from module) pin does not go 'high impedance' when CS is driven high. Check the shield for how we use a 74AHC125 to manually tri-state this pin when it's shared with an SD card.

Optional Antenna

If you have a shield or breakout with a uFL connector (instead of an on-board ceramic antenna) you can use a [uFL to RP-SMA \(http://adafru.it/852\)](http://adafru.it/852) or [uFL to SMA \(http://adafru.it/851\)](http://adafru.it/851) (less common) adapter and then [connect to any 2.4 GHz antenna \(http://adafru.it/945\)](http://adafru.it/945). This is handy when you want to place the module in a box but have the antenna on the outside, or when you need a signal boost

Please note that when using an external antenna, the module is no longer FCC-compliant, so if you want to sell the product with FCC certification, it must be retested.

Using the CC3000

Make sure your Arduino is powered by a 1 amp or higher rated external power supply when using with the CC3000! Powering an Arduino + CC3000 from a computer/laptop USB port will lead to unstable behavior and lockups because the USB port can't supply enough power!

Use the Arduino 1.6.4 version or newer with the CC3000, EXCEPT for the firmware update sketches in the library examples folder. Use 1.0.6 for those!

Download the Library

We will start by downloading the Adafruit CC3000 Library, available from the Arduino library manager.

Open up the Arduino library manager:

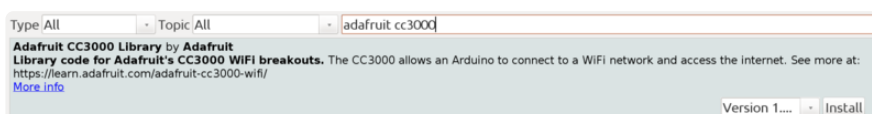

Search for the **Adafruit CC3000** library and install it

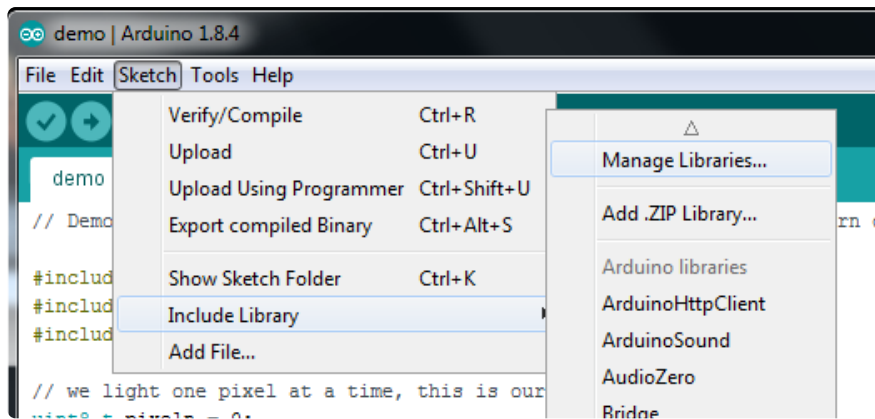

If you're not familiar with installing Arduino libraries, please visit our tutorial: [All About Arduino Libraries \(https://adafru.it/aYM\)](https://adafru.it/aYM)!

Sample Sketches

The Adafruit CC3000 Library contains several example sketches, demonstrating different capabilities of the CC3000 along with some useful programming techniques.

To run the sample sketches, you'll have to edit them to include the SSID and password of your access point.

```
#define WLAN_SSID      "myNetwork"          // cannot be longer than 32 characters!
#define WLAN_PASS     "myPassword"
```

Also, make sure that the right wireless security scheme is selected (unsecured, WEP, WPA, or WPA2)

```
// Security can be WLAN_SEC_UNSEC, WLAN_SEC_WEP, WLAN_SEC_WPA or WLAN_SEC_WPA2
#define WLAN_SECURITY  WLAN_SEC_WPA2
```

WEP with HEX Passphrases

If you are using WEP security, and your passphrase is a series of HEX digits, you can't simply enter it as a literal string. Instead you have to define it as an actual binary sequence.

For example, if your passphrase is 8899aabbccdd, you would define it as follows:

```
// #define WLAN_PASS     "8899aabbccdd" //don't do it this way!
//do it this way:
const char WLAN_PASS[] = {0x88, 0x99, 0xaa, 0xbb, 0xcc, 0xdd, 0x00};
```

Remember to append 0x00 to the declaration, after the passphrase, as shown in the example!

Be aware the library does not currently support WEP passphrases with 0x00 null characters! See this bug for more details: https://github.com/adafruit/Adafruit_CC3000_Library/issues/97

buildtest

buildtest

The **buildtest** sketch does a full test of core WiFi connectivity:

- Initialization
- SSID Scan
- Access Point connection
- DHCP address assignment
- DNS lookup of [www.adafruit.com](https://adafru.it/aK0) (<https://adafru.it/aK0>)
- Ping [www.adafruit.com](https://adafru.it/aK0) (<https://adafru.it/aK0>)
- Disconnect

It's a good idea to run this sketch when first setting up the module. It will let you know that everything is working correctly.

Before you run the sketch, edit it to replace the dummy SSID and password with your own:

```
#define WLAN_SSID      "yourNetwork"          // cannot be longer than 32 characters!  
#define WLAN_PASS     "yourPassword"
```

If you're using WEP, the password should look like this:

```
const char WLAN_PASS[] = {0x1A, 0x2B, 0x3C, 0x4D, 0x5E, 0x00};
```

Since it's a collection of bytes not 'passphrase' style key

Also, make sure that the right wireless security scheme is selected (unsecured, WEP, WPA, or WPA2)

```
// Security can be WLAN_SEC_UNSEC, WLAN_SEC_WEP, WLAN_SEC_WPA or WLAN_SEC_WPA2  
#define WLAN_SECURITY  WLAN_SEC_WPA2
```

Here's a sample of the Serial Monitor output of buildtest. You should see something similar:

```
Hello, CC3000!

RX Buffer : 131 bytes
TX Buffer : 131 bytes
Free RAM: 1237

Initialising the CC3000 ...
Firmware V. : 1.19
MAC Address : 0x08 0x00 0x28 0x01 0xA8 0x8A
Started AP/SSID scan

Networks found: 3
=====
SSID Name      : Extreme
RSSI           : 58
Security Mode: 3

SSID Name      : Express
RSSI           : 59
Security Mode: 3

SSID Name      : fios63
RSSI           : 57
Security Mode: 3
=====

Deleting old connection profiles

Attempting to connect to fios63
Started AP/SSID scan

Connecting to fios63...Waiting to connect...Connected!
Request DHCP

IP Addr: 192.168.1.23
Netmask: 255.255.255.0
Gateway: 192.168.1.1
DHCPsrv: 192.168.1.1
DNSserv: 192.168.1.1
www.adafruit.com > 207.58.139.247

Pinging 207.58.139.247...5 replies
Ping successful!

Closing the connection
```

Make sure you can see and recognize all of the access points around, connect to the access point, get a good connection with DHCP, can do a DNS lookup on [www.adafruit.com \(https://adafru.it/aKO\)](https://adafru.it/aKO) and ping it successfully. If all this works, then your hardware is known good!

WebClient

WebClient

The WebClient sketch does a test of the TCP client capability:

- Initialization
- Optional SSID Scan (uncomment code section to enable)
- Access Point connection
- DHCP address assignment
- DNS lookup of [www.adafruit.com](https://adafru.it/aK0) (<https://adafru.it/aK0>)
- Optional Ping of [www.adafruit.com](https://adafru.it/aK0) (<https://adafru.it/aK0>) (uncomment code section to enable)
- Connect to website and print out webpage contents
- Disconnect

The sketch connects to [www.adafruit.com](https://adafru.it/aK0) (<https://adafru.it/aK0>) and opens a [special webpage](https://adafru.it/cFo) (<https://adafru.it/cFo>) we have prepared for this example. It reads the contents of the page and prints that out to the Serial Monitor.

Before you run the sketch, edit it to replace the dummy SSID and password with your own:

```
#define WLAN_SSID      "yourNetwork"      // cannot be longer than 32 characters!  
#define WLAN_PASS     "yourPassword"
```

Also, make sure that the right wireless security scheme is selected (unsecured, WEP, WPA, or WPA2)

```
// Security can be WLAN_SEC_UNSEC, WLAN_SEC_WEP, WLAN_SEC_WPA or WLAN_SEC_WPA2  
#define WLAN_SECURITY  WLAN_SEC_WPA2
```

Here's a sample of the Serial Monitor output of WebClient. You should see something similar:

```
Hello, CC3000!  
  
Free RAM: 1157  
  
Initializing...  
Started AP/SSID scan  
  
  
  
  
  
  
  
  
  
Connecting to fios63...Waiting to connect...Connected!  
Request DHCP
```

```
IP Addr: 192.168.1.23
Netmask: 255.255.255.0
Gateway: 192.168.1.1
DHCPsrv: 192.168.1.1
DNSserv: 192.168.1.1
www.adafruit.com -&gt; 207.58.139.247
```

```
Connect to 207.58.139.247:80
```

```
-----
HTTP/1.1 200 OK
Date: Thu, 12 Sep 2013 11:04:02 GMT
Server: Apache
Access-Control-Allow-Origin: http://learn.adafruit.com
Access-Control-Allow-Headers: Origin, X-Requested-With, Content-Type, Accept,
Accept-Encoding, Authorization, Referer, User-Agent
Access-Control-Allow-Methods: GET, POST, OPTIONS
Access-Control-Allow-Credentials: true
Access-Control-Max-Age: 1728000
Last-Modified: Thu, 27 Jun 2013 14:13:27 GMT
Accept-Ranges: bytes
Content-Length: 74
Connection: close
Content-Type: text/html
```

```
This is a test of the CC3000 module!
If you can read this, its working :)
-----
```

```
Disconnecting
```

Once you get this working, you can change the webpage you want to access to any kind of webpage on the Internet

ntpTest

ntpTest

The ntpTest sketch does a test of the library's SNTP (Simple Network Time Protocol) client:

- Initialization
- SSID Scan
- Access Point connection
- DHCP address assignment
- SNTP time synchronization
- Extract and print current time and date

The sntp client performs a time synchronization with servers from us.pool.ntp.org and pool.ntp.org. You can also optionally provide it the addresses of one or two of your own time servers. The ntpTest sketch tries time.nist.gov first, before falling back to one of the pool servers.

The client also breaks out the synchronized network time into a structure containing

current date and time fields. The sketch formats and prints this information to the Serial Monitor.

To avoid unnecessary loading of NTP servers, please perform the time synchronization as infrequently as possible. Once per day or longer should be plenty to maintain reasonably accurate time.

Before you run the sketch, edit it to replace the dummy SSID and password with your own:

```
#define WLAN_SSID      "yourNetwork"          // cannot be longer than 32 characters!  
#define WLAN_PASS     "yourPassword"
```

Also, make sure that the right wireless security scheme is selected (unsecured, WEP, WPA, or WPA2)

```
// Security can be WLAN_SEC_UNSEC, WLAN_SEC_WEP, WLAN_SEC_WPA or WLAN_SEC_WPA2  
#define WLAN_SECURITY  WLAN_SEC_WPA2
```

Here's a sample of the Serial Monitor output of ntpTest. You should see something similar:

```
      Hello, CC3000!  
  
Free RAM: 843  
  
Initialising the CC3000 ...  
Firmware V. : 1.19  
  
Deleting old connection profiles  
  
Attempting to connect to fios63  
Started AP/SSID scan  
  
  
  
Connecting to fios63...Waiting to connect...Connected!  
Request DHCP  
UpdateNTPTime  
Current local time is:  
7:18:52.65445  
Thursday, September 12, 2013  
Day of year: 255  
  
Closing the connection
```

InternetTime

InternetTime

The InternetTime sketch is a simplified version of the ntpTest sketch. It does not use the library's SNTP client, but directly queries an NTP time server from pool.ntp.org to get the current "UNIX time" (seconds since 1/1/1970, UTC (GMT)).

The sketch then uses the Arduino's internal timer to keep relative time. The clock is re-synchronized roughly once per day. This minimizes NTP server misuse/abuse.

The RTCLib library (a separate download, and not used here) contains functions to convert UNIX time to other formats if needed.

To avoid unnecessary loading of NTP servers, please perform the time synchronization as infrequently as possible. Once per day or longer should be plenty to maintain reasonably accurate time.

Before you run the sketch, edit it to replace the dummy SSID and password with your own:

```
#define WLAN_SSID      "yourNetwork"          // cannot be longer than 32 characters!  
#define WLAN_PASS     "yourPassword"
```

Also, make sure that the right wireless security scheme is selected (unsecured, WEP, WPA, or WPA2)

```
// Security can be WLAN_SEC_UNSEC, WLAN_SEC_WEP, WLAN_SEC_WPA or WLAN_SEC_WPA2  
#define WLAN_SECURITY  WLAN_SEC_WPA2
```

Here's a sample of the Serial Monitor output of InternetTime. You should see something similar:

```
Hello, CC3000!  
  
RX Buffer : 131 bytes  
TX Buffer : 131 bytes  
  
Initialising the CC3000 ...  
Firmware V. : 1.19  
MAC Address : 0x08 0x00 0x28 0x01 0xA8 0x8A  
  
Deleting old connection profiles  
  
Attempting to connect to fios63  
Started AP/SSID scan
```

```
Connecting to fios63...Waiting to connect...Connected!  
Request DHCP
```

```
IP Addr: 192.168.1.23  
Netmask: 255.255.255.0  
Gateway: 192.168.1.1  
DHCPsrv: 192.168.1.1  
DNSserv: 192.168.1.1  
Locating time server...  
Attempting connection...  
Connect to 62.116.162.126:123  
connected!  
Issuing request...  
Awaiting response...OK  
Current UNIX time: 1378987424 (seconds since 1/1/1970 UTC)  
Current UNIX time: 1378987439 (seconds since 1/1/1970 UTC)  
Current UNIX time: 1378987454 (seconds since 1/1/1970 UTC)  
Current UNIX time: 1378987469 (seconds since 1/1/1970 UTC)  
... etc ...
```

GeoLocation

GeoLocation

This example sketch queries the freegeoip.net service to get the local approximate geographic location based on IP address.

Combined with code in the ntpTest or InternetTime sketches, this can give absolute position and time, extremely useful for seasonal calculations like sun position, insolation, day length, etc. One could always add a GPS module or just plug in values from your GPS or phone, but for applications where extreme accuracy isn't required, this has the luxury of coming 'free' with the CC3000 already in use.

Positional accuracy depends on the freegeoip.net database, in turn based on data collected by maxmind.com. No guarantees this will work for every location. This software is provided as-is.

Position should be polled only once, at startup, or very infrequently if making a mobile network-hopping thing, so as not to overwhelm the kindly-provided free geolocation service.

Before you run the sketch, edit it to replace the dummy SSID and password with your own:

```
#define WLAN_SSID      "yourNetwork"    // cannot be longer than 32 characters!  
#define WLAN_PASS     "yourPassword"
```

Also, make sure that the right wireless security scheme is selected (unsecured, WEP, WPA, or WPA2)

```
// Security can be WLAN_SEC_UNSEC, WLAN_SEC_WEP, WLAN_SEC_WPA or WLAN_SEC_WPA2
#define WLAN_SECURITY WLAN_SEC_WPA2
```

Here's a sample of the Serial Monitor output of GeoLocation. You should see something similar:

```
Hello, CC3000!
Free RAM: 837
Initializing...OK.
Connecting to network...Started AP/SSID scan

Connecting to Turlingdrome...Waiting to connect...connected!
Requesting address from DHCP server...OK

IP Addr: 192.168.0.4
Netmask: 255.255.255.0
Gateway: 192.168.0.1
DHCPsrv: 192.168.0.1
DNSserv: 192.168.0.1

Getting server IP address...192.151.154.154
Connecting to geo server...
Connect to 192.151.154.154:80
connected.
Requesting data...
Reading response...OK

Disconnecting

RESULTS:
  Country: United States
  Region: California
  City: Richmond
  Longitude: -122.35
  Latitude: 37.94
```

SmartConfig

SmartConfig is the special functionality in the CC3000 that allows setting the SSID and password settings without having to type or re-program the module. Any iOS/Android device can be used to set the configuration - solving the annoying deployment problem of how to set the connection details for a new device.

SmartConfigCreate and SmartConfigReconnect

These two SmartConfig sketches should be used together to demonstrate how the SmartConfig app can be used on your smartphone to pass connection details to your CC3000.

SmartConfigCreate

This sketch will initialise the CC3000, erasing any previous connection details stored on the device. It will then enter SmartConfig mode with a 60 second timeout where it waits for configuration data to arrive from the SmartPhone.

If a connection was successfully established, the connection details will be stored in the non-volatile memory of the CC3000, and the module will be configured to automatically reconnect to this network on startup (meaning you don't need to run the SmartConfig app unless your AP details change or you erase the stored connection details on the module).

There's no need to edit the sketch to add your SSID and password - the SmartConfig app does that for you!

SmartConfigReconnect

This sketch shows how to use the CC3000 in 'reconnect' mode, and avoid erasing all stored connection profiles, which is unfortunately necessary with other sketches where manual config data is provided.

- Initializes the CC3000 with a special SmartConfig flag so it doesn't erase the profile data
- Access Point connection (based on saved AP details)
- DHCP address assignment
- Disconnect

SmartConfig is still in beta testing! It might not work on all networks!

Using the SmartConfigCreate Sketch

Step One: Install the SmartConfig App

Before you can use SmartConfig to provide your AP connection details, you need to install the SmartConfig app:

- For **iOS devices** simply search for the [TI WiFi SmartConfig app \(https://adafru.it/cQ3\)](https://adafru.it/cQ3) from the app store.
- For **Android devices**, you can download the app directly from [TI's CC3000 Wiki \(https://adafru.it/cQ4\)](https://adafru.it/cQ4)

Step Two: Configure the SmartConfig App on your Phone

Once you've installed the SmartConfig app, you need to connect to the AP that the CC3000 will be using (HOMENETWORK in the images below), and then load the app.

You should see a screen similar to the following, with the AP's **SSID**, **Gateway IP Address** and **Device Name** fields already populated:

This tutorial will use an iPad to provide the SmartConfig details, but the process is basically the same on Android.

Field	Value
SSID	HOMENETWORK
Password	Password
Gateway IP Address	192.168.0.1
Key	Key
Device Name	CC3000

Start

DESIGNED AND DEVELOPED BY [x]cube LABS

Add the password for your Access Point, but **don't click the START button yet!**

Don't change the Key or DeviceName fields!

Step Three: Open and Run 'SmartConfigCreate'

- In the **File > Examples > Adafruit_CC3000** menu select the **SmartConfigCreate** sketch.
- Run the sketch and open the Serial Monitor via **Tools > Serial Monitor**.
- You should see something similar to the following text:

```
Hello, CC3000!  
  
RX Buffer : 131 bytes  
TX Buffer : 131 bytes  
Free RAM: 595  
  
Initialising the CC3000 ...  
Firmware V. : 1.24  
MAC Address : 0x08 0x00 0x28 0x01 0xA8 0x1F  
Waiting for a SmartConfig connection (~60s) ...
```

Step Four: Start the SmartConfig app on your Phone

Before the Android sketch times out, click to '**Start**' button in your TI app, and watch the serial monitor window of your sketch. After about 30 seconds you should see something similar to the following:

```
Got smart config data  
Saved connection details and connected to AP!  
Request DHCP  
  
IP Addr: 192.168.0.103  
Netmask: 255.255.255.0  
Gateway: 192.168.0.1  
DHCPsrv: 192.168.0.1  
DNSserv: 192.168.0.1  
  
To use these connection details be sure to use  
'begin(false, true)' with your Adafruit_CC3000  
code instead of the default 'begin()' values!  
  
Closing the connection
```

Step Five: Stop the SmartConfig App on the Phone

If everything worked out and you successfully connected to your AP, the connection details were also stored in non-volatile memory on the CC3000 module. You can now use the **SmartConfigReconnect** sketch to test the connection details, specifically paying attention to the extra flags in the **Adafruit_CC3000.begin()** function compared to other sketches..

Did the sketch timeout before connecting?

- Be sure to click 'Stat' in the SmartPhone app as soon as the 'Waiting for SmartConfig connection (~60s) ...' message pops up. The SmartConfig device will timeout after 60 seconds, so you may need to run the sketch again and be a bit quicker with your fingers.
 - Make sure that the iPad or SmartPhone is connected to the same AP that you want the CC3000 to connect to!
 - Check your password in case there is a typo
-

Using the SmartConfigReconnect Sketch

The SmartConfigReconnect sketch shows how to use (and retain) the connection details that were written to the device in the example above.

The key to using and maintaining the connection details is to pass an optional flag to the Adafruit_CC3000 classes `.begin()` function to tell the driver **NOT** to delete existing connections, and to stay in auto connect mode:

```
/* !!!!!!!!!!!!!!!!!!!!!!!!!!!!!!!!!!!!!!!!!!!!!!!!!!!!!!!!!!!!!!!!!!!!!!!!!!!!! */
/* !!! Note the additional arguments in .begin that tell the !!! */
/* !!! app NOT to deleted previously stored connection details !!! */
/* !!! and reconnected using the connection details in memory! !!! */
/* !!!!!!!!!!!!!!!!!!!!!!!!!!!!!!!!!!!!!!!!!!!!!!!!!!!!!!!!!!!!!!!!!!!!!!!!!!!!! */
if (!cc3000.begin(false, true))
{
  Serial.println(F("Unable to re-connect!? Did you run the SmartConfigCreate"));
  Serial.println(F("sketch to store your connection details?"));
  while(1);
}
```

The first flag should always be **false**, and is used to indicate that we are going to perform a firmware update. The second flag should always be **true** when using SmartConfig data, and puts the CC3000 in an auto-reconnect mode and maintains existing connection details in non-volatile memory.

If you were able to successfully connect using the **SmartConfigCreate** sketch, SmartConfigReconnect should give you something similar to the following output:

```
Hello, CC3000!

Trying to reconnect using SmartConfig values ...
Reconnected!

Requesting DHCP

IP Addr: 192.168.0.103
Netmask: 255.255.255.0
Gateway: 192.168.0.1
DHCPsrv: 192.168.0.1
```

```
DNSserv: 192.168.0.1
```

```
Closing the connection
```

Any time you don't provide the extra flags to the `.begin` method, all connection details will be erased and auto-reconnect mode will be disabled! Unfortunately, this is necessary when providing manual connection details, so be careful using non SmartConfig* sketches if you don't want to lose your connection details.

SendTweet

Unfortunately Twitter changed their API and require SSL connections which the CC3000 does not support. This page is only for reference as the SendTweet example does not work anymore and is not included in the latest library.

SendTweet

This example sketch sends “tweets” (Twitter messages) from an Arduino with CC3000 WiFi. Usually this requires extra proxy software running on another computer, but this sketch operates directly from the Arduino.

This is a barebones example that issues a single fixed message, but it’s easily adapted to send different information such as a periodic sensor reading.

In addition to the WiFi setup explained below, it’s necessary to set up a Twitter developer account and complete an application form before this can be used. **That procedure is explained on the [Twitter Setup page of the Internet of Things Printer tutorial](https://adafru.it/cHs)** (<https://adafru.it/cHs>).

One additional configuration step is required on the Twitter developer site: from your applications “Settings” tab, set access to “Read and Write.” This is necessary so our sketch can send tweets; the printer sketch only reads tweets.

Arduino-Tweet-Test

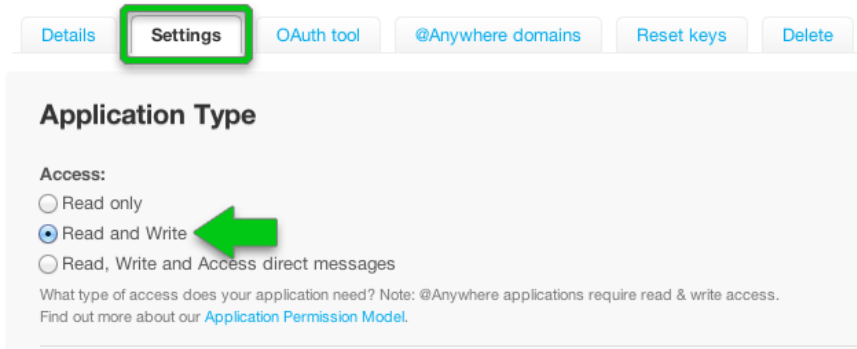

Before you run the sketch, edit it to replace the dummy SSID and password with your own:

```
#define WLAN_SSID      "yourNetwork" // cannot be longer than 32 characters!  
#define WLAN_PASS     "yourPassword"
```

Also, make sure that the right wireless security scheme is selected (unsecured, WEP, WPA, or WPA2)

```
// Security can be WLAN_SEC_UNSEC, WLAN_SEC_WEP, WLAN_SEC_WPA or WLAN_SEC_WPA2  
#define WLAN_SECURITY  WLAN_SEC_WPA2
```

Here's a sample of the Serial Monitor output of SendTweet. You should see something similar:

```
Hello! Initializing CC3000...Firmware V. : 1.19  
OK  
Deleting old connection profiles...OK  
Connecting to network...Started AP/SSID scan  
  
Connecting to Turlingdrome...Waiting to connect...OK  
Requesting address from DHCP server...OK  
IP Addr: 192.168.0.4  
Netmask: 255.255.255.0  
Gateway: 192.168.0.1  
DHCPsrv: 192.168.0.1  
DNSserv: 192.168.0.1  
Locating time server...found  
Connecting to time server...  
Connect to 155.101.3.115:123  
connected!  
Issuing request...OK  
Awaiting response...success!  
Locating Twitter server...OK  
Connecting to server...  
  
Connect to 199.59.150.9:80  
OK  
Issuing HTTP request...OK
```

```
Awaiting response...success!  
Waiting ~1 hour...
```

Firmware Upgrades

The CC3000 is a complex chip that has its own firmware published by Texas Instruments. You might find it necessary to upgrade the firmware, for example to use the latest version with recent bug fixes. Luckily it's easy to upgrade (and downgrade) firmware on the chip using a few included examples in the Adafruit CC3000 Arduino library.

Currently there are two firmware versions provided in the library:

- **Version 1.12** - This is a minor bug fix release with [release notes here \(https://adafru.it/dVA\)](https://adafru.it/dVA).
 - The 1.12 and earlier firmware versions are known to have problems with heavy load and certain network conditions which can cause the CC3000 to lock up. Consider upgrading to the more recent 1.13 release if you run into stability issues.
- **Version 1.13** - This is another bug fix release with [release notes here \(https://adafru.it/dVA\)](https://adafru.it/dVA).
 - The 1.13 release has a fix for internal CC3000 issues which cause lock ups under heavy usage and certain network conditions. However note that the 1.13 release also appears to have [bugs with UDP traffic \(https://adafru.it/dVB\)](https://adafru.it/dVB). Most internet traffic uses TCP instead of UDP so you likely won't run into problems and should consider upgrading to the latest 1.13 firmware.
- **Version 1.14** - This is a bug fix release with [release notes here \(https://adafru.it/dVA\)](https://adafru.it/dVA).

Do not power your Arduino & CC3000 from a computer/laptop USB port during a firmware upgrade! You MUST use an external power supply with at least 1 amp of current capacity. This is to ensure the Arduino and CC3000 have enough power to operate during the firmware upgrade.

Make sure to run firmware updates using Arduino IDE version 1.0.6 and NOT the later beta versions 1.5.7, 1.5.8, or 1.6. The newer toolchain in the beta versions causes problems with the firmware update process.

To upgrade to a specific version first make sure you have the most recent [Adafruit CC3000 Arduino library \(https://adafru.it/cFn\)](https://adafru.it/cFn) installed. If you installed the CC3000 library some time ago make sure to download and install it again as fixes and new firmware versions are added periodically.

Next make sure your CC3000 is wired to your Arduino and can successfully run CC3000 sketches like `buildtest`. If there's a problem communicating with the CC3000 you want to find out before your start the firmware upgrade. **Also be sure you're using a good quality 1 amp or more external power supply and not a computer/laptop USB port to power the Arduino & CC3000!**

Now in the Arduino IDE load one of the `driverpatch_X_XX` CC3000 examples, where X_XX is the version like `driverpatch_1_13` for version 1.13. Adjust any of the pins to communicate with your Arduino just like you would to run `buildtest`. Compile and load the sketch on your Arduino.

Open the serial monitor at 115200 baud and you should see a message such as the following (try pressing the Arduino's reset button if you see no message):

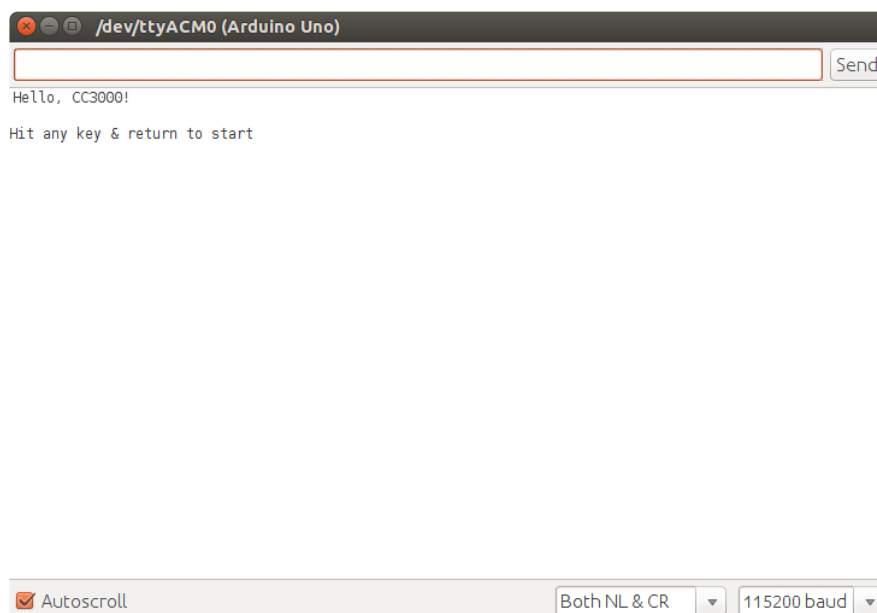

Enter some text and press send to start the firmware upgrade process. The upgrade will happen fairly quickly and should be done in a minute or two. Here's what you should see during an upgrade:

```
/dev/ttyACM0 (Arduino Uno)
Hello, CC3000!
Hit any key & return to start
RX Buffer : 131 bytes
TX Buffer : 131 bytes
Free RAM: 1081 bytes

Initialising the CC3000 ...
Unable to retrieve the firmware version!

MAC Address : 0x08 0x00 0x28 0x59 0x20 0xF8

Read NVRAM $0 0x3, 0x0, 0x1, 0x1, 0x10, 0x10, 0x0, 0x27,
Read NVRAM $8 0x27, 0x27, 0x27, 0x27, 0x27, 0x27, 0x27, 0x27,
Read NVRAM $16 0x27, 0x27, 0x27, 0x27, 0x27, 0x23, 0x25, 0x25,
Read NVRAM $24 0x25, 0x25, 0x25, 0x25, 0x25, 0x25, 0x25, 0x23,
Read NVRAM $32 0x23, 0x23, 0x23, 0x0, 0x0, 0x0, 0x0, 0x0,
Read NVRAM $40 0x0, 0x0, 0x0, 0x0, 0x0, 0x0, 0x0, 0x0,
Read NVRAM $48 0x0, 0x0, 0x0, 0x0, 0x0, 0x0, 0x0, 0x0,
Read NVRAM $56 0x50, 0x50, 0x50, 0x50, 0x50, 0x50, 0x50, 0x50,
Read NVRAM $64 0x50, 0x50, 0x50, 0x50, 0x50, 0x50, 0x50, 0x50,
Read NVRAM $72 0x50, 0x50, 0x50, 0x50, 0x50, 0x50, 0x50, 0x50,
Read NVRAM $80 0x50, 0x50, 0x50, 0x50, 0x50, 0x50, 0x50, 0x50,
Read NVRAM $88 0x50, 0x50, 0x50, 0x1, 0x77, 0x80, 0x50, 0x1F,
Read NVRAM $96 0x22, 0x25, 0x25, 0x27, 0x50, 0x1F, 0x22, 0x25,
Read NVRAM $104 0x25, 0x27, 0x50, 0x1F, 0x22, 0x25, 0x25, 0x27,
Read NVRAM $112 0x1E, 0x20, 0x1, 0x2, 0x2, 0x2, 0x2, 0x0,
Read NVRAM $120 0x11, 0x11, 0x15, 0x11, 0x15, 0xF, 0xE, 0xFF, Wrote FAT entries: 0

Write params
Wrote 32 bytes to NVRAM
Wrote 32 bytes to NVRAM
Wrote 32 bytes to NVRAM
Wrote 32 bytes to NVRAM
Write params
Writing driver patch
Wrote driver patch
Writing firmware
Starting w/patches
Patched!
Firmware V. : 1.28
MAC Address : 0x08 0x00 0x28 0x59 0x20 0xF8

Autoscroll Both NL & CR 115200 baud
```

After the upgrade finishes load the buildtest example and run it again. Confirm that everything works as expected with the connection to your wireless network and ping of adafruit.com. Congratulations you've upgraded the firmware on the CC3000!

Note: The version number displayed during the firmware upgrade and from sketches like buildtest includes the major, minor, and patch numbers so it doesn't exactly match the version number from TI. Here's a handy conversion between reported version number and CC3000 firmware version:

- Buildtest reports version 1.32 = CC3000 firmware v1.14
- Buildtest reports version 1.28 = CC3000 firmware v1.13
- Buildtest reports version 1.26 = CC3000 firmware v1.12
- Buildtest reports version 1.24 = CC3000 firmware v1.11

Downloads

Files & Downloads

- For more information on the CC3000, check out [TI's product page \(https://adafru.it/cHf\)](https://adafru.it/cHf) and [wiki microsite \(https://adafru.it/cHg\)](https://adafru.it/cHg), its got tons and tons of information about their WiFi module
- [EagleCAD PCB files for the breakout on GitHub \(https://adafru.it/reZ\)](https://adafru.it/reZ)
- [EagleCAD PCB files for the shield on GitHub \(https://adafru.it/rf0\)](https://adafru.it/rf0)
- [Fritzing objects available in Adafruit Fritzing library \(https://adafru.it/aP3\)](https://adafru.it/aP3)

- List of wifi access points used to test the CC3000 (by TI, not verified by Adafruit) (<https://adafru.it/rxe>)
- Using an Apple Airport? Check this thread for details on how to set it up for use with the CC3000 (<https://adafru.it/rxf>)

Schematic for the CC3000 breakout board v1.0 (no buffer on the MISO pin)

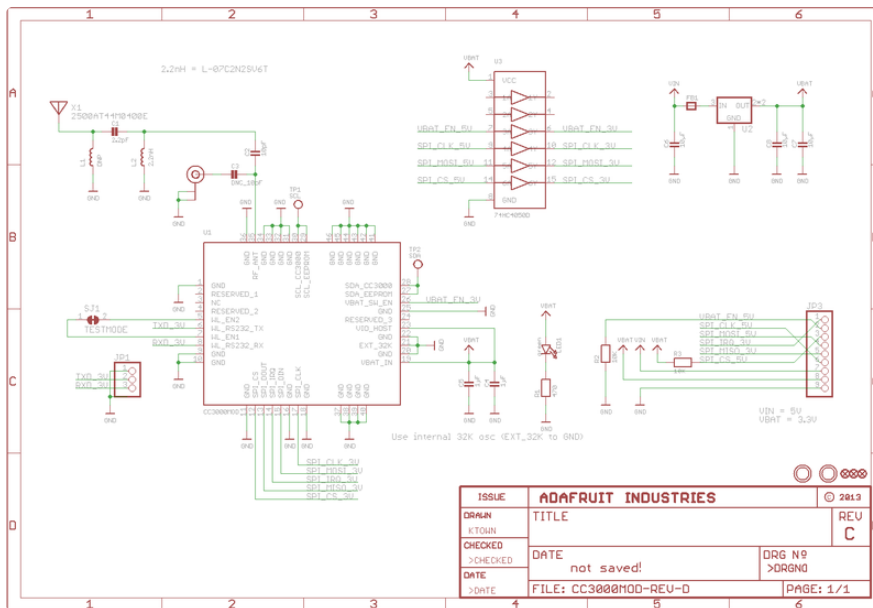

Schematic for v1.1 with a buffer on MISO

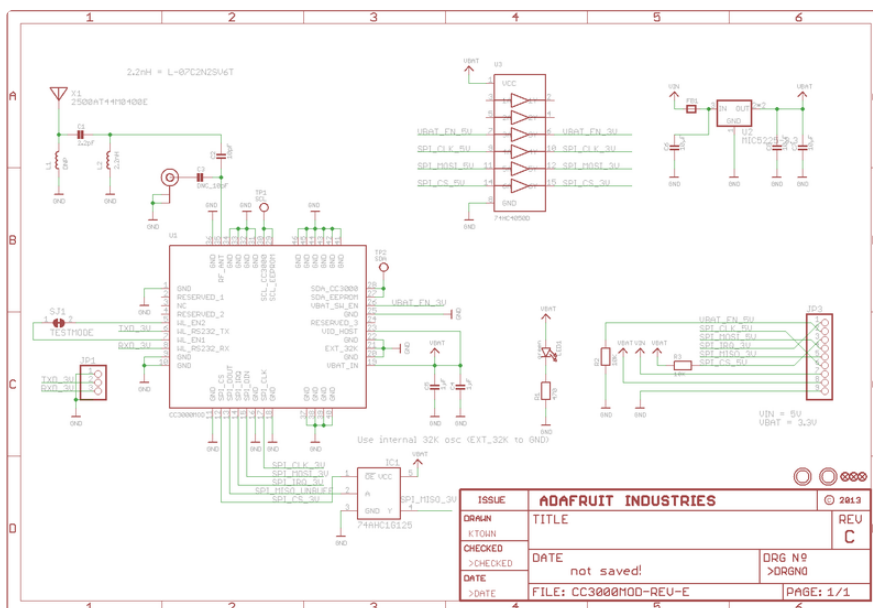

Schematic for the CC3000 shield

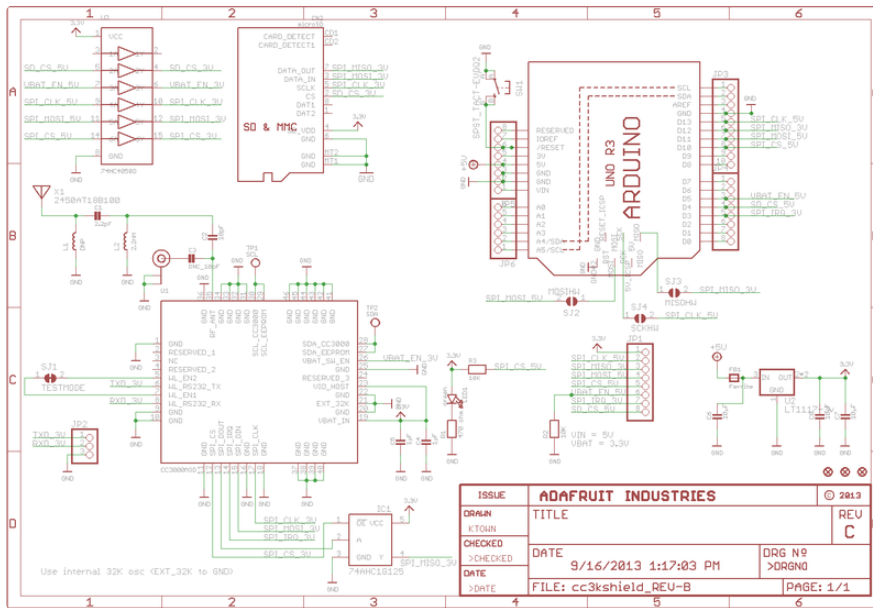

Dimensional diagram for the CC3000 breakout

The dimentions are the same for v1 and v1.1

Inches:

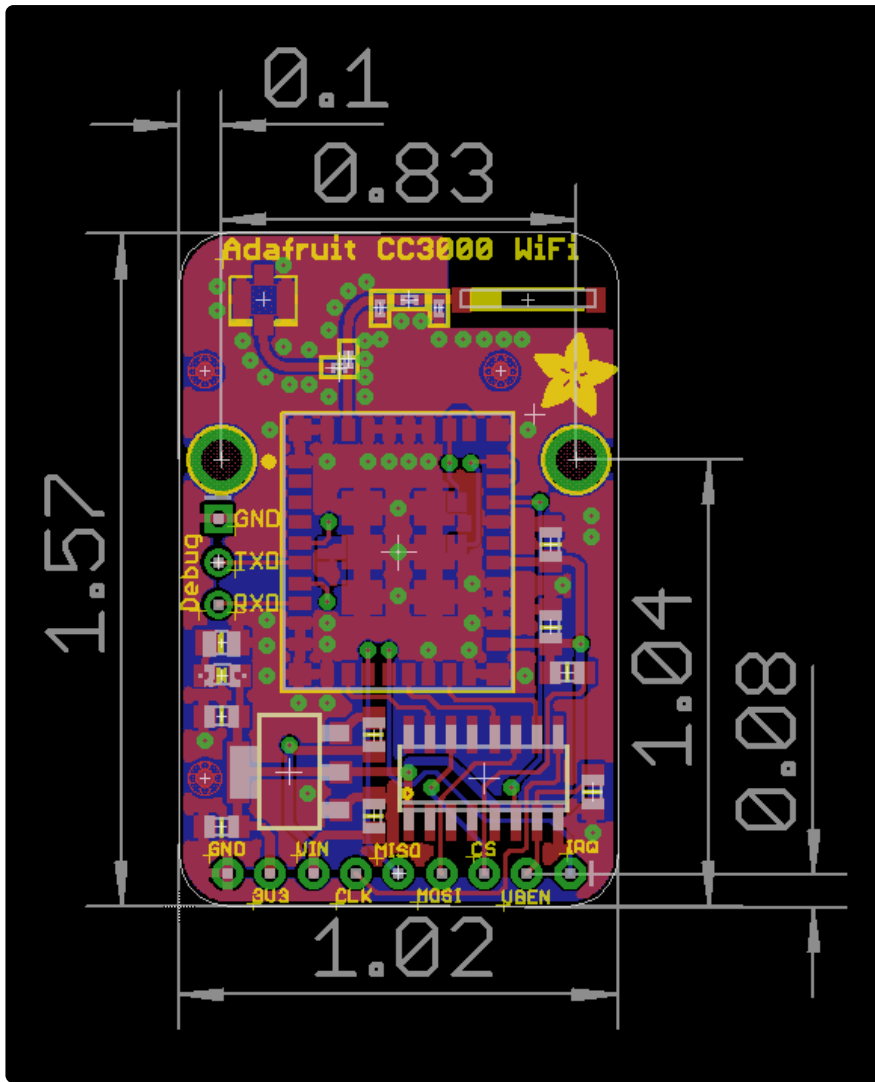

mm:

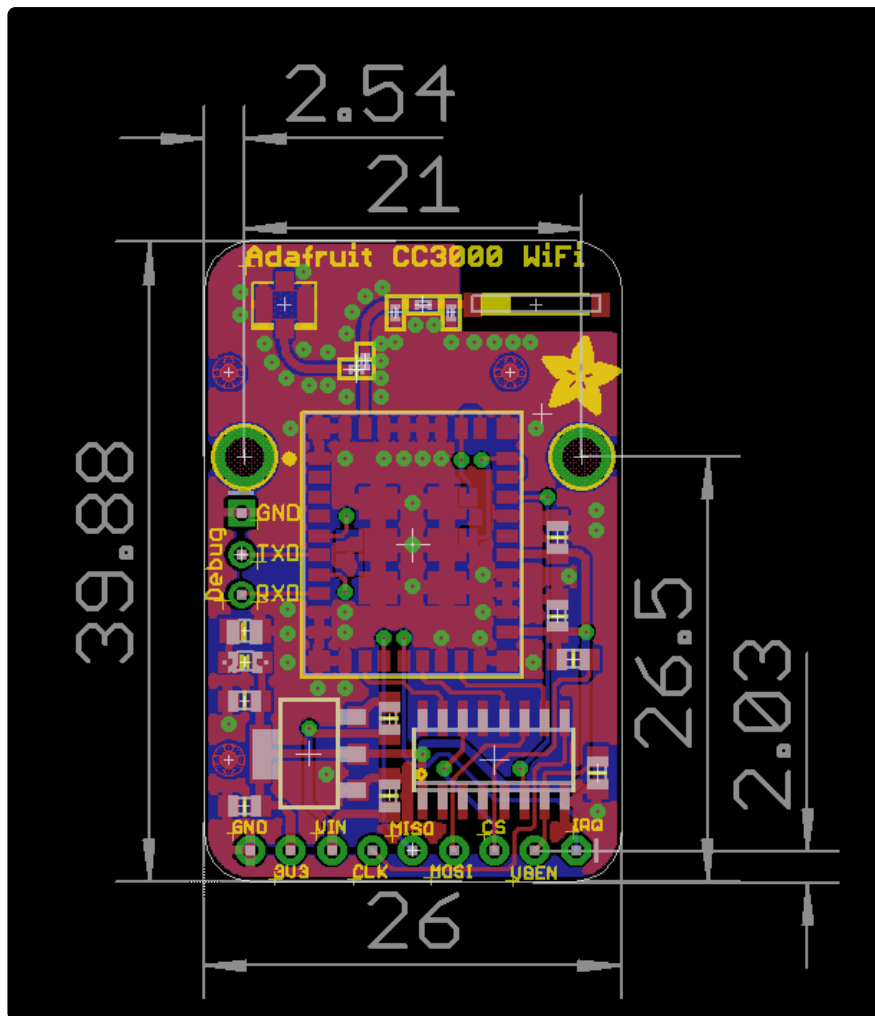

FAQ

I'm using WEP - how do I configure my HEX passphrase?

If your passphrase is a series of HEX digits, you can't simply enter it as a literal string. Instead you have to define it as an actual binary sequence.

For example, if your passphrase is 8899aabbccdd, you would define it as follows (note the 0x00 at the end! It's important!):

```
// #define WLAN_PASS      "8899aabbccdd" //don't do it this way!  
//do it this way:  
const char WLAN_PASS = {0x88, 0x99, 0xaa, 0xbb, 0xcc, 0xdd, 0x00};
```

I'm using WEP and I tried that but it still doesn't work

Make sure you have WLAN_SECURITY defined as WEP:

```
#define WLAN_SECURITY WLAN_SEC_WEP
```

What is the gain of the ceramic antenna? How does it compare to the external antennas?

We use the Johansson [2500AT44M0400 \(https://adafru.it/cVL\)](https://adafru.it/cVL) which has 0.5 dBi gain. Compare this to the external antennas with 2 dBi and 5dBi. Since antenna 'range' is not linear with the gain and antenna range has with what else is transmitting or receiving, physical barriers, noise, etc. We can roughly say that the ceramic antenna has half the range of the 2dBi antenna, and the 5dBi antenna has double the range of the 2dBi antenna

There is no way to know the actual range you will get unless you experiment with your setup since there is so many variables, but the ceramic antenna gets about the same range we expect with an every day cellphone

[\(https://adafru.it/cVL\)](https://adafru.it/cVL)

How can I use the CC3000 with a static IP?

WiFi device IPs are dynamic 99% of the time, but it is possible to assign a static IP if your router permits it. [Check out this forum post for how to go about it \(https://adafru.it/doW\)](https://adafru.it/doW)

I'm having difficulty seeing/connecting to my network...

If you have an '802.11n only' router please configure it to add 'b or g' support. The CC3000 is 802.11b or g only, it does not do 'n'!

I'm not in the USA and my CC3000 can't see my router

The CC3000 only operates on channels 1 through 11. Outside of the United States, you may be able to configure your router to a channel number outside of that range. Make sure your router is configured for a channel in the range 1 through 11.

My CC3000 sketch locks up when initializing the CC3000...

A lockup during initialization is a very common issue when there isn't enough power to supply both the Arduino and CC3000 board. Make sure you're powering the Arduino from a 1 amp or higher rated external power supply. **Don't try to power**

the Arduino from a computer/laptop USB port because those ports typically can't provide enough power and will cause lockups!

If you're using an Arduino UNO you can plug in a 7-12 volt power supply to the barrel jack on the board. A supply like [this 9V 1amp wall wart \(http://adafru.it/63\)](http://adafru.it/63) is perfect for the Arduino UNO and CC3000.

Also if your Arduino supports changing the voltage of the digital I/O pins (like some 3rd party Arduino clones), make sure the voltage is set to 5 volts and not 3.3 volts.

My CC3000 sketch locks up after running for a while or under heavy load...

Unfortunately there is a well known internal issue with the CC3000 which can cause lock ups and instability over time or under heavy load. [This thread on the Spark Core forums \(https://adafru.it/dVC\)](https://adafru.it/dVC) dives deeply into the issue and investigation with Texas Instruments. Ultimately the latest firmware version 1.13 was released with a potential fix for the stability problems. If you'd like to upgrade to firmware version 1.13 see the [page on firmware upgrades in this guide \(https://adafru.it/kA7\)](https://adafru.it/kA7).

How do I set a static IP address?

By default the CC3000 is configured to get an IP address automatically from your router using DHCP. In most cases this works well, however if you run into trouble getting an IP address or DNS server you should consider setting a static IP address and DNS server.

To set a static IP address make sure you have the latest version of the CC3000 library and load the buildtest example. Scroll down to the commented section of code in the setup function which discusses setting a static IP address:

```
/*  
uint32_t ipAddress = cc3000.IP2U32(192, 168, 1, 19);  
uint32_t netMask = cc3000.IP2U32(255, 255, 255, 0);  
uint32_t defaultGateway = cc3000.IP2U32(192, 168, 1, 1);  
uint32_t dns = cc3000.IP2U32(8, 8, 4, 4);  
if (!cc3000.setStaticIPAddress(ipAddress, netMask, defaultGateway, dns)) {  
  Serial.println(F("Failed to set static IP!"));  
  while(1);  
}  
*/
```

Remove the `/*` and `*/` comment delineators and fill in the IP address, net mask, default gateway, and DNS server values for your network. You might need to check your router's configuration page to find these details.

Run the `buildtest` sketch and the CC3000 should be configured to use the static IP address and configuration you assigned. You can actually remove or comment out the IP assignment code because the CC3000 will remember the configuration in its internal non-volatile storage.

If you'd ever like to enable DHCP again, load `buildtest` and uncomment the section below the static IP address configuration:

```
/*  
if (!cc3000.setDHCP()) {  
  Serial.println(F("Failed to set DHCP!"));  
  while(1);  
}  
*/
```

How do I connect to a college/hotel/airport WiFi network that requires using a web page to authenticate?

Unfortunately these networks are difficult or sometimes impossible for the CC3000 to connect to because they require using a web browser to authenticate with the network. However a couple options to pursue are:

- Try contacting the network support team / administrator and see if they can allow the CC3000 onto the network based on its MAC address. When you run the `buildtest` sketch it will print out the CC3000 MAC address so you can copy it from there. This option is the easiest and most reliable way to get onto the network, but might not be available depending on the network's policies.
- The second option is to clone the MAC address of a laptop or device you've gotten on the network already. For this you'll want to find the MAC address of the laptop/computer (usually in network settings, search online to get a direct answer depending on the OS you're using). Then uncomment and adjust the commented code in the `setup` function of the `buildtest` example which sets the MAC address of the CC3000. Fill in your laptop/computer's MAC address and run the sketch to have the CC3000 start using the provided MAC address. Unfortunately at this point you have to turn off the cloned laptop/computer or at least disconnect it from the network because two devices with the same

MAC can't be on the network at the same time (they'll get confused and start seeing each other's traffic).

I'm using the IPAddress class or an example from the Ethernet library and it doesn't work, what's wrong?

The IPAddress class is not compatible with the IP addresses the CC3000 classes expect. However you can switch to using the **CC3000.IP2U32** function to generate an IP address. [See this line in the buildtest example \(https://adafru.it/fli\)](https://adafru.it/fli) for how to use this function, and what type to use to store the IP address (an unsigned 32-bit integer). Unfortunately the Arduino compiler will try to convert an IPAddress into this type so ethernet library code might compile, but when the code actually runs it will fail because the data is not in the right order. Stick to using the IP2U32 function!

Mouser Electronics

Authorized Distributor

Click to View Pricing, Inventory, Delivery & Lifecycle Information:

[Adafruit:](#)

[1534](#) [1491](#) [1510](#) [1469](#) [2891](#)