

# CLA1A-WKW/MKW: PLCC4 1 IN 1 SMD LED



## PRODUCT DESCRIPTION

SMD LEDs is packaged in the industry standard package. These LEDs have high reliability performance and are designed to work under a wide range of environmental conditions. This high reliability feature makes them ideally suited to be used under illumination application conditions.

Its wide viewing angle makes these LEDs ideally suited for channel letter, or general backlighting and illumination applications. The flat top emitting surface makes it easy for these LEDs to mate with light pipes.

## FEATURES

- Size (mm): 3.2 X 2.8
- Color Temperatures:  
Cool White :  
Min . (4600K) / Typical (5500K)  
Warm White :  
Min . (2500K) / Typical (3200K)
- Luminous Intensity (mcd)  
CLA1A-WKW:(1800-4500)  
CLA1A-MKW:(1400-3550)
- CRI:  
Typical CRI for Cool White is 72  
Typical CRI for Warm White is 80
- Lead - Free
- RoHS Compliant

## APPLICATIONS

- Channel Letter

**ABSOLUTE MAXIMUM RATINGS ( $T_A = 25^\circ\text{C}$ )**

Items	Symbol	Absolute Maximum Rating	Unit
Forward Current	$I_F$	35	mA
Peak Forward Current <sup>Note 1</sup>	$I_{FP}$	100	mA
Reverse Voltage	$V_R$	5	V
Power Dissipation	$P_D$	147	mW
Operation Temperature	$T_{opr}$	-40 ~ +100	$^\circ\text{C}$
Storage Temperature	$T_{stg}$	-40 ~ +100	$^\circ\text{C}$
Junction Temperature	$T_J$	110	$^\circ\text{C}$
Junction/Ambient	$R_{THJA}$	350	$^\circ\text{C/W}$
Junction/Solder Point	$R_{THJS}$	200	$^\circ\text{C/W}$

**Note:**

1. Pulse width  $\leq 0.1$  msec, duty  $\leq 1/10$ .

**TYPICAL ELECTRICAL & OPTICAL CHARACTERISTICS ( $T_A = 25^\circ\text{C}$ )**

Characteristics	Color	Symbol	Condition	Unit	Minimum	Typical	Maximum
Forward Voltage	Cool/Warm	$V_F$	$I_F = 30$ mA	V		3.6	4.2
Reverse Current	Cool/Warm	$I_R$	$V_R = 5$ V	$\mu\text{A}$			10
Luminous Flux	Cool	$\Phi_V$	$I_F = 30$ mA	mlm		7000	
	Warm	$\Phi_V$	$I_F = 30$ mA	mlm		6000	
Luminous Intensity	Cool	$I_V$	$I_F = 30$ mA	mcd	1800	2800	
	Warm	$I_V$	$I_F = 30$ mA	mcd	1400	2500	
Chromaticity Coordinates	Cool	x	$I_F = 30$ mA			0.3325	
		y	$I_F = 30$ mA			0.3411	
	Warm	x	$I_F = 30$ mA			0.4234	
		y	$I_F = 30$ mA			0.3990	

- \* Continuous reverse voltage can cause LED damage.

## INTENSITY BIN LIMIT

Cool White (30 mA) - CLA1A-WKW			Warm White (30 mA) - CLA1A-MKW		
Bin Code	Min.(mcd)	Max.(mcd)	Bin Code	Min.(mcd)	Max.(mcd)
Xa	1800	2240	Wb	1400	1800
Xb	2240	2800	Xa	1800	2240
Ya	2800	3550	Xb	2240	2800
Yb	3550	4500	Ya	2800	3550

\* Tolerance of measurement of luminous intensity is  $\pm 10\%$

## VOLTAGE BIN LIMIT

Cool White (30 mA) - CLA1A-WKW			Warm White (30 mA) - CLA1A-MKW		
Bin Code	Min. (V)	Max. (V)	Bin Code	Min. (V)	Max. (V)
27	2.8	3.0	27	2.8	3.0
28	3.0	3.2	28	3.0	3.2
29	3.2	3.4	29	3.2	3.4
2a	3.4	3.6	2a	3.4	3.6
2b	3.6	3.8	2b	3.6	3.8
2c	3.8	4.0	2c	3.8	4.0
2d	4.0	4.2	2d	4.0	4.2

\* Tolerance of measurement of voltage is  $\pm 0.05V$

COLOR BIN LIMIT

Cool White (30 mA) - CLA1A-WKW

Bin Code	Sub-bin	x	y
W1	Wa	0.2545	0.2480
		0.2633	0.2410
		0.2545	0.2245
		0.2450	0.2290
	Wb	0.2633	0.2410
		0.2720	0.2340
		0.2640	0.2200
		0.2545	0.2245
	Wc	0.2545	0.2480
		0.2640	0.2670
		0.2720	0.2575
		0.2633	0.2410
	Wd	0.2633	0.2410
		0.2720	0.2575
		0.2800	0.2480
		0.2720	0.2340
W2	We	0.2640	0.2670
		0.2735	0.2860
		0.2808	0.2740
		0.2720	0.2575
	Wf	0.2720	0.2575
		0.2808	0.2740
		0.2880	0.2620
		0.2800	0.2480
	Wg	0.2735	0.2860
		0.2830	0.3050
		0.2895	0.2905
		0.2808	0.2740
	Wh	0.2808	0.2740
		0.2895	0.2905
		0.2960	0.2760
		0.2880	0.2620

Bin Code	Sub-bin	x	y
W3	Wj	0.2830	0.3050
		0.2950	0.3210
		0.2998	0.3028
		0.2895	0.2905
	Wk	0.2895	0.2905
		0.2998	0.3028
		0.3045	0.2865
		0.2960	0.2760
	Wm	0.2950	0.3210
		0.3070	0.3370
		0.3100	0.3150
		0.2998	0.3028
	Wn	0.2998	0.3028
		0.3100	0.3150
		0.3130	0.2970
		0.3045	0.2865
W4	Wp	0.3070	0.3370
		0.3185	0.3485
		0.3200	0.3270
		0.3100	0.3150
	Wq	0.3100	0.3150
		0.3200	0.3270
		0.3215	0.3075
		0.3130	0.2970
	Wr	0.3185	0.3485
		0.3300	0.3600
		0.3300	0.3390
		0.3200	0.3270
	Ws	0.3200	0.3270
		0.3300	0.3390
		0.3300	0.3180
		0.3215	0.3075

Bin Code	Sub-bin	x	y
W5	Wt	0.3300	0.3600
		0.3455	0.3725
		0.3443	0.3535
		0.3300	0.3390
	Wu	0.3300	0.3390
		0.3443	0.3535
		0.3430	0.3345
		0.3300	0.3180
	Wv	0.3455	0.3725
		0.3610	0.3850
		0.3585	0.3680
		0.3443	0.3535
	Ww	0.3443	0.3535
		0.3585	0.3680
		0.3560	0.3510
		0.3430	0.3345

\* Tolerance of measurement of the color coordinates is ±0.01

COLOR BIN LIMIT

Warm White (30 mA) - CLA1A-MKW

Bin Code	Sub-bin	x	y
M1	Ma	0.3610	0.3900
		0.3576	0.3651
		0.3751	0.3783
		0.3820	0.4075
	Mb	0.3576	0.3651
		0.3541	0.3401
		0.3682	0.3491
		0.3749	0.3781
	Mc	0.3820	0.4075
		0.3751	0.3783
		0.3926	0.3915
		0.4030	0.4250
	Md	0.3751	0.3783
		0.3682	0.3491
		0.3822	0.3580
		0.3926	0.3915

Bin Code	Sub-bin	x	y
M2	Me	0.4030	0.4250
		0.3926	0.3915
		0.4118	0.4021
		0.4260	0.4390
	Mf	0.3926	0.3915
		0.3822	0.3580
		0.3976	0.3653
		0.4118	0.4021
	Mg	0.4260	0.4390
		0.4118	0.4021
		0.4310	0.4128
		0.4490	0.4530
	Mh	0.4118	0.4021
		0.3976	0.3653
		0.4129	0.3725
		0.4310	0.4128

Bin Code	Sub-bin	x	y
M3	Mj	0.4490	0.4530
		0.4310	0.4128
		0.4572	0.4203
		0.4785	0.4625
	Mk	0.4310	0.4128
		0.4129	0.3726
		0.4359	0.3782
		0.4572	0.4203
	Mm	0.4785	0.4625
		0.4572	0.4203
		0.4834	0.4279
		0.5080	0.4720
	Mn	0.4572	0.4203
		0.4359	0.3782
		0.4588	0.3838
		0.4834	0.4279

\* Tolerance of measurement of the color coordinates is ±0.01

CIE CHROMATICITY DIAGRAM

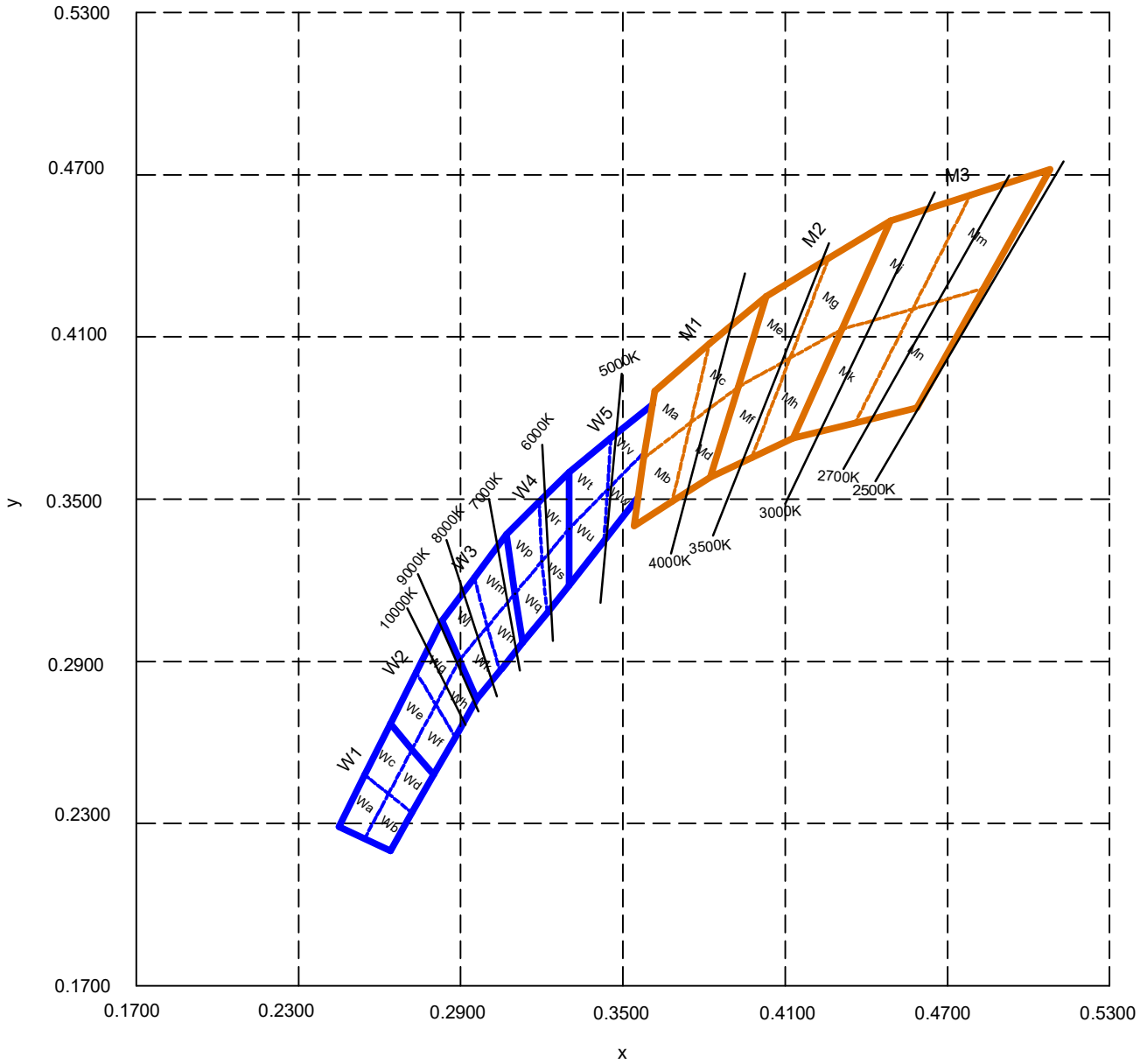

## ORDER CODE TABLE

Color	Kit Number	Luminous Intensity (mcd)		Color Bin Code
		Min.	Max.	
Cool White	CLA1A-WKW-CXaYb153	1800	4500	W1,W2,W3,W4,W5
	CLA1A-WKW-CXaYb453	1800	4500	W4,W5
	CLA1A-WKW-CXbYb453	2240	4500	W4,W5

Color	Kit Number	Luminous Intensity (mcd)		Color Bin Code
		Min.	Max.	
Warm White	CLA1A-MKW-CWbYa133	1400	3550	M1,M2,M3
	CLA1A-MKW-CWbYa513	1400	3550	W5,M1
	CLA1A-MKW-CWbYa233	1400	3550	M2,M3
	CLA1A-MKW-CXaYa233	1800	3550	M2,M3
	CLA1A-MKW-CXaYa513	1800	3550	W5,M1

### Notes:

- The above kit numbers represent order codes that include multiple intensity-bin and color-bin codes. Only one intensity-bin code and one color-bin code will be shipped on each bulk. Single intensity-bin code and single color-bin codes will not be orderable.
- Please refer to the [HB LED Lamp Reliability Test Standards](#) document for reliability test conditions.
- Please refer to the [HB LED Lamp Soldering & Handling](#) document for information about how to use this LED product safely.

GRAPHS

The data below are collected from statistical figures that do not necessarily correspond to the actual parameters of each single LED. Hence, these data will be changed without further notice.

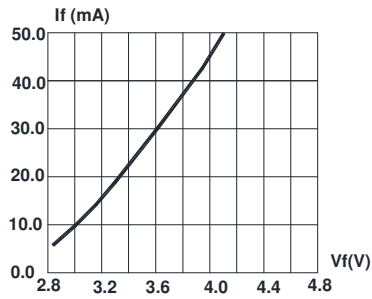

FIG.1 FORWARD CURRENT VS. FORWARD VOLTAGE.

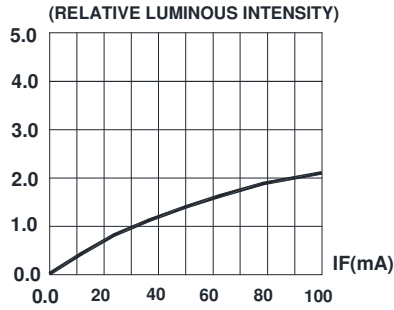

FIG.2 RELATIVE LUMINOUS INTENSITY VS. FORWARD CURRENT

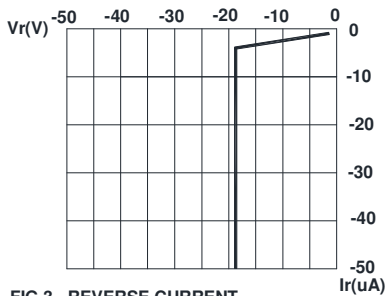

FIG.3 REVERSE CURRENT VS. REVERSE VOLTAGE.

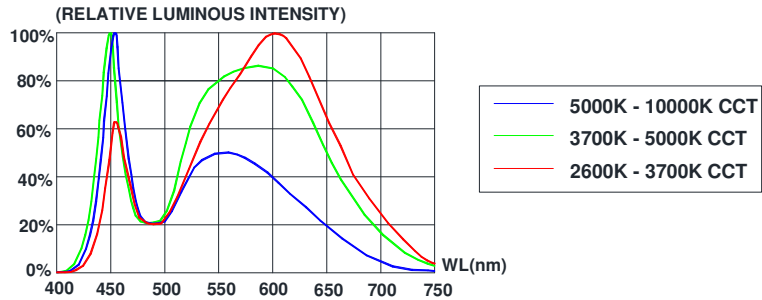

FIG.4 RELATIVE LUMINOUS INTENSITY VS. WAVELENGTH.

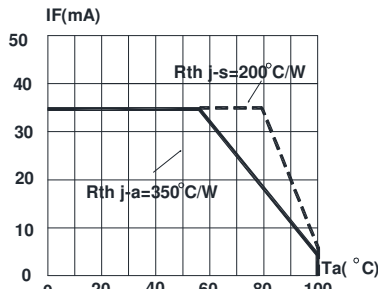

FIG.5 MAXIMUM FORWARD DC CURRENT VS AMBIENT TEMPERATURE (Tjmax=110°C)

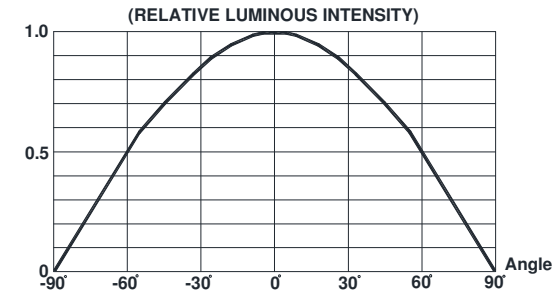
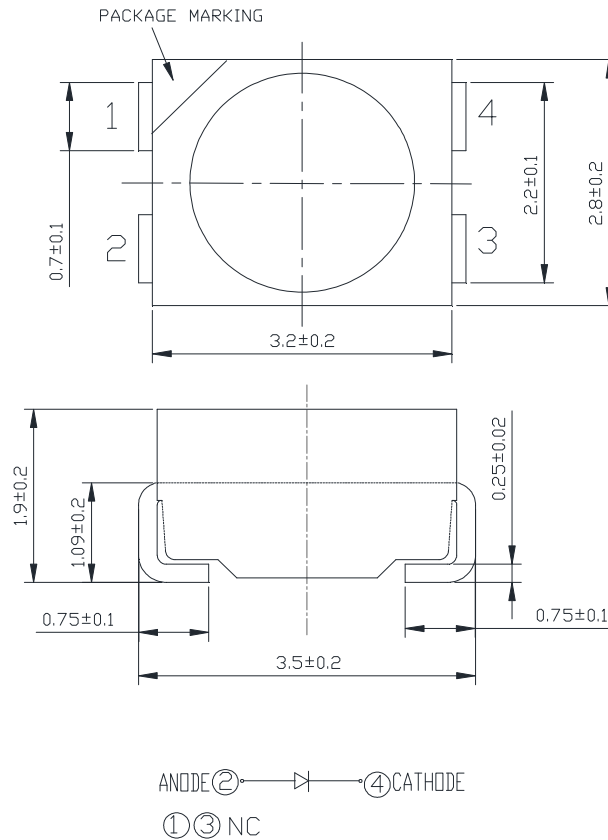

FIG.6 FAR FIELD PATTERN



## MECHANICAL DIMENSIONS

All dimensions are in mm.



## NOTES

### RoHS Compliance

The levels of RoHS restricted materials in this product are below the maximum concentration values (also referred to as the threshold limits) permitted for such substances, or are used in an exempted application, in accordance with EU Directive 2011/65/EC (RoHS2), as implemented January 2, 2013. RoHS Declarations for this product can be obtained from your Cree LED representative or from the [Product Ecology](#) section of the Cree LED website.

### Vision Advisory

WARNING: Do not look at an exposed lamp in operation. Eye injury can result.

## KIT NUMBER SYSTEM

Cree LED lamps are tested and sorted into performance bins. A bin is specified by ranges of color, forward voltage, and brightness. Sorted LEDs are packaged for shipping in various convenient options.

Cree LEDs are sold by order codes in combinations of bins called kits. Order codes are configured in the following manner:

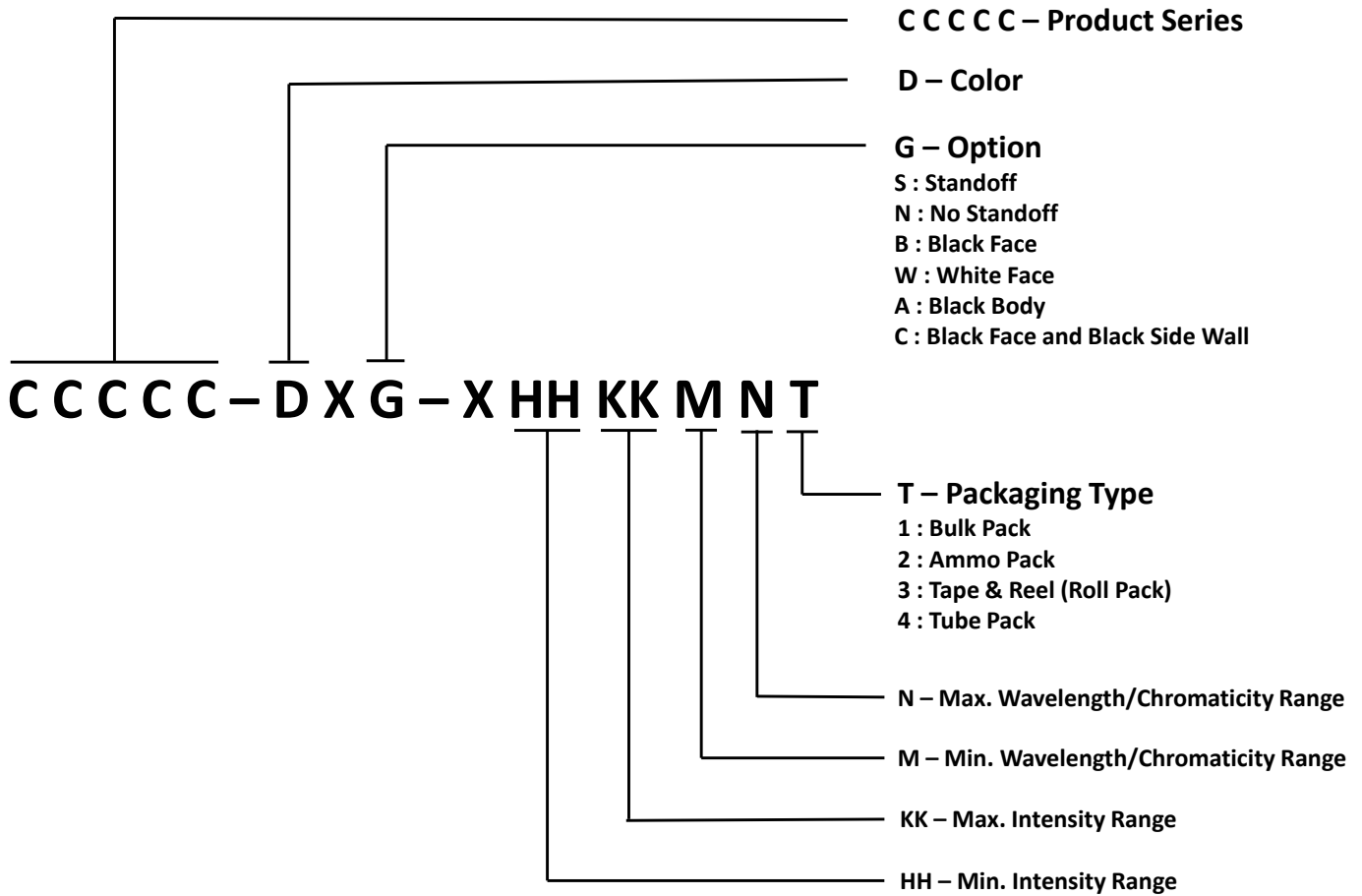

## REFLOW SOLDERING

- The CLA1A-WKW/MKW is rated as a MSL 5a product.
- The recommended floor life out of bag is 24hrs.
- The temperature profile is as below.

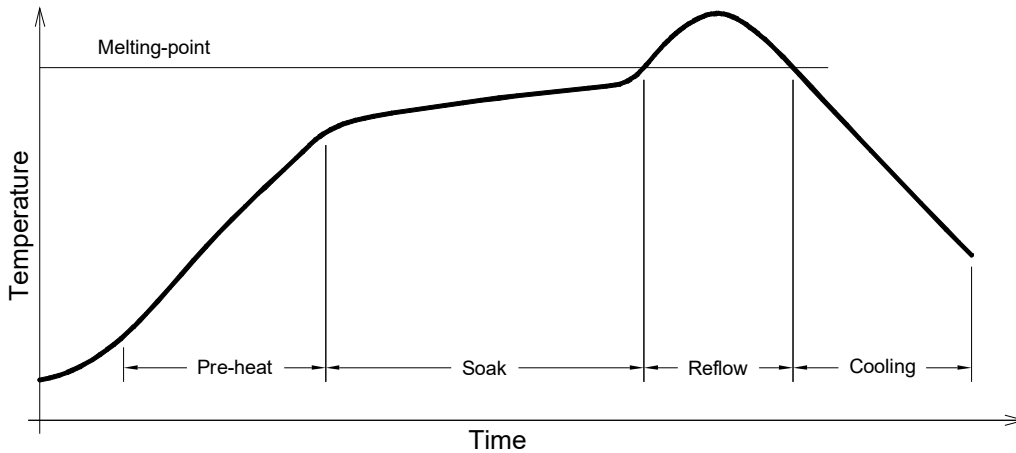

Use only with CLA1A-WKW/MKW

Solder
Average ramp-up rate = 4°C/s max
Preheat temperature = 150°C ~200°C
Preheat time = 120s max
Ramp-down rate = 6°C/s max
Peak temperature = 250°C max
Time within 5°C of actual Peak Temperature = 10s max
Duration above 217°C is 60s max

- The packaging sizes of these SMD products are very small and the resin is still soft after solidification. Users are required to handle with care. Never touch the resin surface of SMD products.
- To avoid damaging the product’s surface and interior device, it is recommended to choose a special nozzle to pick up the SMD products during the process of SMT production. If handling is necessary, take special care when picking up these products. The following method is necessary:
- Please refer to the [HB LED Lamp Soldering & Handling](#) document for information about how to use this LED product safely.

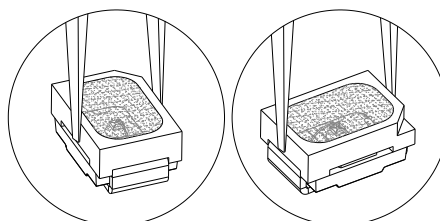



# Mouser Electronics

Authorized Distributor

Click to View Pricing, Inventory, Delivery & Lifecycle Information:

[Cree LED:](#)

[CLA1A-MKW-CWbYa133](#) [CLA1A-WKW-CXaYb153](#) [CLA1A-MKW-CWbYa233](#) [CLA1A-MKW-CWbYa513](#) [CLA1A-MKW-CXaYa233](#) [CLA1A-MKW-CXaYa513](#) [CLA1A-WKW-CXaYb453](#) [CLA1A-WKW-CXbYb453](#)