

## C503D-WAN: 5-mm Round White LED

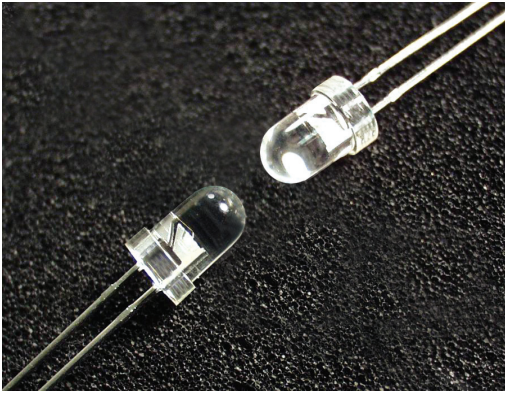

### PRODUCT DESCRIPTION

Round LEDs offer superior light output for excellent readability in sunlight and dependable performance. They provide extremely stable light output over long periods of time.

These lamps are made with an advanced optical grade epoxy offering superior high temperature and high moisture resistance performance in lighting and illumination applications.

### FEATURES

- Size (mm): 5
- Color Temperatures:  
Cool White :  
Min . (4600K) / Typical (9000K)
- Luminous Intensity (mcd)  
C503D-WAN:(28200-64600)
- Viewing angles:  
15°: C503B-WAN
- Lead - Free
- RoHS Compliant

### APPLICATIONS

- Torch
- Channel Letter
- Retail Display Lighting

**ABSOLUTE MAXIMUM RATINGS ( $T_A = 25^\circ\text{C}$ )**

Items	Symbol	Absolute Maximum Rating	Unit
Forward Current	$I_F$	30	mA
Peak Forward Current <sup>Note 1</sup>	$I_{FP}$	100	mA
Reverse Voltage	$V_R$	5	V
Power Dissipation	$P_D$	120	mW
Operation Temperature	$T_{opr}$	-40 ~ +95	$^\circ\text{C}$
Storage Temperature	$T_{stg}$	-40 ~ +100	$^\circ\text{C}$
Lead Soldering Temperature	$T_{sol}$	Max. 260 $^\circ\text{C}$ for 3 sec. max. (3 mm from the base of the epoxy bulb)	

**Note:**

1. Pulse width  $\leq 0.1$  msec, duty  $\leq 1/10$ .

**TYPICAL ELECTRICAL & OPTICAL CHARACTERISTICS ( $T_A = 25^\circ\text{C}$ )**

Characteristics	Symbol	Condition	Unit	Minimum	Typical	Maximum
Forward Voltage	$V_F$	$I_F = 20$ mA	V		3.2	4.0
Reverse Current	$I_R$	$V_R = 5$ V	$\mu\text{A}$			100
Luminous Intensity	$I_v$	$I_F = 20$ mA	mcd	28200	48000	
Chromaticity Coordinates	x	$I_F = 20$ mA			0.2895	
	y	$I_F = 20$ mA			0.2905	
50% Power Angle	$2\theta_{1/2}$	$I_F = 20$ mA	deg		15	

- \* Continuous reverse voltage can cause LED damage.

## INTENSITY BIN LIMIT

Cool White (20 mA) - C503B-WAN		
Bin Code	Min.(mcd)	Max.(mcd)
Cb	28200	32900
Da	32900	39500
Db	39500	46100
Ea	46100	55350
Eb	55350	64600

\* Tolerance of measurement of luminous intensity is  $\pm 15\%$

## VOLTAGE BIN LIMIT

Cool White (20 mA) - C503B-WAN		
Bin Code	Min. (V)	Max. (V)
27	2.8	3.0
28	3.0	3.2
29	3.2	3.4
2a	3.4	3.6
2b	3.6	3.8
2c	3.8	4.0

\* Tolerance of measurement of voltage is  $\pm 0.05V$

COLOR BIN LIMIT

Cool White (20 mA) - C503D-WAN

Bin Code	Sub-bin	x	y
W1	Wa	0.2545	0.2480
		0.2633	0.2410
		0.2545	0.2245
		0.2450	0.2290
	Wb	0.2633	0.2410
		0.2720	0.2340
		0.2640	0.2200
		0.2545	0.2245
	Wc	0.2545	0.2480
		0.2640	0.2670
		0.2720	0.2575
		0.2633	0.2410
	Wd	0.2633	0.2410
		0.2720	0.2575
		0.2800	0.2480
		0.2720	0.2340
W2	We	0.2640	0.2670
		0.2735	0.2860
		0.2808	0.2740
		0.2720	0.2575
	Wf	0.2720	0.2575
		0.2808	0.2740
		0.2880	0.2620
		0.2800	0.2480
	Wg	0.2735	0.2860
		0.2830	0.3050
		0.2895	0.2905
		0.2808	0.2740
	Wh	0.2808	0.2740
		0.2895	0.2905
		0.2960	0.2760
		0.2880	0.2620

Bin Code	Sub-bin	x	y
W3	Wj	0.2830	0.3050
		0.2950	0.3210
		0.2998	0.3028
		0.2895	0.2905
	Wk	0.2895	0.2905
		0.2998	0.3028
		0.3045	0.2865
		0.2960	0.2760
	Wm	0.2950	0.3210
		0.3070	0.3370
		0.3100	0.3150
		0.2998	0.3028
	Wn	0.2998	0.3028
		0.3100	0.3150
		0.3130	0.2970
		0.3045	0.2865
W4	Wp	0.3070	0.3370
		0.3185	0.3485
		0.3200	0.3270
		0.3100	0.3150
	Wq	0.3100	0.3150
		0.3200	0.3270
		0.3215	0.3075
		0.3130	0.2970
	Wr	0.3185	0.3485
		0.3300	0.3600
		0.3300	0.3390
		0.3200	0.3270
	Ws	0.3200	0.3270
		0.3300	0.3390
		0.3300	0.3180
		0.3215	0.3075

Bin Code	Sub-bin	x	y
W5	Wt	0.3300	0.3600
		0.3455	0.3725
		0.3443	0.3535
		0.3300	0.3390
	Wu	0.3300	0.3390
		0.3443	0.3535
		0.3430	0.3345
		0.3300	0.3180
	Wv	0.3455	0.3725
		0.3610	0.3850
		0.3585	0.3680
		0.3443	0.3535
	Ww	0.3443	0.3535
		0.3585	0.3680
		0.3560	0.3510
		0.3430	0.3345

\* Tolerance of measurement of the color coordinates is ±0.01

CIE CHROMATICITY DIAGRAM

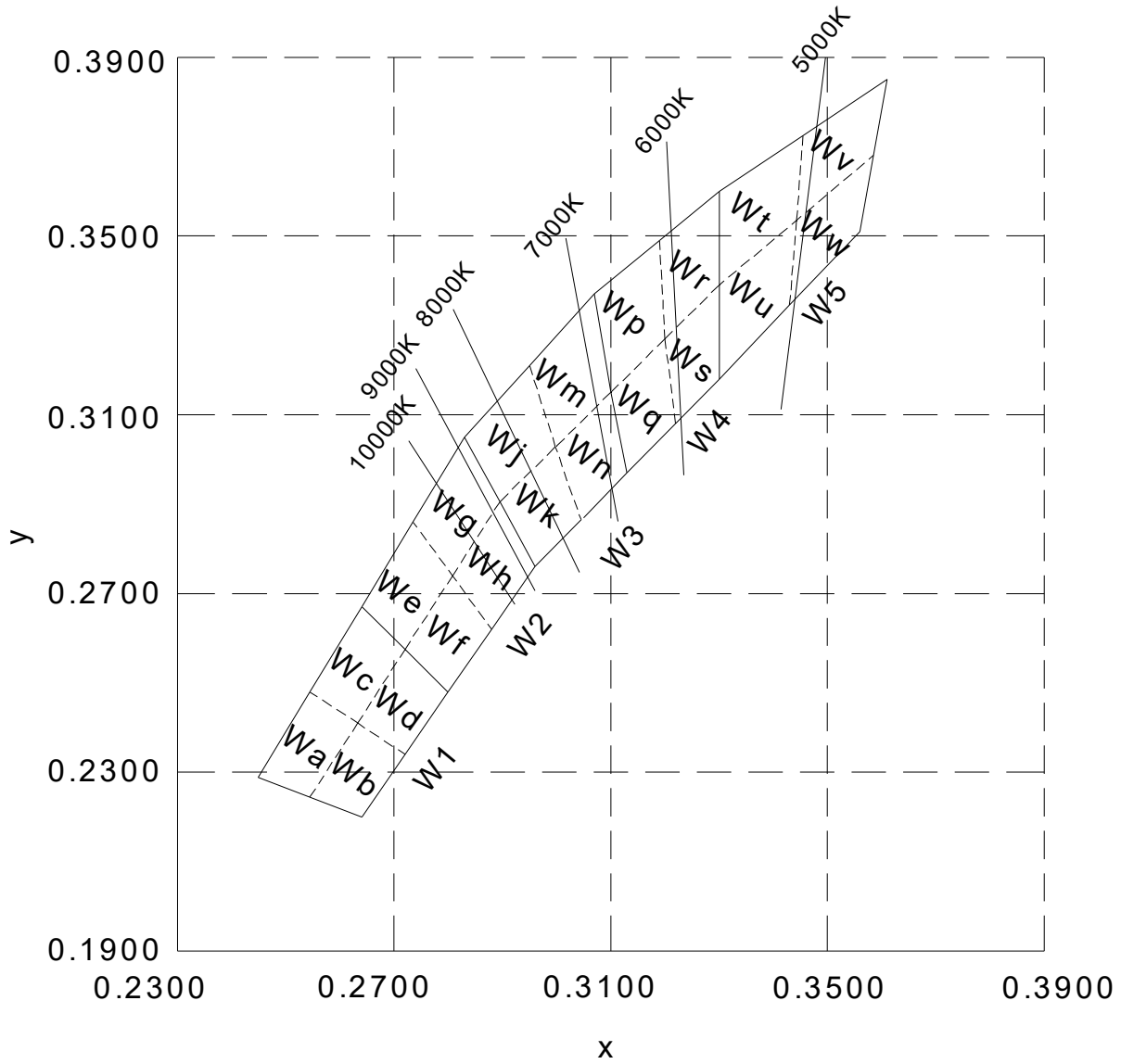

## ORDER CODE TABLE

Color	Viewing Angle	Kit Number	Luminous Intensity (mcd)		Color Bin Code	Package
			Min.	Max.		
Cool White	15°	C503D-WAN-CCbEb151	28200	64600	W1,W2,W3,W4,W5	Bulk
		C503D-WAN-CCbEb231	28200	64600	W2,W3	Bulk
		C503D-WAN-CCbEb152	28200	64600	W1,W2,W3,W4,W5	Ammo
		C503D-WAN-CCbEb232	28200	64600	W2,W3	Ammo

### Notes:

- The above kit numbers represent order codes that include multiple intensity-bin and color-bin codes. Only one intensity-bin code and one color-bin code will be shipped on each bulk. Single intensity-bin code and single color-bin codes will not be orderable.
- Please refer to the [HB LED Lamp Reliability Test Standards](#) document for reliability test conditions.
- Please refer to the [HB LED Lamp Soldering & Handling](#) document for information about how to use this LED product safely.

GRAPHS

The data below are collected from statistical figures that do not necessarily correspond to the actual parameters of each single LED. Hence, these data will be changed without further notice.

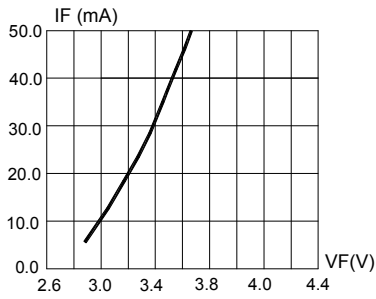

FIG. 1 FORWARD CURRENT VS. FORWARD VOLTAGE.

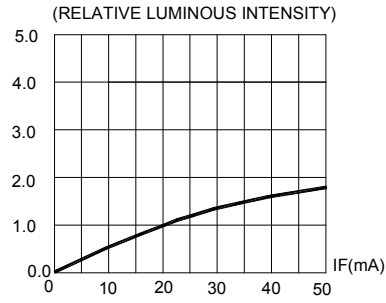

FIG. 2 RELATIVE LUMINOUS INTENSITY VS. FORWARD CURRENT

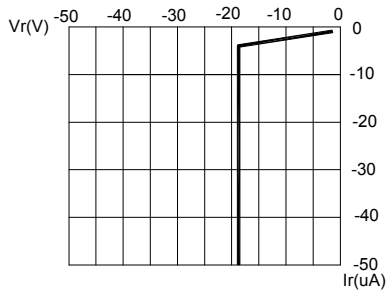

FIG. 3 REVERSE CURRENT VS. REVERSE VOLTAGE.

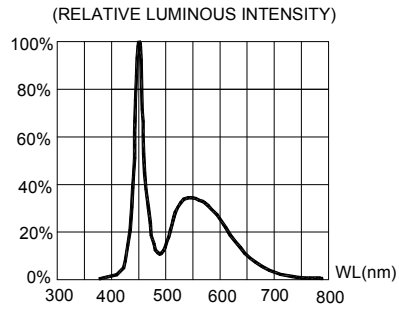

FIG. 4 RELATIVE LUMINOUS INTENSITY VS. WAVELENGTH.

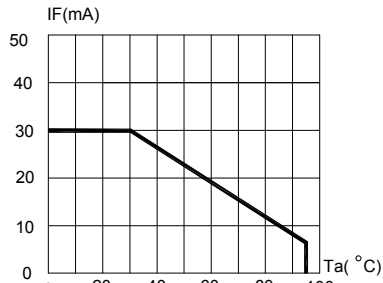

FIG. 5 MAXIMUM FORWARD DC CURRENT VS AMBIENT TEMPERATURE (Tjmax=105°C)

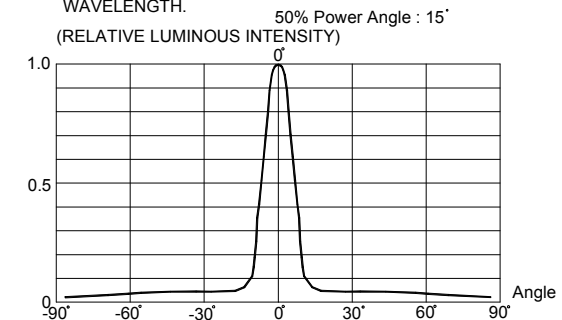

FIG. 6 FAR FIELD PATTERN

## MECHANICAL DIMENSIONS

All dimensions are in mm. Tolerance is  $\pm 0.25$  mm unless otherwise noted.

An epoxy meniscus may extend about 1.5 mm down the leads.

Burr around bottom of epoxy may be 0.5 mm max.

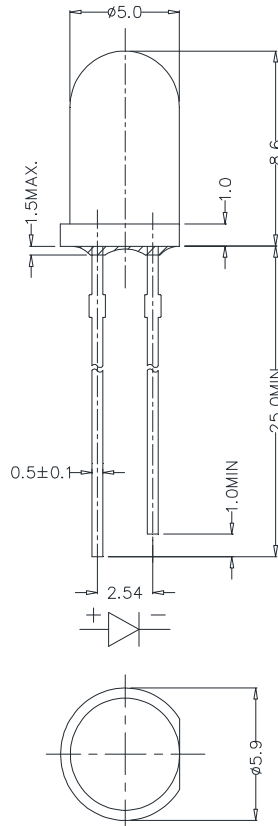

## NOTES

### RoHS Compliance

The levels of RoHS restricted materials in this product are below the maximum concentration values (also referred to as the threshold limits) permitted for such substances, or are used in an exempted application, in accordance with EU Directive 2011/65/EC (RoHS2), as implemented January 2, 2013. RoHS Declarations for this product can be obtained from your Cree LED representative or from the [Product Ecology](#) section of the Cree LED website.

### Vision Advisory

**WARNING:** Do not look at an exposed lamp in operation. Eye injury can result.



**KIT NUMBER SYSTEM**

Cree LED lamps are tested and sorted into performance bins. A bin is specified by ranges of color, forward voltage, and brightness. Sorted LEDs are packaged for shipping in various convenient options.

Cree LEDs are sold by order codes in combinations of bins called kits. Order codes are configured in the following manner:

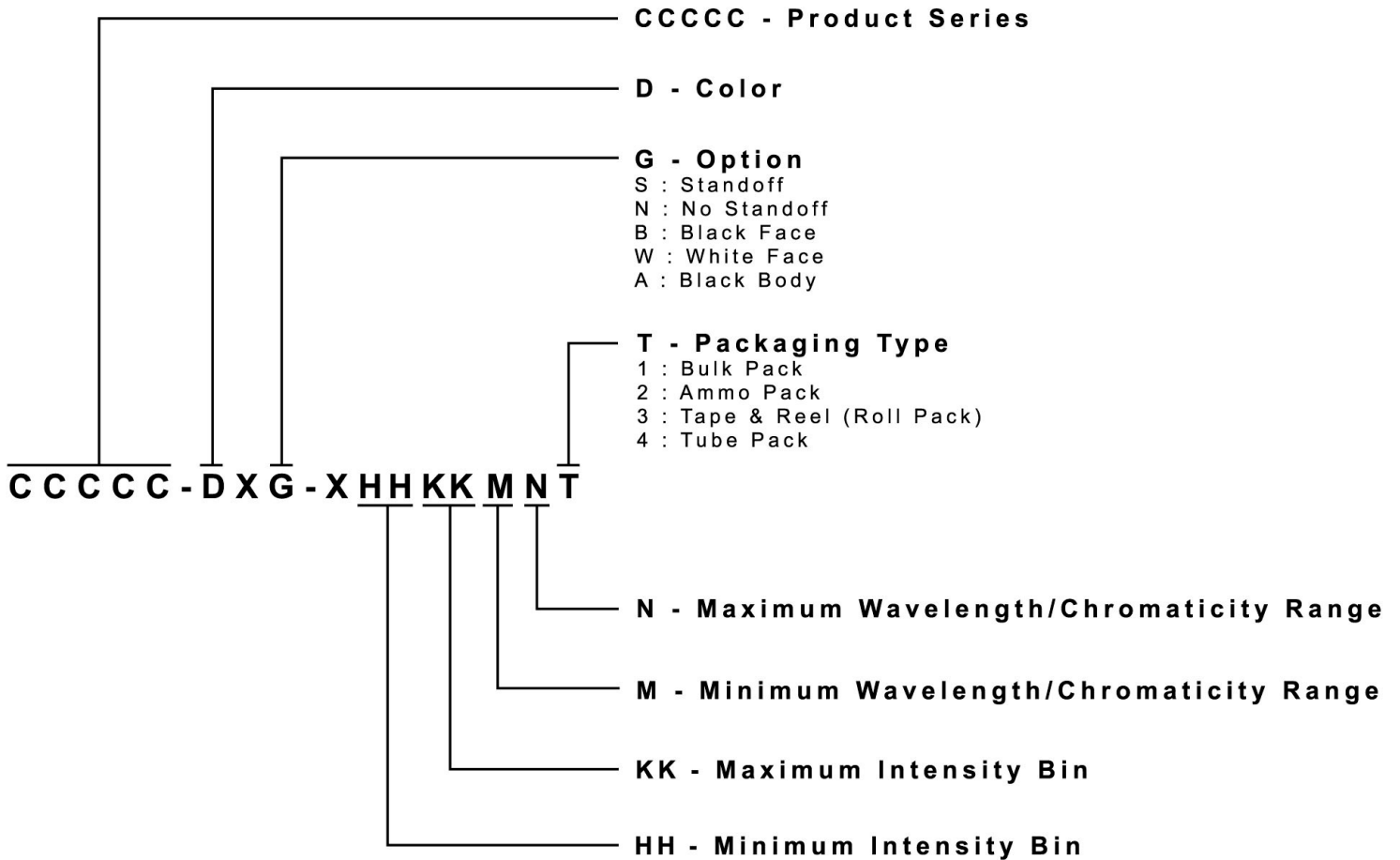

## SOLDERING GUIDELINES

The LED soldering specification is shown below (suitable for both leaded solder & lead-free solder):

Manual Soldering		Solder Dipping	
Soldering iron	35 W max	Preheat	110 °C max
Temperature	300 °C max	Preheat time	60 seconds max
		Solder-bath temperature	260 °C Max
Soldering time	3 seconds max	Dipping time	5 seconds max
Position	Not less than 3 mm from the base of the package.	Position	Not less than 3 mm from the base of the package.

- Manual soldering onto the PCB is not recommended because soldering time is uncontrollable.
- The recommended wave soldering is as below:

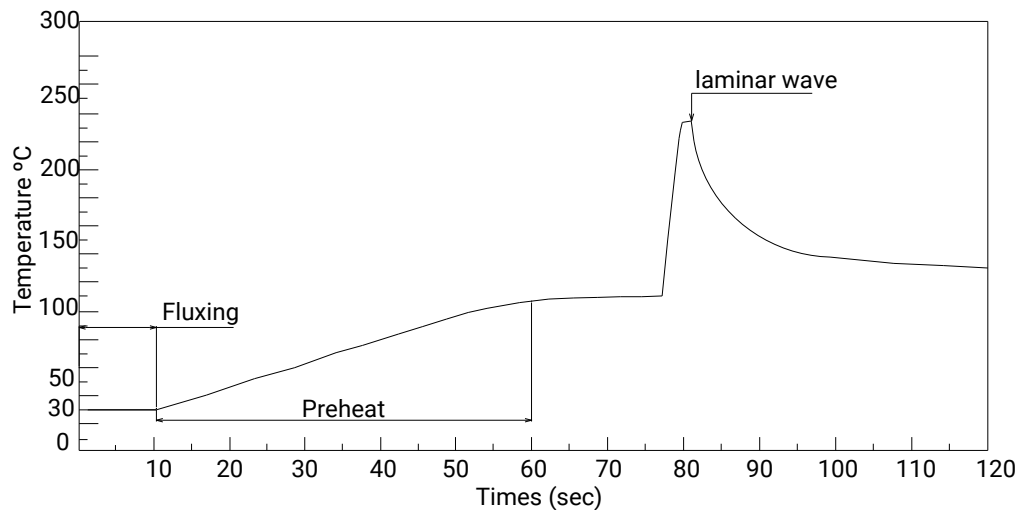

- Do not apply any stress to the LED package, particularly when heated.
- Only bottom preheat is suggested & should not preheat on top in order to reduce thermal stress experienced by the LEDs.
- The LEDs must not be re used once they have been extracted from PCB.
- After soldering the LEDs, the package should be protected from mechanical shock or vibration until the LEDs have reached 40 °C or below.
- Precautions must be taken as mechanical stress on the LEDs may be caused by PCB warpage or from the clinching and cutting of the LED leads.
- When it is necessary to clamp the LEDs during soldering, it is important to ensure no mechanical stress is exerted on the LEDs.
- Cut the LED lead at normal room temperature. Lead cutting at high temperature may cause failure of the LEDs.
- Please refer to the [HB LED Lamp Soldering & Handling](#) document for information about how to use this LED product safely.

## PACKAGING

- The LEDs are packed in cardboard boxes after packaging in normal or anti-electrostatic bags.
- Cardboard boxes will be used to protect the LEDs from mechanical shock during transportation.
- The boxes are not water resistant, and they must be kept away from water and moisture.
- Max 500 pcs per bulk and Max 2500 pcs per ammo.

### Bulk Pack Packaging Type:

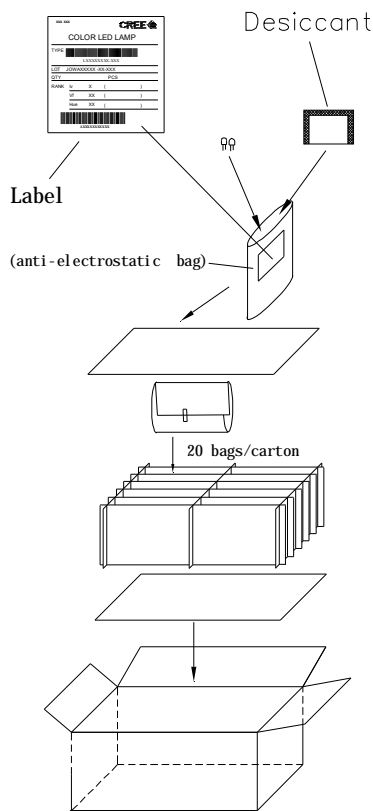

### Ammo Pack Packaging Type:

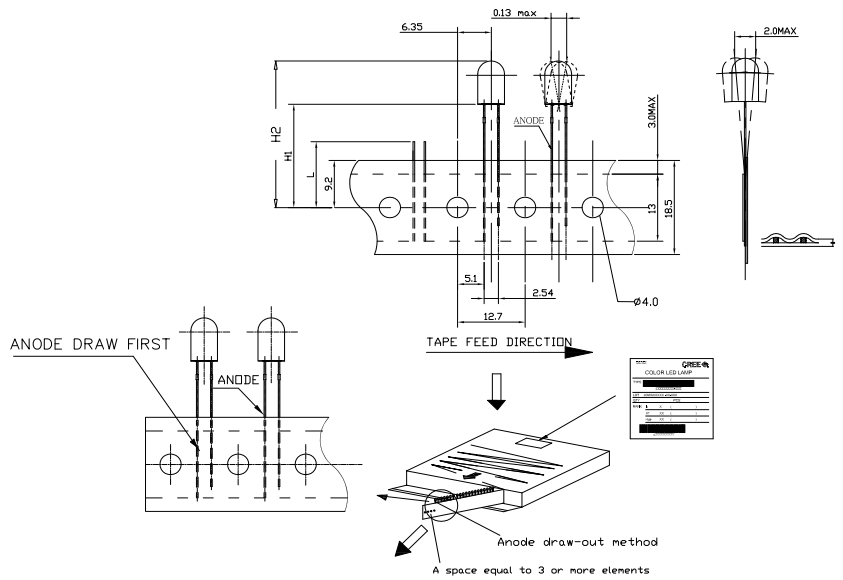

# Mouser Electronics

Authorized Distributor

Click to View Pricing, Inventory, Delivery & Lifecycle Information:

Cree LED:

[C503D-WAN-CCbEb151](#)