

## CLM2D-GPC/BPC: PLCC4 Green & Blue SMD LEDs



### PRODUCT DESCRIPTION

SMD LEDs is packaged in the industry standard package. These LEDs have high reliability performance and are designed to work under a wide range of environmental conditions. This high reliability feature makes them ideally suited to be used in architectural lighting application conditions

Cree LED has been certified in accordance with ISO/IATF16949.

### FEATURES

- Size (mm): 3.2 x 2.8
- Color and Typical Dominant Wavelength:  
Green (520-535nm)  
Blue (465-475nm)
- Viewing angles:  
CLM2D-GPC/BPC  
30 degree minimum
- Moisture Sensitivity Level: 5a
- Lead - Free
- RoHS Compliant
- Untinted Diffused Lens

### APPLICATIONS

- Channel Letter
- Architectural Lighting

**ABSOLUTE MAXIMUM RATINGS ( $T_A = 25^\circ\text{C}$ )**

Items	Symbol	Absolute Maximum Rating		Unit
		Green	Blue	
Forward Current	$I_F$	35		mA
Peak Forward Current <sup>Note1</sup>	$I_{FP}$	100		mA
Reverse Voltage	$V_R$	5		V
Power Dissipation	$P_D$	140		mW
Operation Temperature	$T_{opr}$	-40 ~ +100		$^\circ\text{C}$
Storage Temperature	$T_{stg}$	-40 ~ +100		$^\circ\text{C}$
Junction Temperature	$T_J$	110		$^\circ\text{C}$
Junction/Ambient	$R_{THJA}$	450	320	$^\circ\text{C}/\text{W}$
Junction/Solder Point	$R_{THJS}$	220	150	$^\circ\text{C}/\text{W}$
Electrostatic Discharge Classification(MIL-STD-883E)	ESD	1000V		

**Note:**

1. Pulse width  $\leq 0.1$  msec, duty  $\leq 1/10$ .

**TYPICAL ELECTRICAL & OPTICAL CHARACTERISTICS ( $T_A = 25^\circ\text{C}$ )**

Characteristics	Color	Symbol	Condition	Unit	Minimum	Typical	Maximum
Forward Voltage	Green	$V_F$	$I_F = 20$ mA	V		2.9	4.0
	Blue	$V_F$	$I_F = 20$ mA	V		3.1	4.0
Reverse Current	Green/Blue	$I_R$	$V_R = 5$ V	$\mu\text{A}$			10
Dominant Wavelength	Green	$\lambda_D$	$I_F = 20$ mA	nm	520	527.5	535
	Blue	$\lambda_D$	$I_F = 20$ mA	nm	465	470	475
Luminous Intensity	Green	$I_V$	$I_F = 20$ mA	mcd	5600	10000	
	Blue	$I_V$	$I_F = 20$ mA	mcd	1120	2000	
50% Power Angle	Green/Blue	$2\theta_{1/2}$	$I_F = 20$ mA	deg	30		

- \* Continuous reverse voltage can cause LED damage.

## INTENSITY BIN LIMIT

Green (20 mA)			Blue (20 mA)		
Bin Code	Min.(mcd)	Max.(mcd)	Bin Code	Min.(mcd)	Max.(mcd)
A0	5600	7100	Wa	1120	1400
B0	7100	9000	Wb	1400	1800
C0	9000	11200	Xa	1800	2240
D0	11200	14000	Xb	2240	2800
E0	14000	18000	Ya	2800	3550

\* Tolerance of measurement of luminous intensity is  $\pm 10\%$

## COLOR BIN LIMIT

Green (20 mA)			Blue (20 mA)		
Bin Code	Min.(nm)	Max.(nm)	Bin Code	Min.(nm)	Max.(nm)
G7	520	525	B4	465	470
G23	522.5	527.5	B45	467.5	472.5
G8	525	530	B5	470	475
G45	527.5	532.5			
G9	530	535			

\* Tolerance of measurement of dominant wavelength is  $\pm 1$  nm.

## ORDER CODE TABLE

Color	Kit Number	Luminous Intensity (mcd)		Dominant Wavelength				Package
		Min.	Max.	Color Bin	Min.(nm)	Color Bin	Max.(nm)	
Green	CLM2D-GPC-CA0E0793	5600	18000	G7	520	G9	535	Reel
	CLM2D-GPC-CB0E0793	7100	18000	G7	520	G9	535	Reel
	CLM2D-GPC-CB0E0783	7100	18000	G7	520	G8	530	Reel
Blue	CLM2D-BPC-CWaYa453	1120	3550	B4	465	B5	475	Reel
	CLM2D-BPC-CWbYa453	1400	3550	B4	465	B5	475	Reel

### Notes:

- The above kit numbers represent order codes that include multiple intensity-bin and color-bin codes. Only one intensity-bin code and one color-bin code will be shipped on each bulk. Single intensity-bin code and single color-bin codes will not be orderable.
- Please refer to the [HB LED Lamp Reliability Test Standards](#) document for reliability test conditions.
- Please refer to the [HB LED Lamp Soldering & Handling](#) document for information about how to use this LED product safely.

GRAPHS

The data below are collected from statistical figures that do not necessarily correspond to the actual parameters of each single LED. Hence, these data will be changed without further notice.

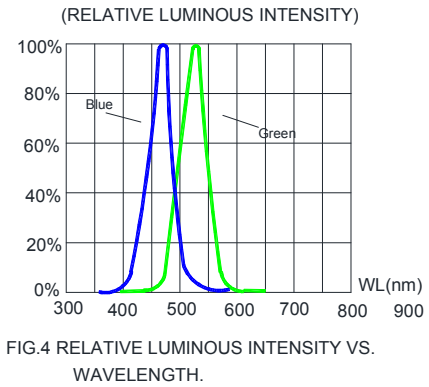
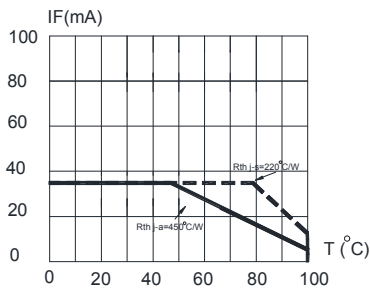
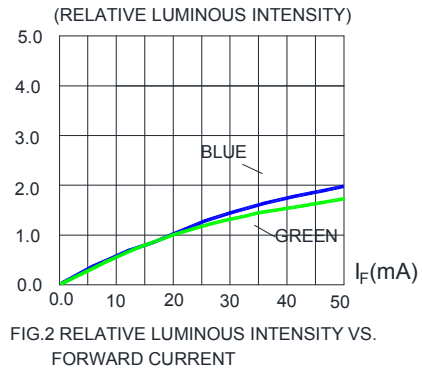
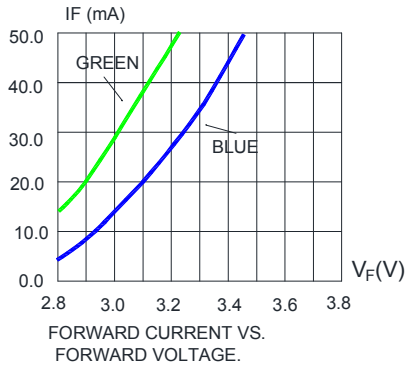

FIG.5 Green MAXIMUM FORWARD DC CURRENT VS AMBIENT TEMPERATURE (Tjmax=110°C)

FIG.4 RELATIVE LUMINOUS INTENSITY VS. WAVELENGTH.

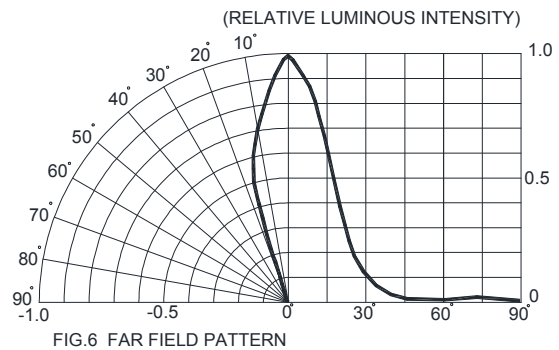
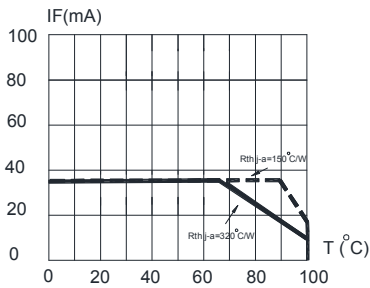
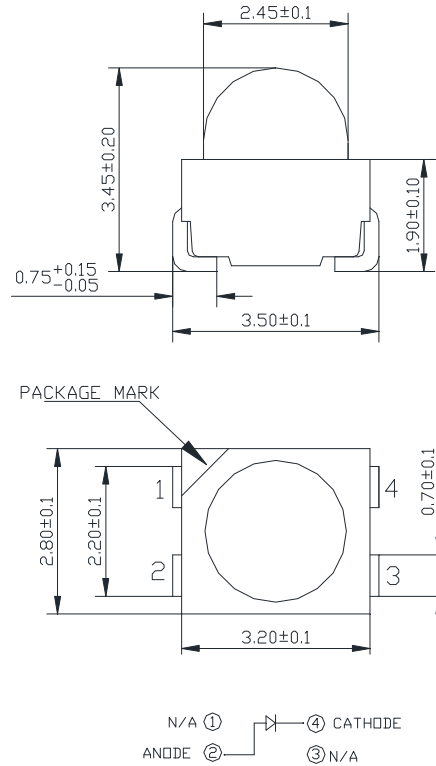

FIG.5 Blue MAXIMUM FORWARD DC CURRENT VS AMBIENT TEMPERATURE (Tjmax=110°C)

FIG.6 FAR FIELD PATTERN

## MECHANICAL DIMENSIONS

All dimensions are in mm.



## NOTES

### RoHS Compliance

The levels of RoHS restricted materials in this product are below the maximum concentration values (also referred to as the threshold limits) permitted for such substances, or are used in an exempted application, in accordance with EU Directive 2011/65/EC (RoHS2), as implemented January 2, 2013. RoHS Declarations for this product can be obtained from your Cree LED representative or from the [Product Ecology](#) section of the Cree LED website.

### Vision Advisory

WARNING: Do not look at an exposed lamp in operation. Eye injury can result.

## KIT NUMBER SYSTEM

Cree LED lamps are tested and sorted into performance bins. A bin is specified by ranges of color, forward voltage, and brightness. Sorted LEDs are packaged for shipping in various convenient options.

Cree LEDs are sold by order codes in combinations of bins called kits. Order codes are configured in the following manner:



## REFLOW SOLDERING

- The CLM2D-GPC/BPC is rated as a MSL 5a product.
- The recommended floor life out of bag is 24hrs.
- The temperature profile is as below.

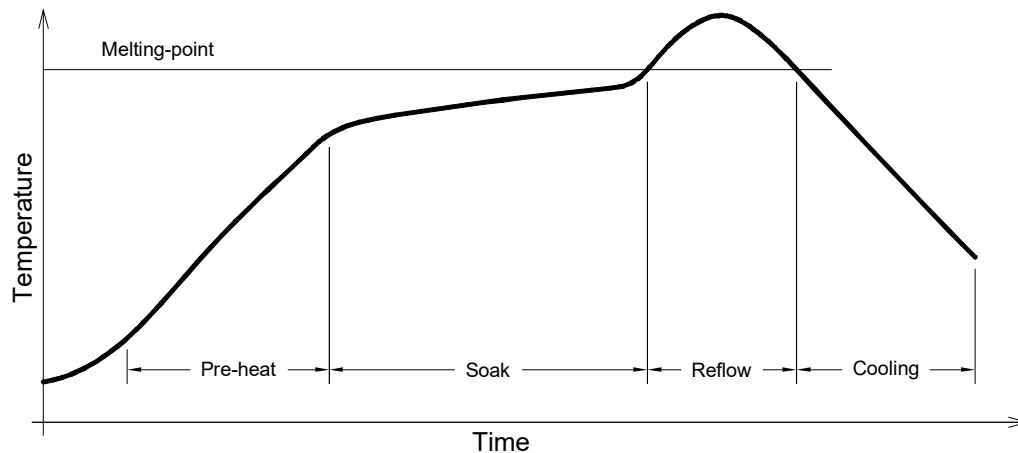

Use only with CLM2D-GPC/BPC

Solder
Average ramp-up rate = 4°C/s max
Preheat temperature = 150°C ~200°C
Preheat time = 120s max
Ramp-down rate = 6°C/s max
Peak temperature = 235°C max
Time within 5°C of actual Peak Temperature = 10s max
Duration above 217°C is 45s max

- The packaging sizes of these SMD products are very small and the resin is still soft after solidification. Users are required to handle with care. Never touch the resin surface of SMD products.
- To avoid damaging the product's surface and interior device, it is recommended to choose a special nozzle to pick up the SMD products during the process of SMT production. If handling is necessary, take special care when picking up these products. The following method is necessary:
- Please refer to the [HB LED Lamp Soldering & Handling](#) document for information about how to use this LED product safely.

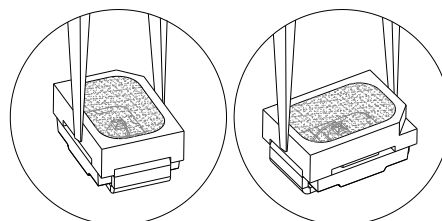



## PACKAGING

- The LEDs are packed in cardboard boxes after packaging in normal or anti-electrostatic bags.
- Cardboard boxes will be used to protect the LEDs from mechanical shock during transportation.
- The boxes are not water resistant, and they must be kept away from water and moisture.
- The reel pack is applied in SMD LED.
- Max 2300 pcs per reel.

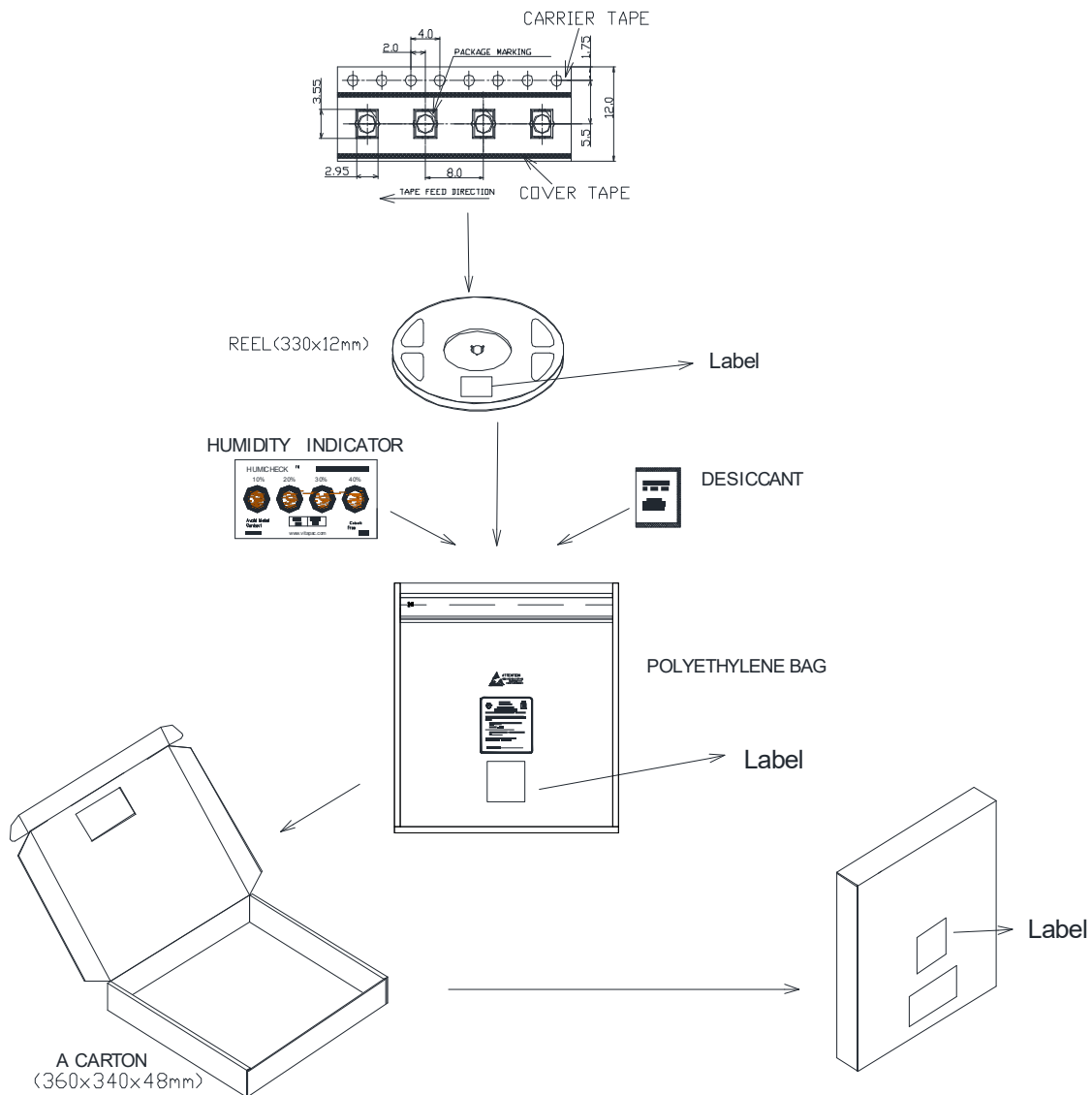

# Mouser Electronics

Authorized Distributor

Click to View Pricing, Inventory, Delivery & Lifecycle Information:

[Cree LED:](#)

[CLM2D-BPC-CWAYA453](#) [CLM2D-GPC-CB0E0783](#) [CLM2D-GPC-CB0E0793](#) [CLM2D-BPC-CWBYA453](#) [CLM2D-GPC-CA0E0793](#)