



**CML**

**INNOVATIVE TECHNOLOGIES, INC.**

**WHERE INNOVATION COMES TO LIGHT**

Americas

147 Central Avenue  
Hackensack, NJ 07601  
(201) 489-8989  
[www.cml-it.com](http://www.cml-it.com)

Europe

Robert Bunsen Str. 1  
D-67098 Bad Durkheim  
+49 (6322) 9567-0  
[www.cml-it.com](http://www.cml-it.com)

---

## *CMDA51xx15D13L Series Power LED (5 Watt)*

### **- Features**

- Super high flux output and high luminance
- Designed for high current operation
- Low thermal resistance
- SMT solder compatible
- Lead (Pb) Free Product – RoHS Compliant

### **- Applications**

- General Illumination
  - Outdoor & Indoor Architectural Lighting
  - Decorative Lighting
  - Portable Lighting / Flash Light (Torch) Lamps
  - Reading Lamps and Task Lighting
  - Traffic Signaling

### **- Description**

These packaged LED's are designed for high current operation and high flux output applications. The package design features better thermal management characteristics than other LED solutions. Because of these advantages, this product has many applications such as internal & external lighting, automobile lighting, large size LCD backlight, etc.



Americas  
147 Central Avenue  
Hackensack, NJ 07601  
(201) 489-8989  
[www.cml-it.com](http://www.cml-it.com)

Europe  
Robert Bunsen Str. 1  
D-67098 Bad Durkheim  
+49 (6322) 9567-0  
[www.cml-it.com](http://www.cml-it.com)

## 1. Outline Dimensions

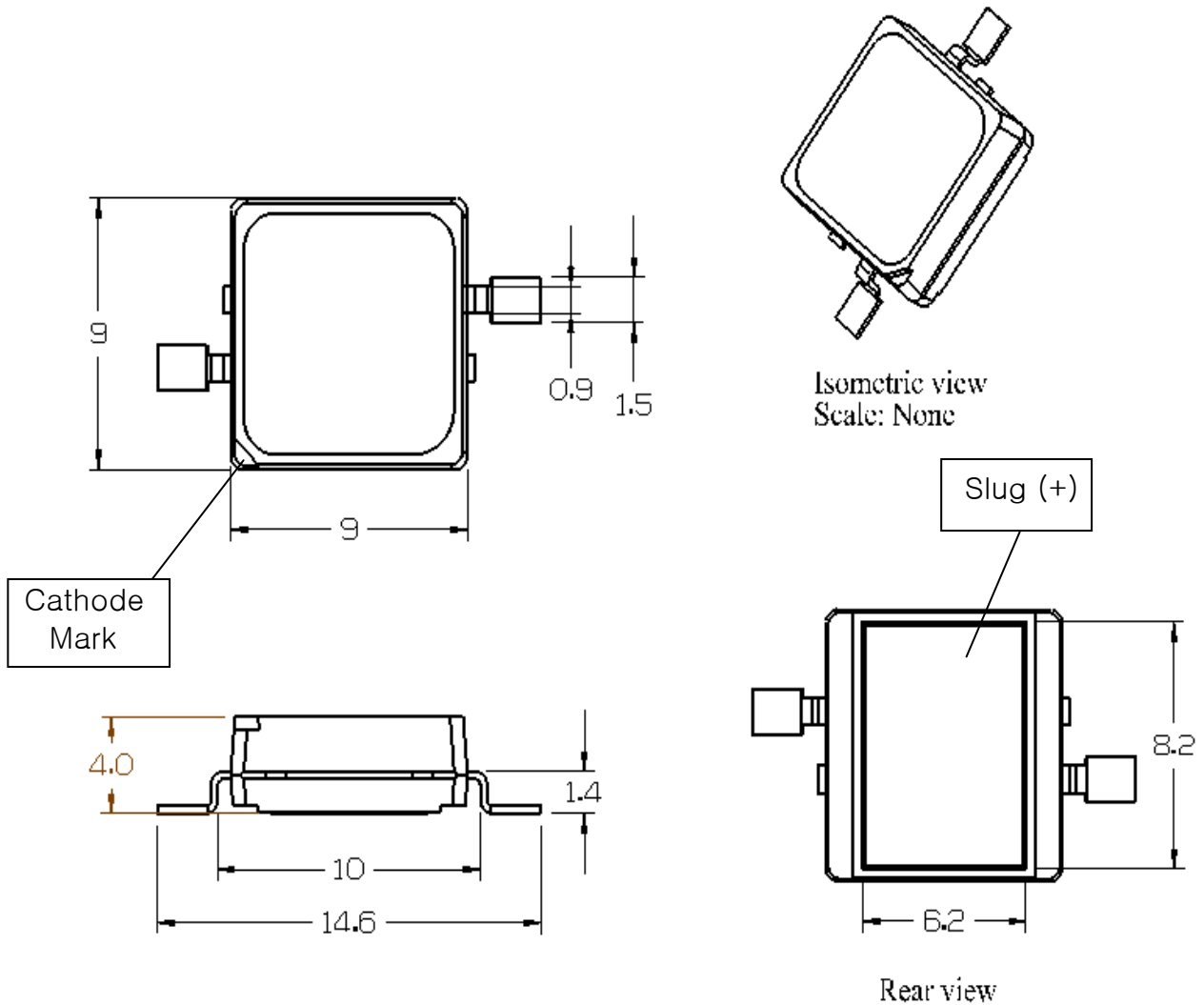

- Notes :
1. All dimensions are in millimeters.
  2. Scale : none
  3. This drawing is reference only for engineering

**CML****INNOVATIVE TECHNOLOGIES, INC.**  
**WHERE INNOVATION COMES TO LIGHT**Americas147 Central Avenue  
Hackensack, NJ 07601  
(201) 489-8989  
www.cml-it.comEuropeRobert Bunsen Str. 1  
D-67098 Bad Durkheim  
+49 (6322) 9567-0  
www.cml-it.com**2. Electro-Optical Characteristics (at IF=1400mA, TA=25°C)**

P/N	Description	Luminous Flux Min./Typ. (lm)	Correlated Color Temperature (Kelvin)	CRI	Dominant Wavelength (nm) Min./Typ./Max.	Forward Voltage (volts) Min./Typ./Max.	View Angle (degrees)	Thermal resistance (°C /W)
	Symbol	$\Phi_V$ [1]	CCT [3]	Ra	$\lambda_D$	V	2 $\theta$ 1/2	R $\theta$ [4]
CMDA51CW15D13L	Pure White	154 / 178	6500	70		3.0 / 3.5 / 4.0	110	4
CMDA51WW15D13L	Warm White	91 / 120	3000	80		3.0 / 3.5 / 4.0	110	4
CMDA51CB15D13L	Blue	24 / 30			455 / 460 / 475	3.0 / 3.5 / 4.0	130	4
CMDA51AG15D13L	Green	118 / 189			520 / 527 / 535	3.0 / 3.5 / 4.0	130	4
CMDA51AR15D13L	Red	91 / 114			620 / 625 / 630	2.0 / 2.5 / 3.0	128	6
CMDA51GB15D13L	Cyan	118 / 150			500 / 505 / 510	3.0 / 3.5 / 4.0	130	4
CMDA51DY15D13L	Amber	118 / 144			585 / 590 / 595	2.0 / 2.5 / 3.0	128	6

**3. Absolute Maximum Ratings (at TA=25°C)**

P/N	Description	Forward Current (A)	Power Dissipation (Watts)	Junction Temperature (°C)	Operating Temperature (°C)	Storage Temperature (°C)
	Symbol	I <sub>F</sub>	P <sub>D</sub>	T <sub>J</sub>	T <sub>opr</sub>	T <sub>stg</sub>
CMDA51CW15D13L	Pure White	1.6	6.4	125	-30~+85	-40~+120
CMDA51WW15D13L	Warm White	1.6	6.4	125	-30~+85	-40~+120
CMDA51CB15D13L	Blue	1.6	6.4	125	-30~+85	-40~+120
CMDA51AG15D13L	Green	1.6	6.4	125	-30~+85	-40~+120
CMDA51AR15D13L	Red	1.6	4.8	100	-30~+85	-40~+120
CMDA51GB15D13L	Cyan	1.6	6.4	125	-30~+85	-40~+120
CMDA51DY15D13L	Amber	1.6	4.8	100	-30~+85	-40~+120

**\*Notes:**

- [1]  $\Phi_V$  is the total luminous flux output as measured with an integrating sphere.  
 [2] Zener diode chip included to protect the LED from ESD.  
 [3] R $\theta$  is measured with a metal core PCB (25 °C ≤ T<sub>J</sub> ≤ 125 °C).  
 [4] CML maintains a tolerance of ± 10% on flux and power measurements.  
 [5] CCT ± 5% tester tolerance.  
 [6] Color Coordinate Measurement allowance is ± 0.005  
 [7] A tolerance of ± 0.006V on forward voltage measurements

**-----Caution-----****Please do not drive at rated current more than 5 sec. without proper heat sink**

#### 4. Forward Voltage vs. Forward Current (Ta=25°C)

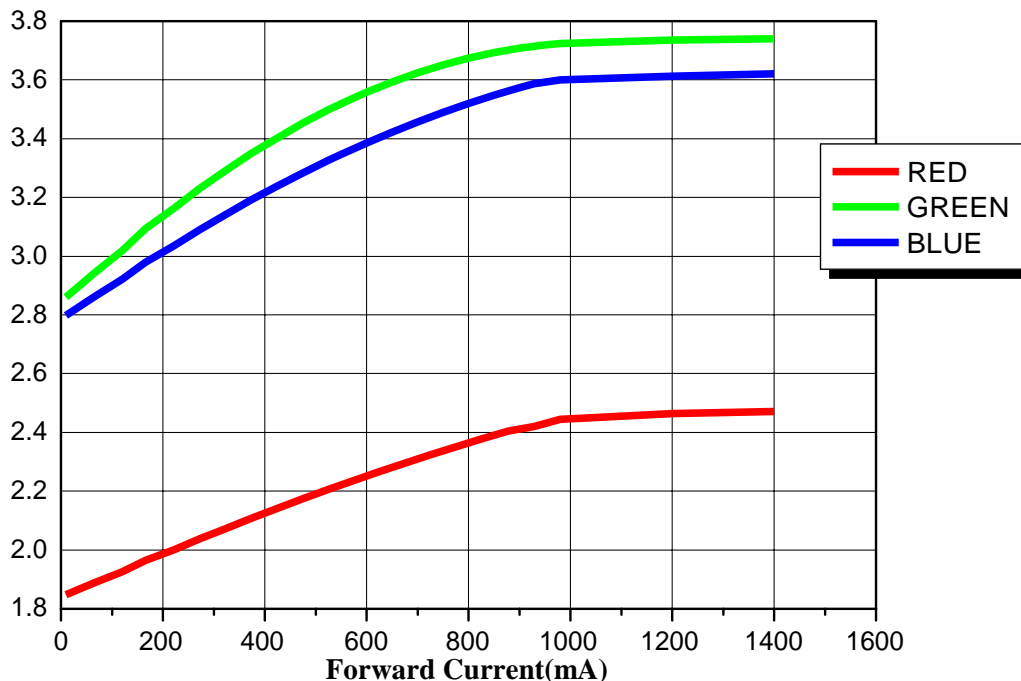

#### 5. Forward Current vs. Normalized Relative Luminous Flux (Ta=25°C)

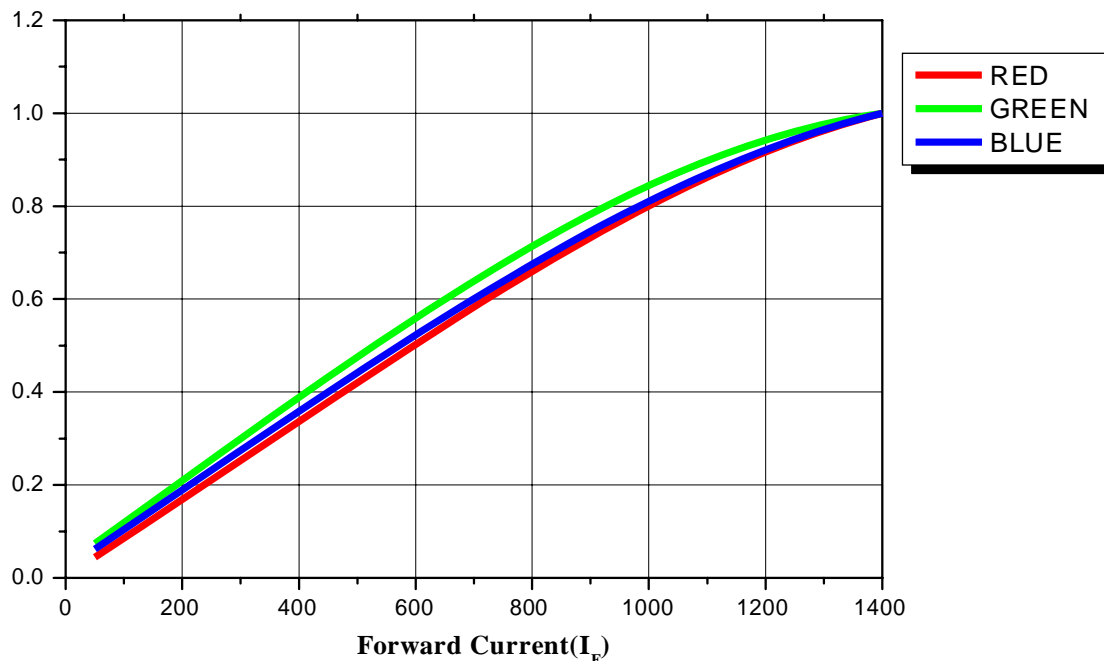

## 6. White Color spectrum of Typical CCT ( $T_a=25^\circ\text{C}$ )

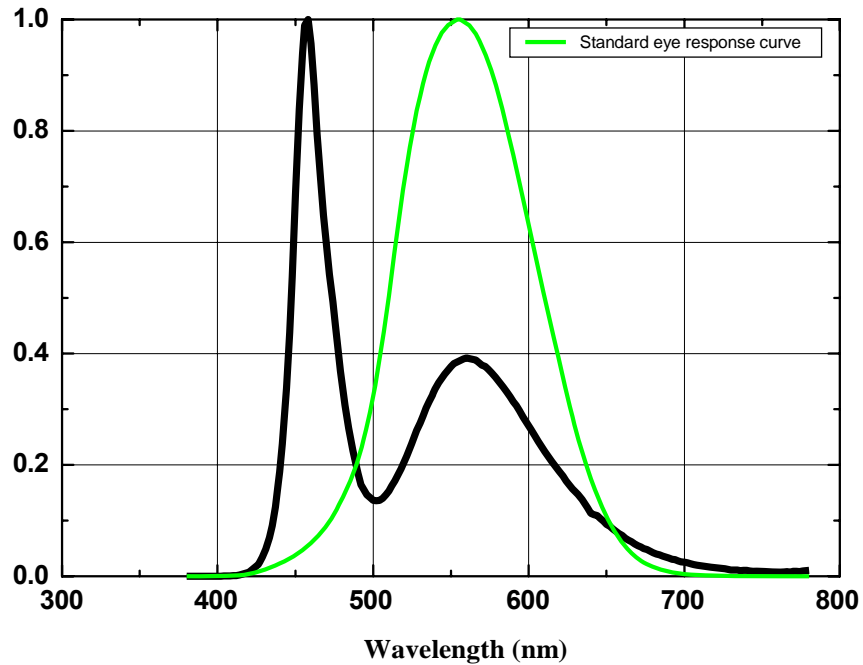

## 7. Warm White spectrum of Typical CCT ( $T_a=25^\circ\text{C}$ )

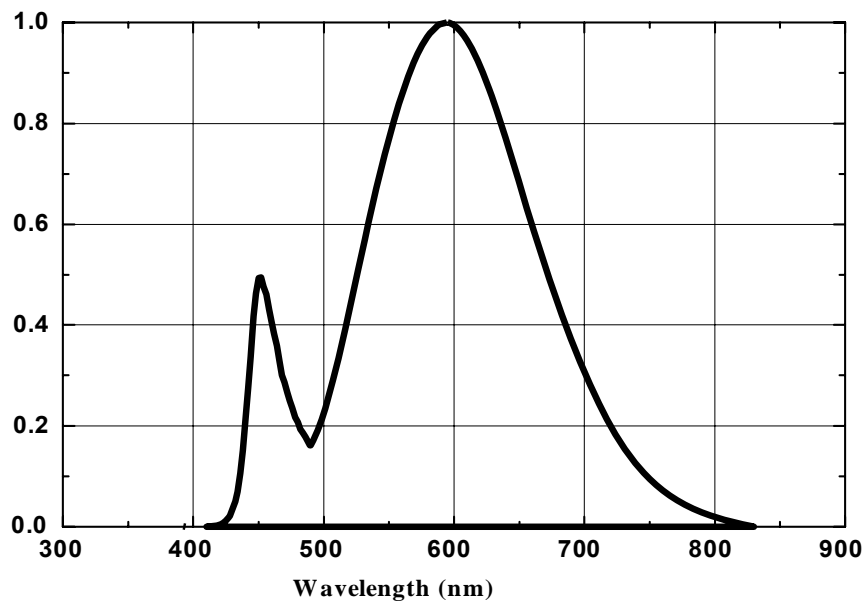

## 8. Spectrum for Red, Green, Blue, Amber, Cyan (Ta=25 °C)

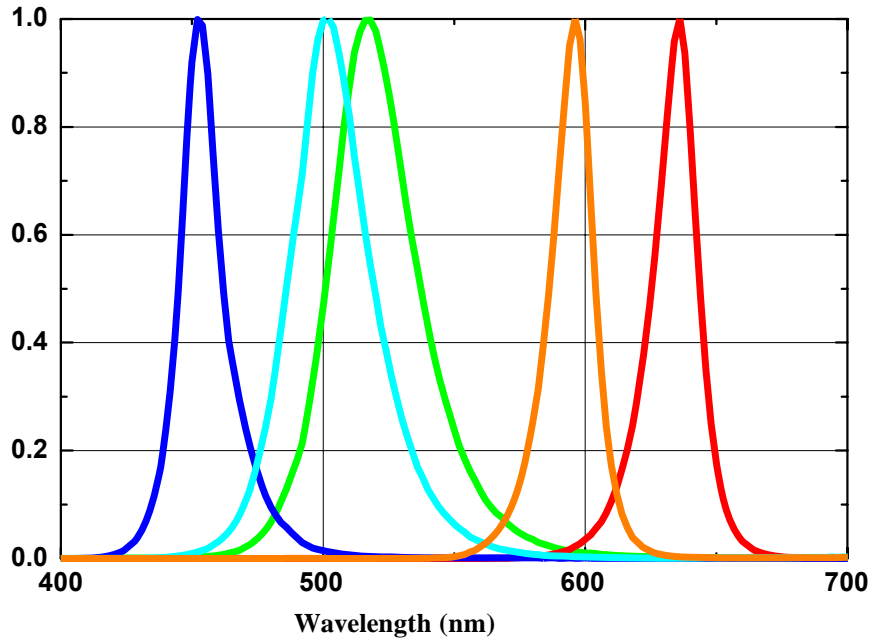

Americas  
147 Central Avenue  
Hackensack, NJ 07601  
(201) 489-8989  
[www.cml-it.com](http://www.cml-it.com)

Europe  
Robert Bunsen Str. 1  
D-67098 Bad Dürkheim  
+49 (6322) 9567-0  
[www.cml-it.com](http://www.cml-it.com)

### 9. Radiation pattern for White

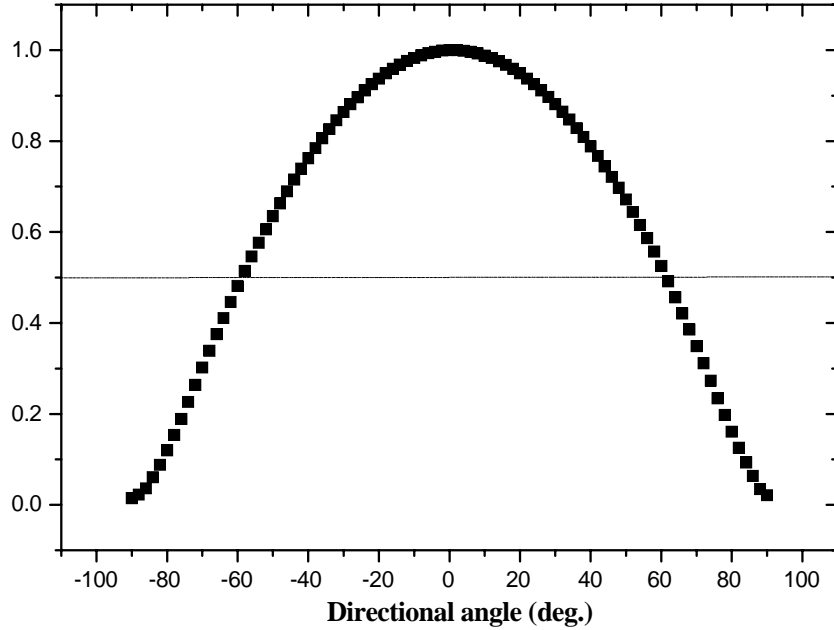

### 10. Radiation pattern for Red

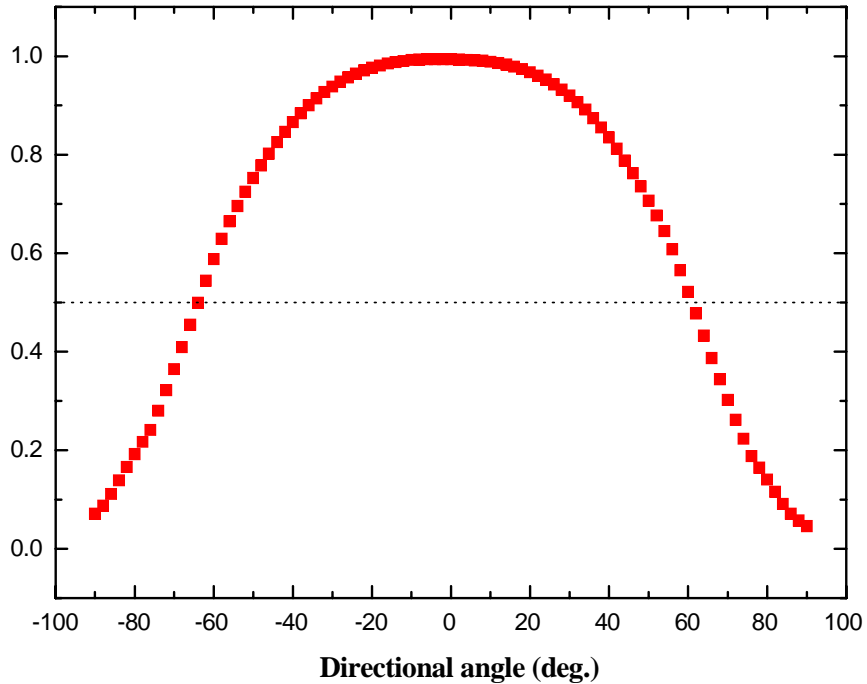

### 11. Radiation pattern for Green

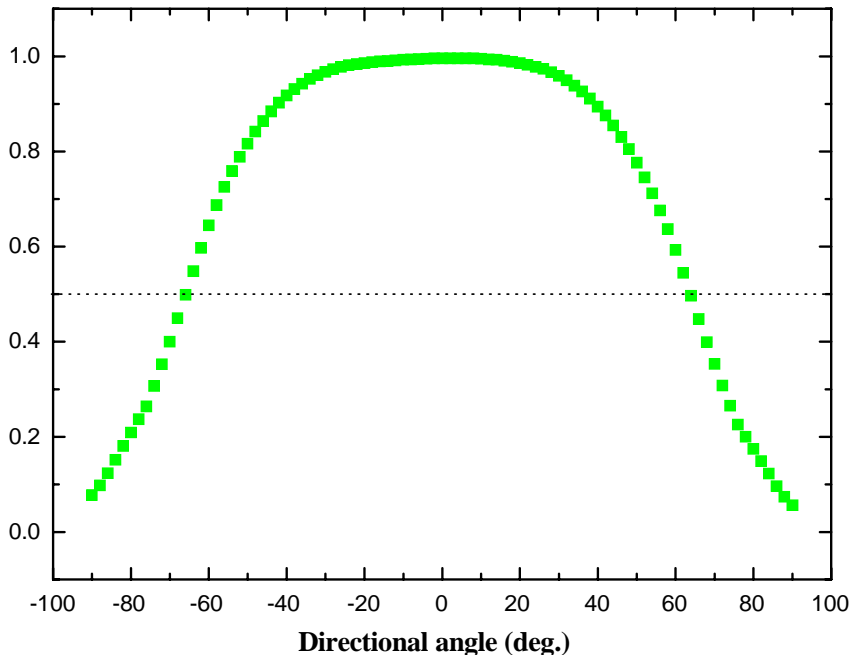

### 12. Radiation pattern for Blue

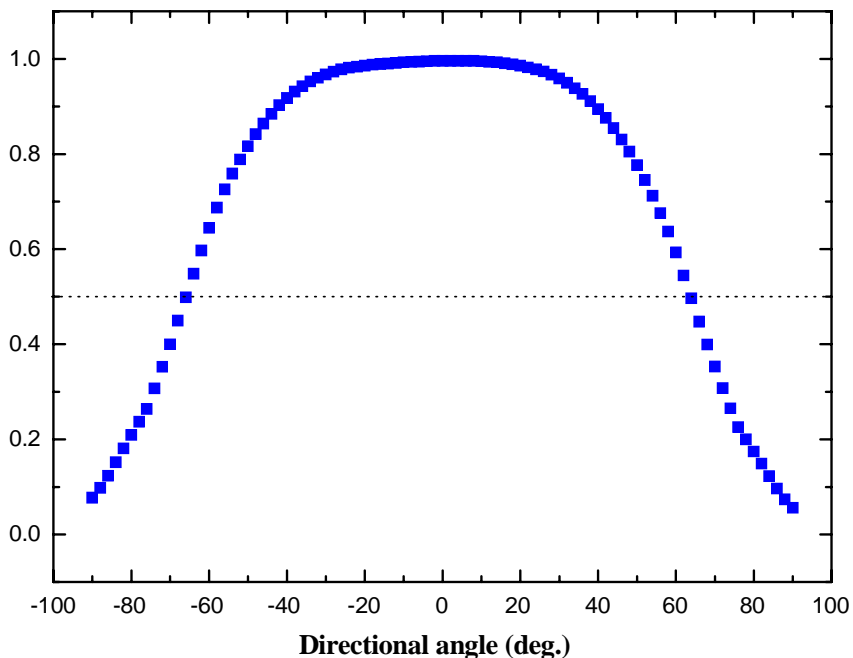

Americas  
147 Central Avenue  
Hackensack, NJ 07601  
(201) 489-8989  
[www.cml-it.com](http://www.cml-it.com)

Europe  
Robert Bunsen Str. 1  
D-67098 Bad Dürkheim  
+49 (6322) 9567-0  
[www.cml-it.com](http://www.cml-it.com)



### 13. Radiation pattern for Cyan

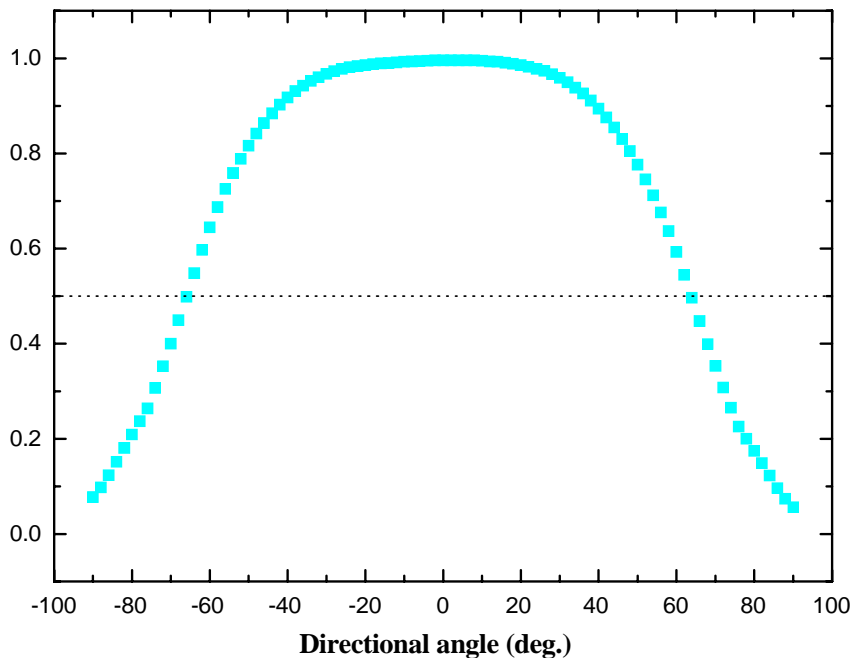

### 14. Radiation pattern for Amber

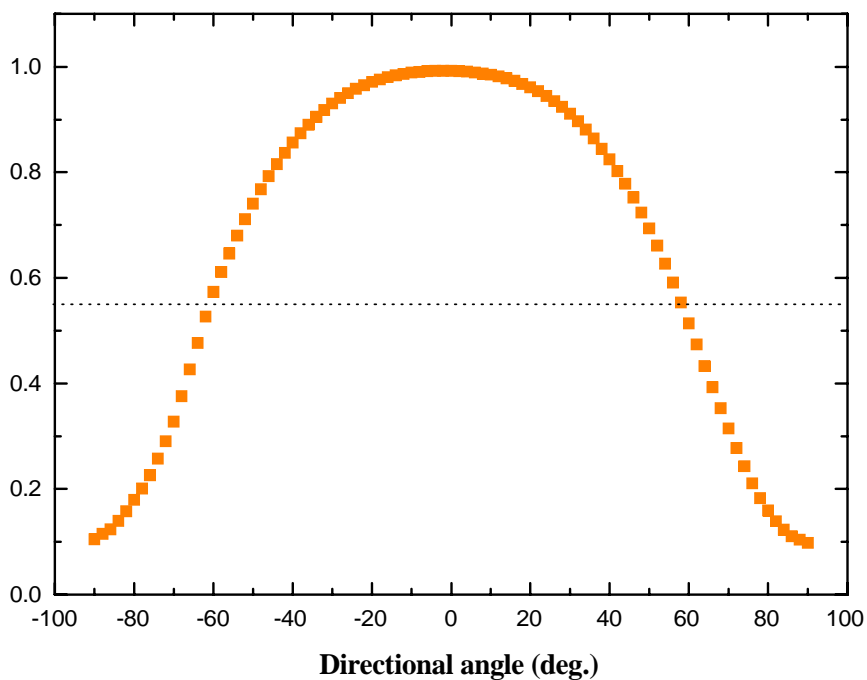

**15. Forward Current vs. Wavelength shift (Ta=25°C)**

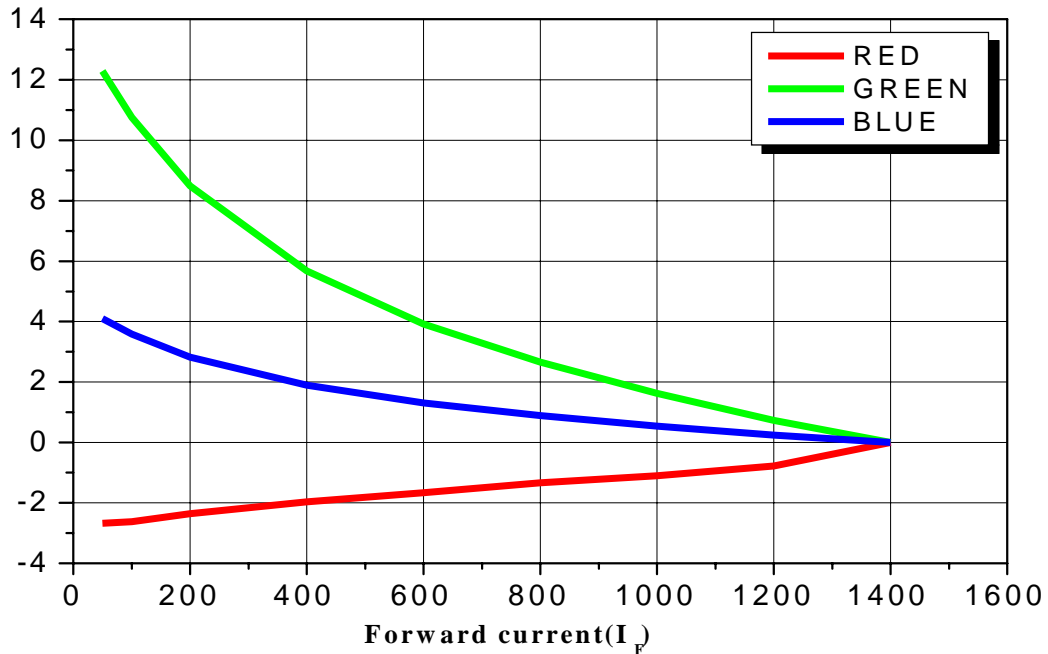

**16. Temperature of Junction vs. Relative Light Output for Blue, Green, Red (Ta=25°C)**

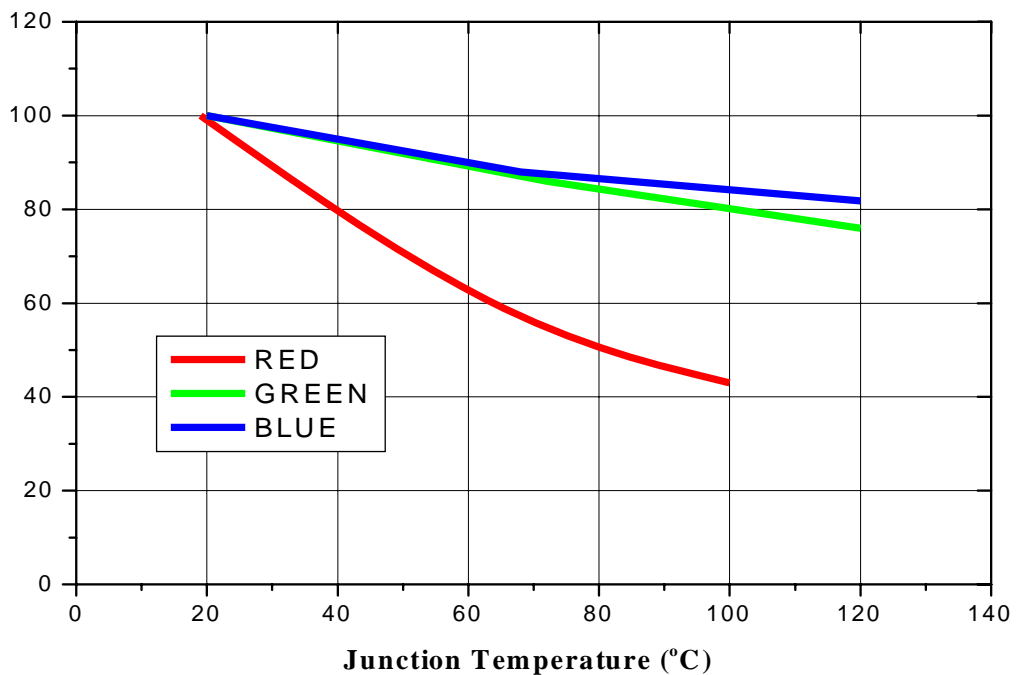

### 17. Ambient Temperature vs. Allowable Forward Current for White, Blue, Green, Cyan

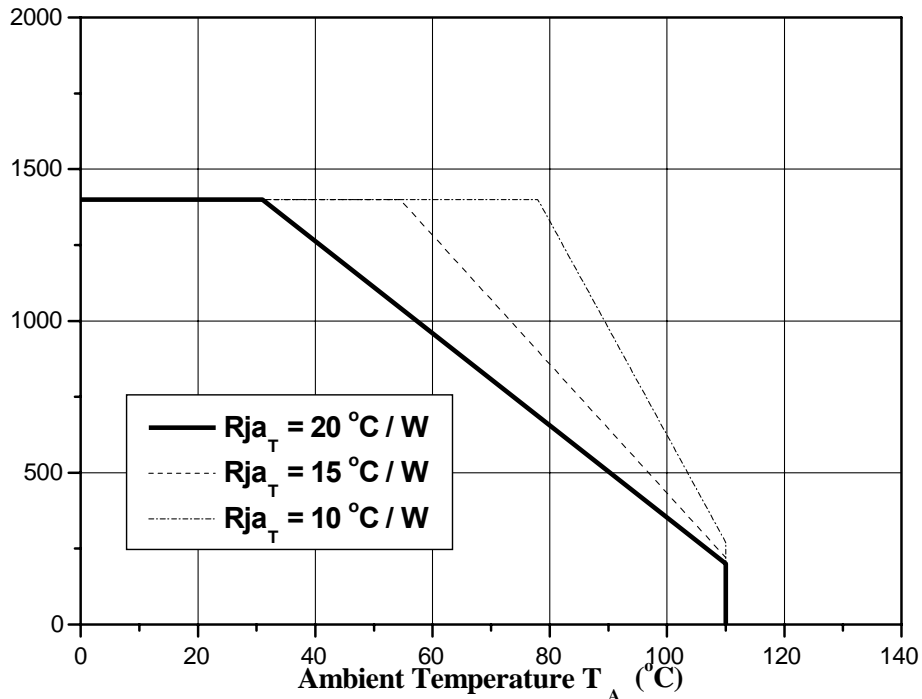

### 18. Ambient Temperature vs. Allowable Forward Current for Red, Amber

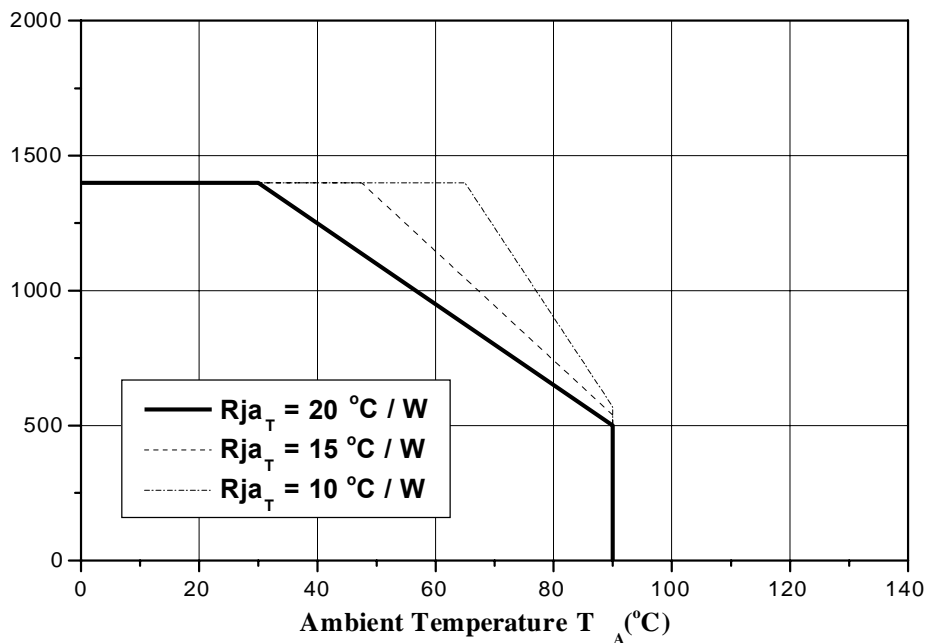

## 19. Reel Packaging

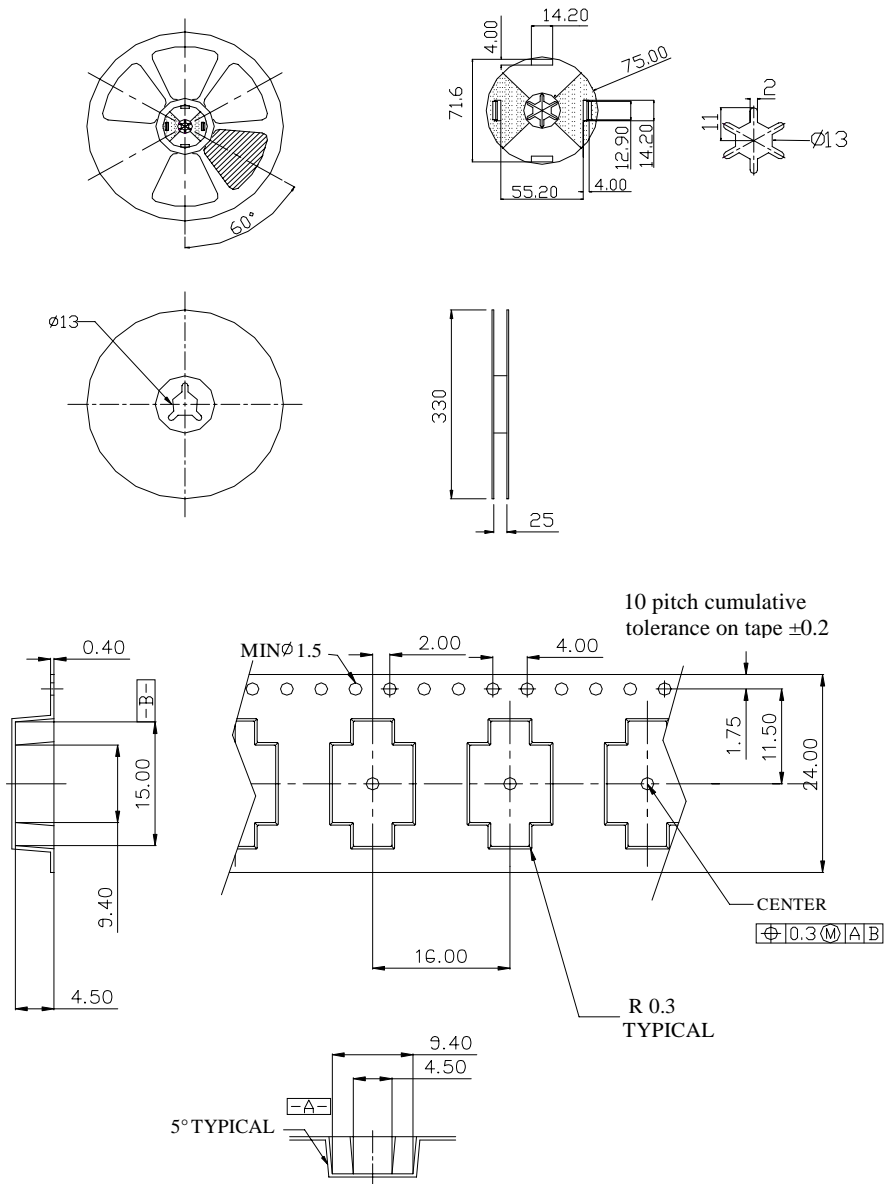

- Note :
1. Loaded pocket number per reel is 250 pieces
  2. All dimensions are in millimeters
  3. Scale none
  4. This drawing is reference only engineering

## 20. Recommended soldering

### 1) Solder pad

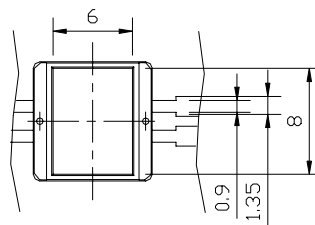
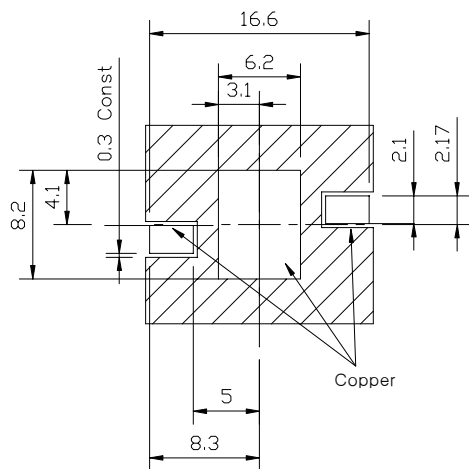
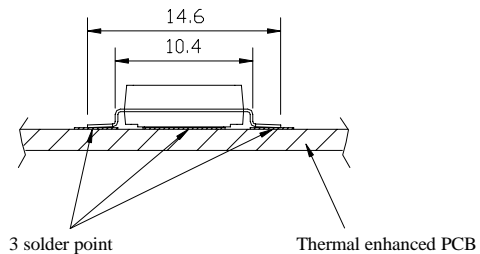

<Rear view>

### 2) Solder paste pattern

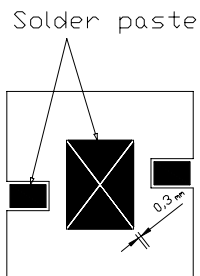

Note : 1. Paste thickness : 0.2mm

## 21. Soldering Profile ( $T_a=25^{\circ}\text{C} \pm 5$ / $\text{RH}=35\% \pm 5$ )

### (1) Reflow Soldering Conditions / Profile

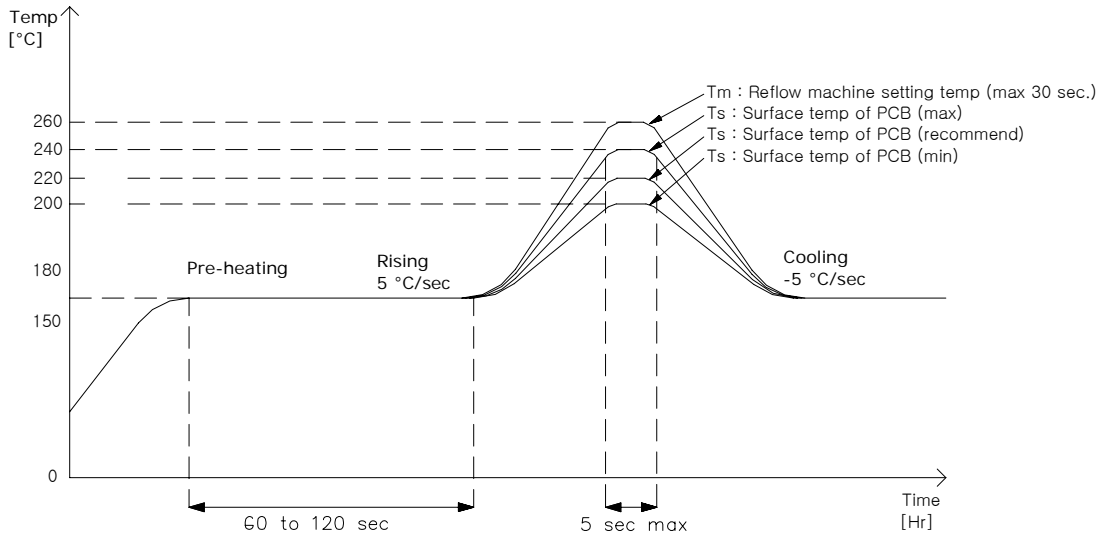

### (2) Hand Soldering conditions

- Lead : Not more than 3 seconds @ MAX 280 °C
- Slug : Use a thermal-adhesives

#### \* Caution

1. Reflow soldering should not be done more than one time.
2. Repairing should not be done after the LED's have been soldered. When repairing is unavoidable, suitable tools must be used.
3. Die slug is to be soldered.
4. When soldering, do not put stress on the LED's during heating.
5. After soldering, do not warp the circuit board.
6. Recommend to use a convection type reflow machine with 7 ~ 8 zones.

# Mouser Electronics

Authorized Distributor

Click to View Pricing, Inventory, Delivery & Lifecycle Information:

[Chicago Miniature:](#)

[CMDA51CB15D13L](#) [CMDA51CW15D13L](#)