

RPC-1.85

Attenuator  
RPC-1.85 Plug - RPC-1.85 Jack

**08AS102-K20S3**

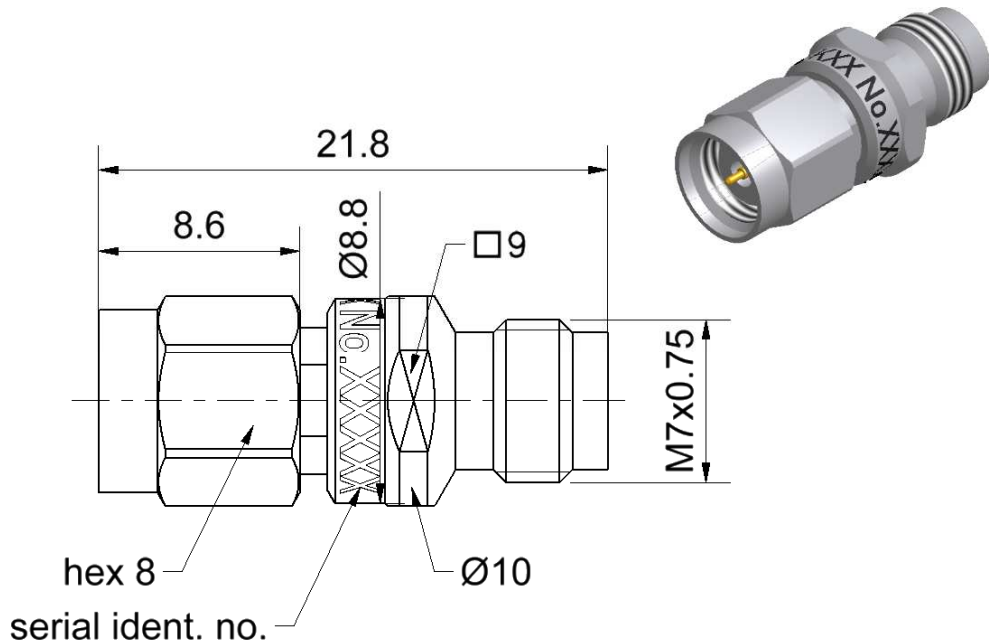

All dimensions are in mm; tolerances according to ISO 2768 m-H

**Interface**

According to IEC 60169-32  
Mechanically compatible with RPC-2.40

**Documents**

N/A

**Material and plating**

**Connector parts**

Center conductor - plug  
Center conductor - jack  
Outer conductor  
Coupling nut  
Dielectric  
Substrate

**Material**

CuBe  
CuBe  
Stainless steel  
Stainless steel  
PS  
Al<sub>2</sub>O<sub>3</sub>

**Plating**

Gold, min. 1.27 µm, over nickel  
Gold, min. 1.27 µm, over nickel  
Passivated  
Passivated

Dieses Dokument ist urheberrechtlich geschützt • This document is protected by copyright • Rosenberger Hochfrequenztechnik GmbH & Co. KG

RF\_35/05:10/6.0

RPC-1.85

Attenuator  
RPC-1.85 Plug - RPC-1.85 Jack

**08AS102-K20S3**

**Electrical data**

Impedance 50 Ω  
 Frequency range DC to 67 GHz  
 Return loss ≥ 32 dB, DC to 4 GHz  
 ≥ 25 dB, 4 GHz to 26.5 GHz  
 ≥ 18 dB, 26.5 GHz to 37 GHz  
 ≥ 12 dB, 37 GHz to 67 GHz  
 Attenuation 20 dB ± 0.5 dB, DC to 26.5 GHz  
 20 dB ± 1.0 dB, 26.5 GHz to 50 GHz  
 20 dB ± 1.5 dB, 50 GHz to 67 GHz  
 Power handling 0.5 W at 25°C

**Mechanical data**

Mating cycles ≥ 500  
 Maximum torque 1.65 Nm  
 Recommended torque 0.90 Nm  
 Gauge 0.00 mm to 0.03 mm

**Environmental data**

Operating temperature range<sup>1</sup> +20 °C to +26 °C  
 Storage temperature range 0 °C to +50 °C  
 RoHS compliant

<sup>1</sup> Temperature range over which these specifications are valid.

**Packing**

Standard 1 pce in box  
 Weight 6.9 g/pce

While the information has been carefully compiled to the best of our knowledge, nothing is intended as representation or warranty on our part and no statement herein shall be construed as recommendation to infringe existing patents. In the effort to improve our products, we reserve the right to make changes judged to be necessary.

Draft	Date	Approved	Date	Rev.	Engineering change number	Name	Date
Marcel Panicke	17.01.08	Lars Ramtke	18.06.15	c00	15-0783	Marion Striegler	18.06.15

Rosenberger Hochfrequenztechnik GmbH & Co. KG P.O.Box 1260 D-84526 Tittmoning Germany www.rosenberger.de	Tel. : +49 8684 18-0 Email : info@rosenberger.de	Page 2 / 2
--	---	---------------

# Mouser Electronics

Authorized Distributor

Click to View Pricing, Inventory, Delivery & Lifecycle Information:

[Rosenberger:](#)

[08AS102-K20S3](#)