

RPC-1.85

Attenuator
RPC-1.85 Plug - RPC-1.85 Jack

08AS102-K06S3

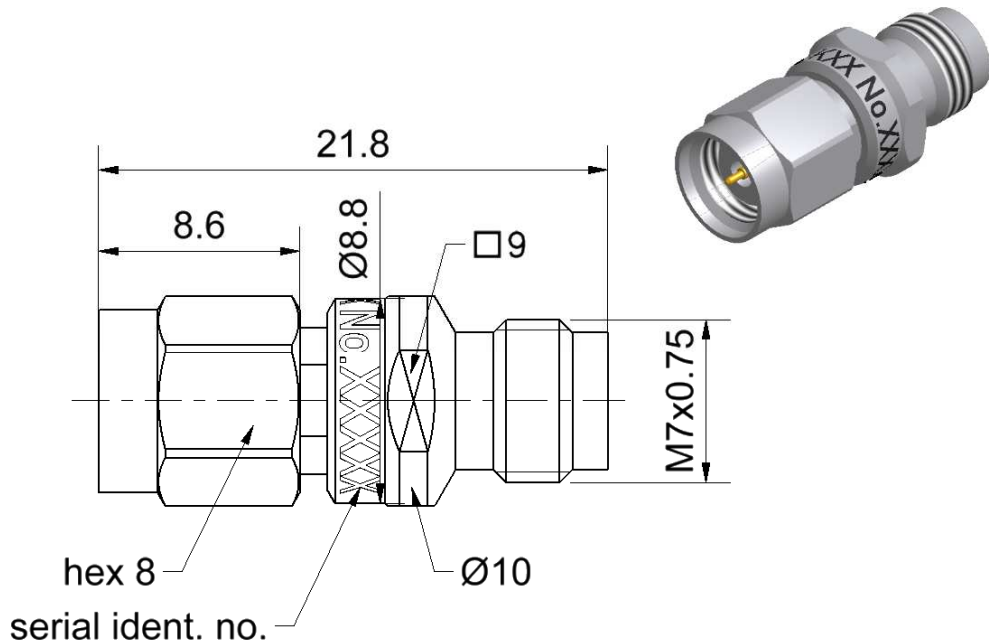

All dimensions are in mm; tolerances according to ISO 2768 m-H

Interface

According to IEC 60169-32
Mechanically compatible with RPC-2.40

Documents

N/A

Material and plating

Connector parts

Center conductor - plug
Center conductor - jack
Outer conductor
Coupling nut
Dielectric
Substrate

Material

CuBe
CuBe
Stainless steel
Stainless steel
PS
Al₂O₃

Plating

Gold, min. 1.27 µm, over nickel
Gold, min. 1.27 µm, over nickel
Passivated
Passivated

Dieses Dokument ist urheberrechtlich geschützt • This document is protected by copyright • Rosenberger Hochfrequenztechnik GmbH & Co. KG

RF_35/05:10/6.0

RPC-1.85

Attenuator
RPC-1.85 Plug - RPC-1.85 Jack

08AS102-K06S3

Electrical data

Impedance 50 Ω
 Frequency range DC to 67 GHz
 Return loss ≥ 32 dB, DC to 4 GHz
 ≥ 25 dB, 4 GHz to 26.5 GHz
 ≥ 18 dB, 26.5 GHz to 37 GHz
 ≥ 12 dB, 37 GHz to 67 GHz
 Attenuation 6 dB ± 0.5 dB, DC to 26.5 GHz
 6 dB ± 1.0 dB, 26.5 GHz to 50 GHz
 6 dB ± 1.5 dB, 50 GHz to 67 GHz
 Power handling 0.5 W at 25°C

Mechanical data

Mating cycles ≥ 500
 Maximum torque 1.65 Nm
 Recommended torque 0.90 Nm
 Gauge 0.00 mm to 0.03 mm

Environmental data

Operating temperature range¹ +20 °C to +26 °C
 Storage temperature range 0 °C to +50 °C
 RoHS compliant

¹ Temperature range over which these specifications are valid.

Packing

Standard 1 pce in box
 Weight 6.9 g/pce

While the information has been carefully compiled to the best of our knowledge, nothing is intended as representation or warranty on our part and no statement herein shall be construed as recommendation to infringe existing patents. In the effort to improve our products, we reserve the right to make changes judged to be necessary.

Draft	Date	Approved	Date	Rev.	Engineering change number	Name	Date
Marcel Panicke	17.01.08	Lars Ramtke	18.06.15	c00	15-0783	Marion Striegler	18.06.15

Rosenberger Hochfrequenztechnik GmbH & Co. KG P.O.Box 1260 D-84526 Tittmoning Germany www.rosenberger.de	Tel. : +49 8684 18-0 Email : info@rosenberger.de	Page 2 / 2
--	---	---------------

Mouser Electronics

Authorized Distributor

Click to View Pricing, Inventory, Delivery & Lifecycle Information:

[Rosenberger:](#)

[08AS102-K06S3](#)