

RPC-N
50 Ω
Attenuator
Plug/Jack

05AS102-K10S3

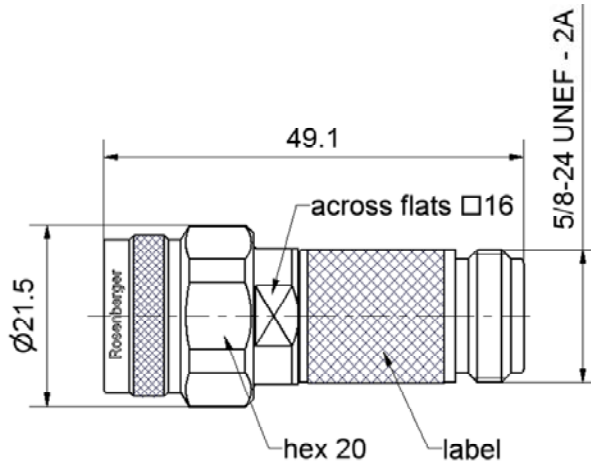

All dimensions are in mm; tolerances according to ISO 2768 m-H

Interface

According to IEC 61169-16 ; CECC 22 210 ; MIL-STD 348A/402

Documents

N/A

Material and plating

Connector parts

- Center conductor - plug
- Center conductor - jack
- Outer conductor
- Coupling nut
- Dielectric
- Substrate

Material

- Brass
- Beryllium copper
- Stainless steel
- Stainless steel
- PPE
- Al₂O₃

Plating

- Gold, min. 1.27 μm, over nickel
- Gold, min. 1.27 μm, over nickel
- Passivated
- Passivated

Dieses Dokument ist urheberrechtlich geschützt • This document is protected by copyright • Rosenberger Hochfrequenztechnik GmbH & Co. KG

RF_35/05.10/6.0

RPC-N
50 Ω Attenuator
Plug/Jack

05AS102-K10S3

Electrical data

Impedance 50 Ω
 Frequency range DC to 18 GHz
 Return loss ≥ 26.4 dB, DC to 4 GHz
 ≥ 23.1 dB, 4 GHz to 12.4 GHz
 ≥ 19.1 dB, 12.4 GHz to 18 GHz
 Attenuation 10 dB ± 0.3 dB, DC to 8 GHz
 10 dB ± 0.6 dB, 8 GHz to 12.4 GHz
 10 dB ± 0.8 dB, 12.4 GHz to 18 GHz
 Power handling 2 W at 25 °C

Mechanical data

Mating cycles ≥ 500
 Maximum torque 1.70 Nm
 Recommended torque 1.10 Nm
 Gauge - plug 5.28 mm to 5.36 mm
 Gauge - jack 5.18 mm to 5.26 mm

Environmental data

Operating temperature range¹ 0 °C to +50 °C
 Storage temperature range -40 °C to +85 °C
 2002/95/EC (RoHS) compliant

¹ Temperature range over which these specifications are valid.

Packing

Standard 1 pce in box
 Weight 59.0 g/pce

While the information has been carefully compiled to the best of our knowledge, nothing is intended as representation or warranty on our part and no statement herein shall be construed as recommendation to infringe existing patents. In the effort to improve our products, we reserve the right to make changes judged to be necessary.

Draft	Date	Approved	Date	Rev.	Engineering change number	Name	Date
Kerstin Herzog	06/01/05	Frank Weiß	24/01/12	e00	11-0832	Marion Striegler	19/01/12
Rosenberger Hochfrequenztechnik GmbH & Co. KG P.O.Box 1260 D-84526 Tittmoning Germany www.rosenberger.de					Tel. : +49 8684 18-0 Fax : +49 8684 18-499 Email : info@rosenberger.de		Page 2 / 2

Mouser Electronics

Authorized Distributor

Click to View Pricing, Inventory, Delivery & Lifecycle Information:

[Rosenberger:](#)

[05AS102-K10S3](#)