

BCR16CM-12LB

600V - 16A - Triac

Medium Power Use

R07DS1032EJ0500

Rev.5.00

Jun. 28, 2018

Features

- $I_T (RMS)$: 16 A
- V_{DRM} : 600 V
- I_{FGT} , I_{RGT} , $I_{RGT III}$: 30 mA (20 mA) ^{Note6}
- T_j : 150°C
- Non-insulated Type
- Planar Passivation Type

Outline

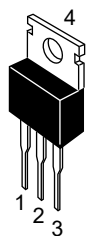
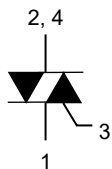
<p>RENESAS Package code: PRSS0004AG-A (Package name: TO-220AB)</p>  <p>To be EOLed PKG</p>	<p>RENESAS Package code: PRSS0004AT-A (Package name: TO-220ABA)</p> 	 <p>1. T₁ Terminal 2. T₂ Terminal 3. Gate Terminal 4. T₂ Terminal</p>
----------------------------------------------------------------------------------------------------------------------------------------------------------------------------------------	-----------------------------------------------------------------------------------------------------------------------------------------------------------	-------------------------------------------------------------------------------------------------------------------------------------------------------------------------------------------------------

Application

Power supply, motor control, heater control, solenoid control, and other general purpose AC control applications.

Maximum Ratings

Parameter	Symbol	Voltage class	
		12	Unit
Repetitive peak off-state voltage ^{Note1}	V_{DRM}	600	V
Non-repetitive peak off-state voltage ^{Note1}	V_{DSM}	720	V

Parameter	Symbol	Ratings	Unit	Conditions
RMS on-state current	$I_T (RMS)$	16	A	Commercial frequency, sine full wave 360° conduction, $T_c = 125^\circ\text{C}$ ^{Note3}
Surge on-state current	I_{TSM}	170	A	60 Hz sinewave 1 full cycle, peak value, non-repetitive
I^2t for fusion	I^2t	121	A ² s	Value corresponding to 1 cycle of half wave 60 Hz, surge on-state current
Peak gate power dissipation	P_{GM}	5	W	
Average gate power dissipation	$P_{G(AV)}$	0.5	W	
Peak gate voltage	V_{GM}	10	V	
Peak gate current	I_{GM}	2	A	
Junction Temperature	T_j	-40 to +150	°C	
Storage temperature	T_{stg}	-40 to +150	°C	

Electrical Characteristics

Parameter	Symbol	Min.	Typ.	Max.	Unit	Test conditions
Repetitive peak off-state current	I_{DRM}	—	—	2.0	mA	$T_j = 150^\circ\text{C}$, V_{DRM} applied
On-state voltage	V_{TM}	—	—	1.5	V	$T_c = 25^\circ\text{C}$, $I_{TM} = 25\text{ A}$, instantaneous measurement
Gate trigger voltage ^{Note2}	I	V_{FGTI}	—	—	1.5	$T_j = 25^\circ\text{C}$, $V_D = 6\text{ V}$, $R_L = 6\ \Omega$, $R_G = 330\ \Omega$
	II	V_{RGTI}	—	—	1.5	
	III	V_{RGTIII}	—	—	1.5	
Gate trigger current ^{Note2}	I	I_{FGTI}	—	—	30 ^{Note6}	$T_j = 25^\circ\text{C}$, $V_D = 6\text{ V}$, $R_L = 6\ \Omega$, $R_G = 330\ \Omega$
	II	I_{RGTI}	—	—	30 ^{Note6}	
	III	I_{RGTIII}	—	—	30 ^{Note6}	
Gate non-trigger voltage	V_{GD}	0.2	—	—	V	$T_j = 125^\circ\text{C}$, $V_D = 1/2 V_{DRM}$
		0.1	—	—	V	$T_j = 150^\circ\text{C}$, $V_D = 1/2 V_{DRM}$
Thermal resistance	$R_{th(j-c)}$	—	—	1.4	$^\circ\text{C/W}$	Junction to case ^{Note3 Note4}
Critical-rate of rise of off-state commutation voltage ^{Note5}	$(dv/dt)_c$	10	—	—	$\text{V}/\mu\text{s}$	$T_j = 125^\circ\text{C}$
		1	—	—	$\text{V}/\mu\text{s}$	$T_j = 150^\circ\text{C}$

- Notes: 1. Gate open.
 2. Measurement using the gate trigger characteristics measurement circuit.
 3. Case temperature is measured at the T_2 tab 1.5 mm away from the molded case.
 4. The contact thermal resistance $R_{th(c-f)}$ in case of greasing is 1.0°C/W .
 5. Test conditions of the critical-rate of rise of off-state commutation voltage is shown in the table below.
 6. High sensitivity ($I_{GT} \leq 20\text{ mA}$) is also available. (I_{GT} item:1)

Test conditions	Commutating voltage and current waveforms (inductive load)
1. Junction temperature $T_j = 125^\circ\text{C}/150^\circ\text{C}$ 2. Rate of decay of on-state commutating current $(di/dt)_c = -8.0\text{ A/ms}$ 3. Peak off-state voltage $V_D = 400\text{ V}$	

Performance Curves

Maximum On-State Characteristics

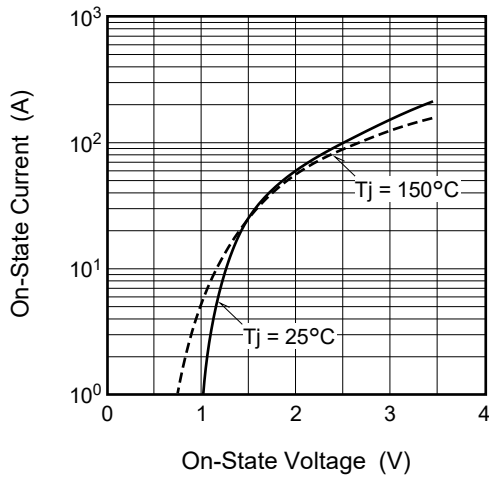

Rated Surge On-State Current

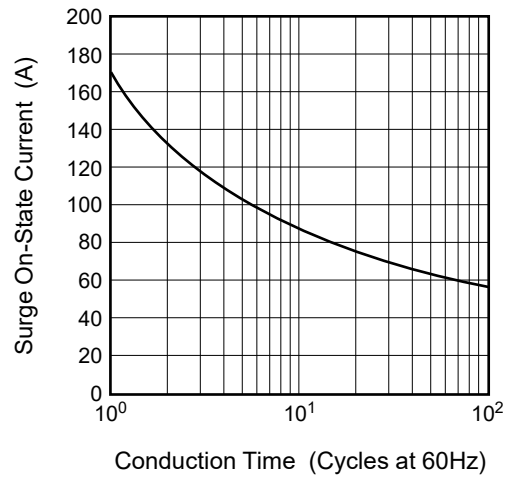

Gate Characteristics (I, II and III)

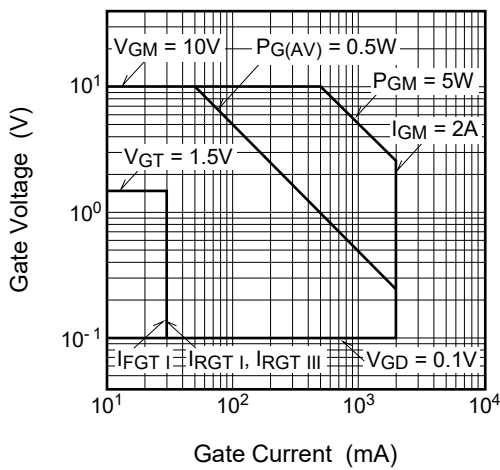

Gate Trigger Current vs. Junction Temperature

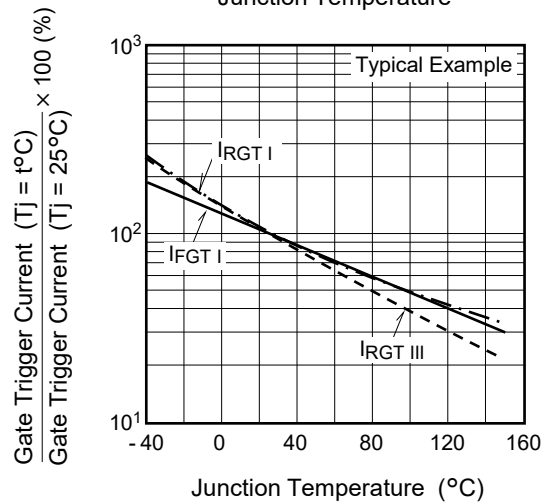

Gate Trigger Voltage vs. Junction Temperature

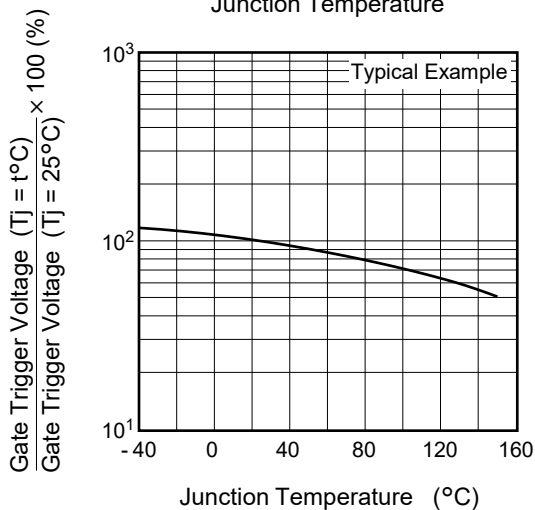

Gate Trigger Current vs. Gate Current Pulse Width

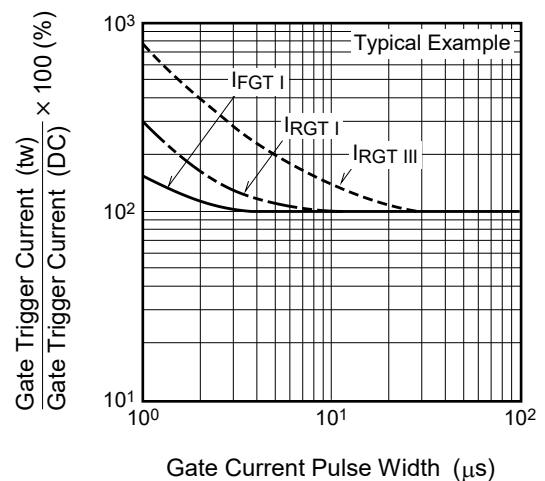

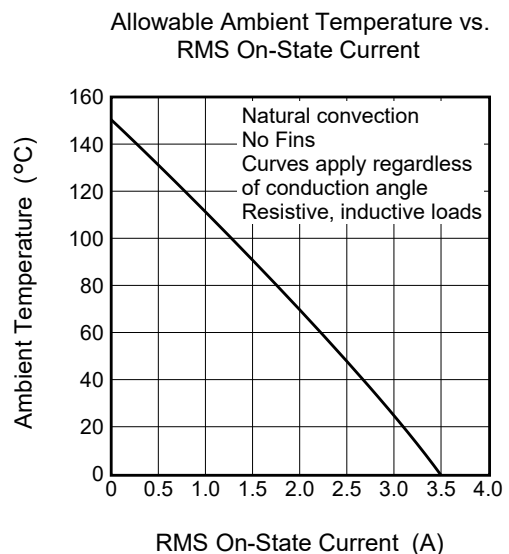
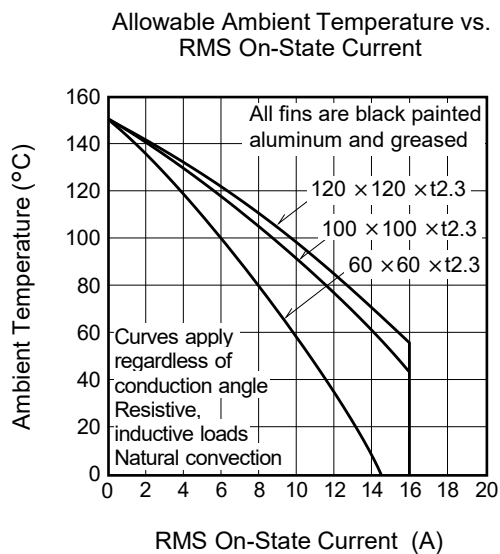
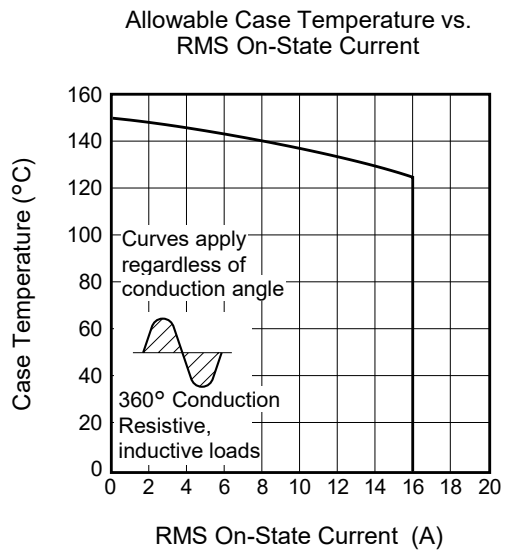
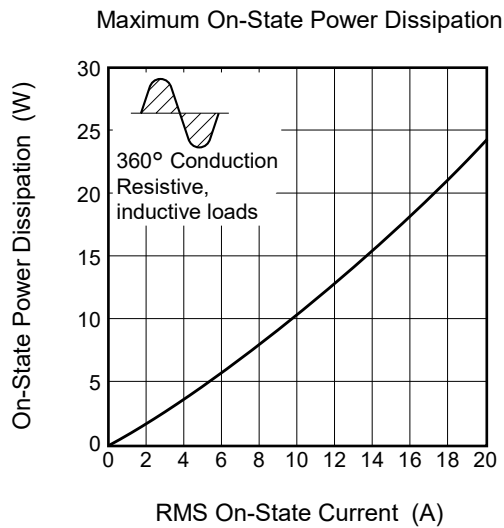
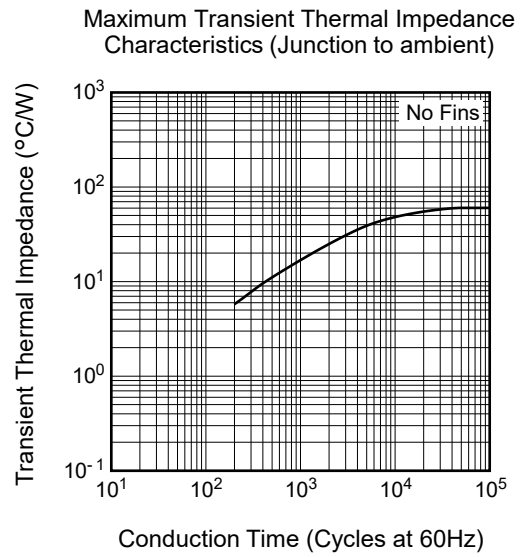
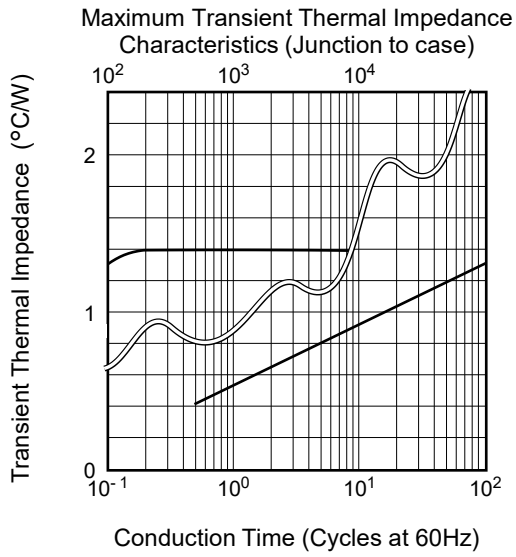

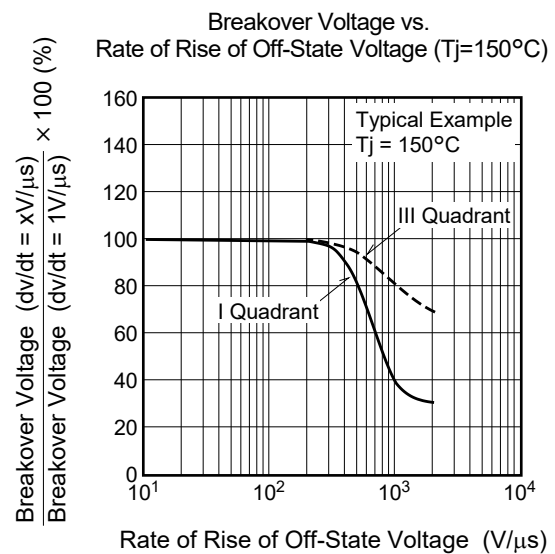
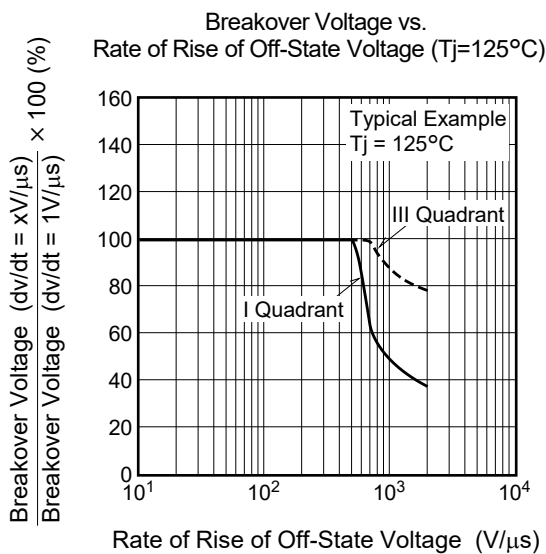
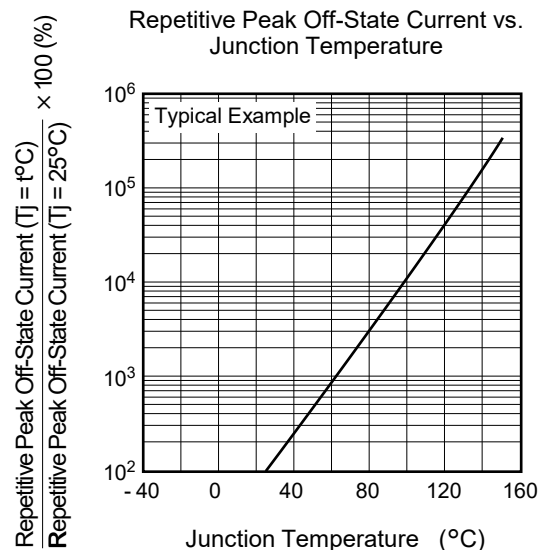
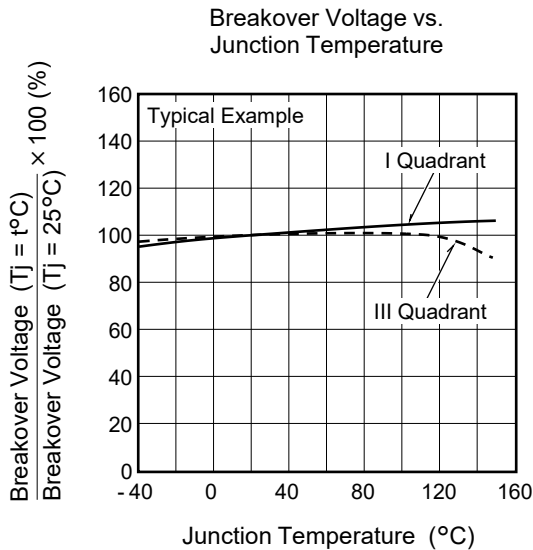
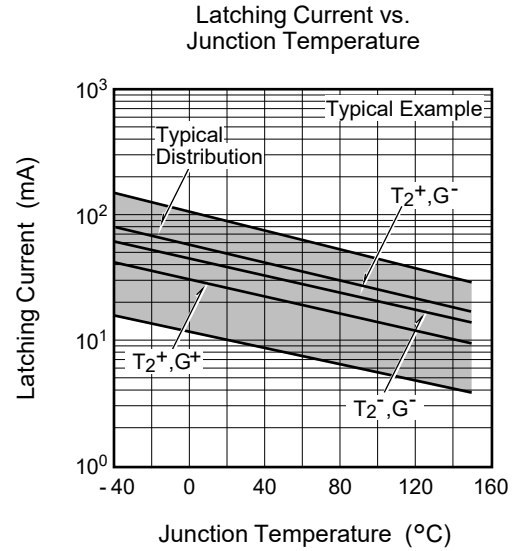
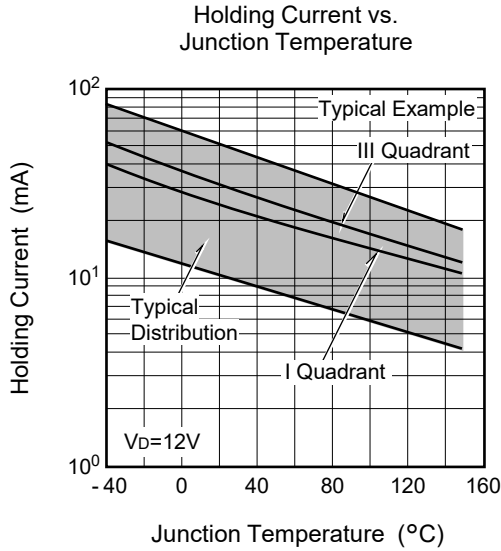

Commutation Characteristics (Tj=125°C)

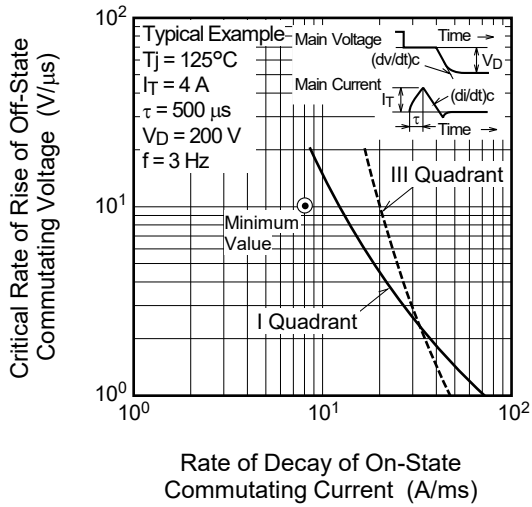

Commutation Characteristics (Tj=150°C)

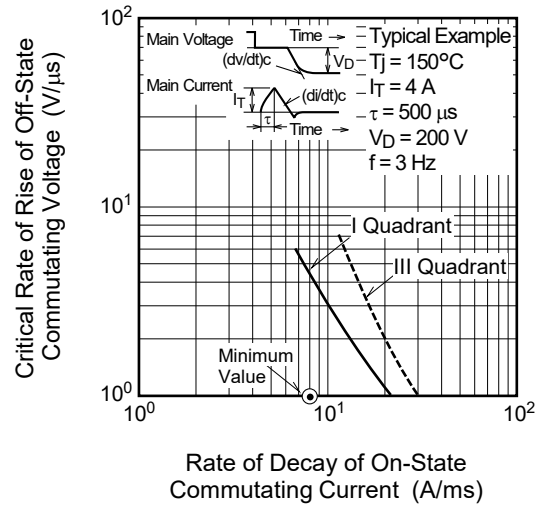

Gate Trigger Characteristics Test Circuits

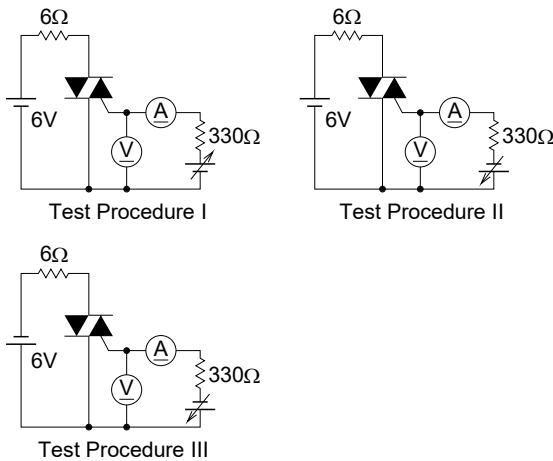

Recommended peripheral components for Triac

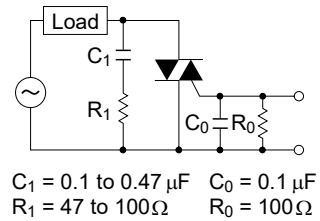

Package Dimensions

Ordering code: #BH0

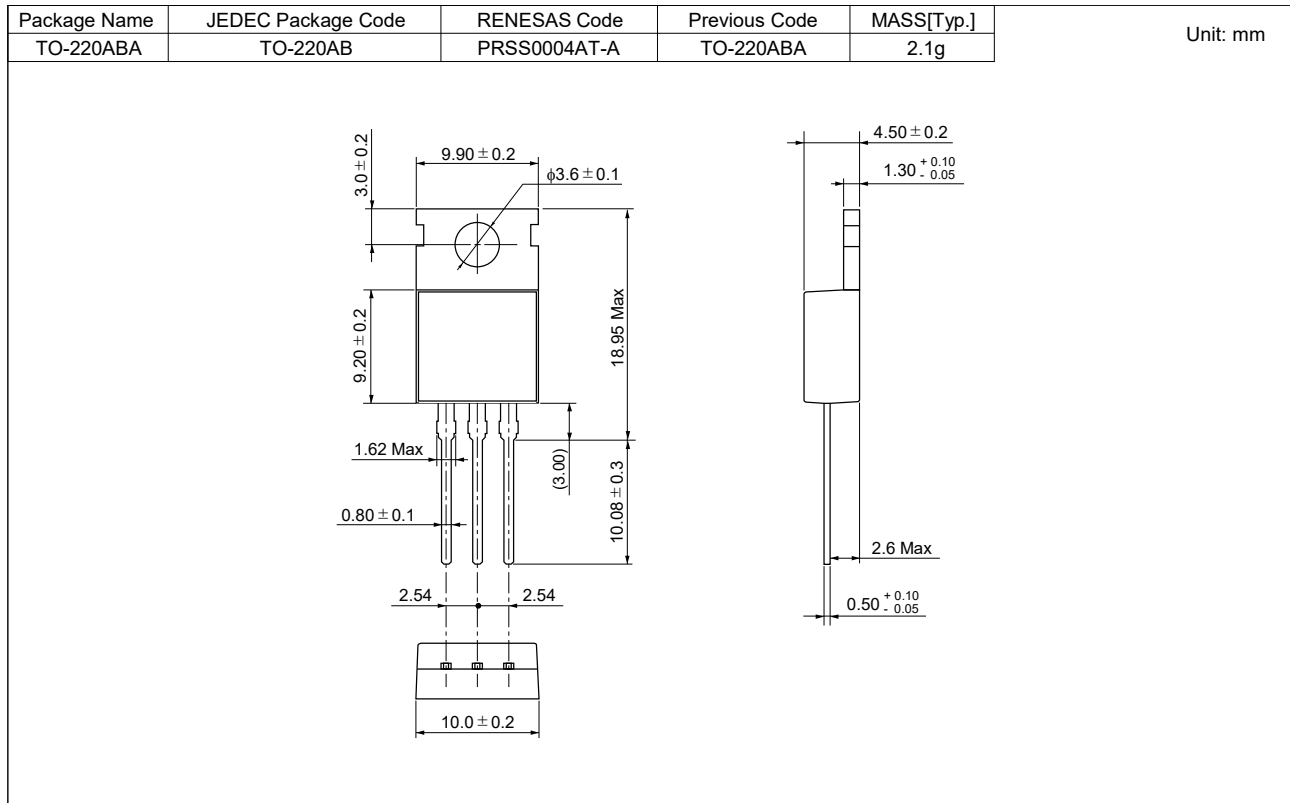

Ordering code: #BB0

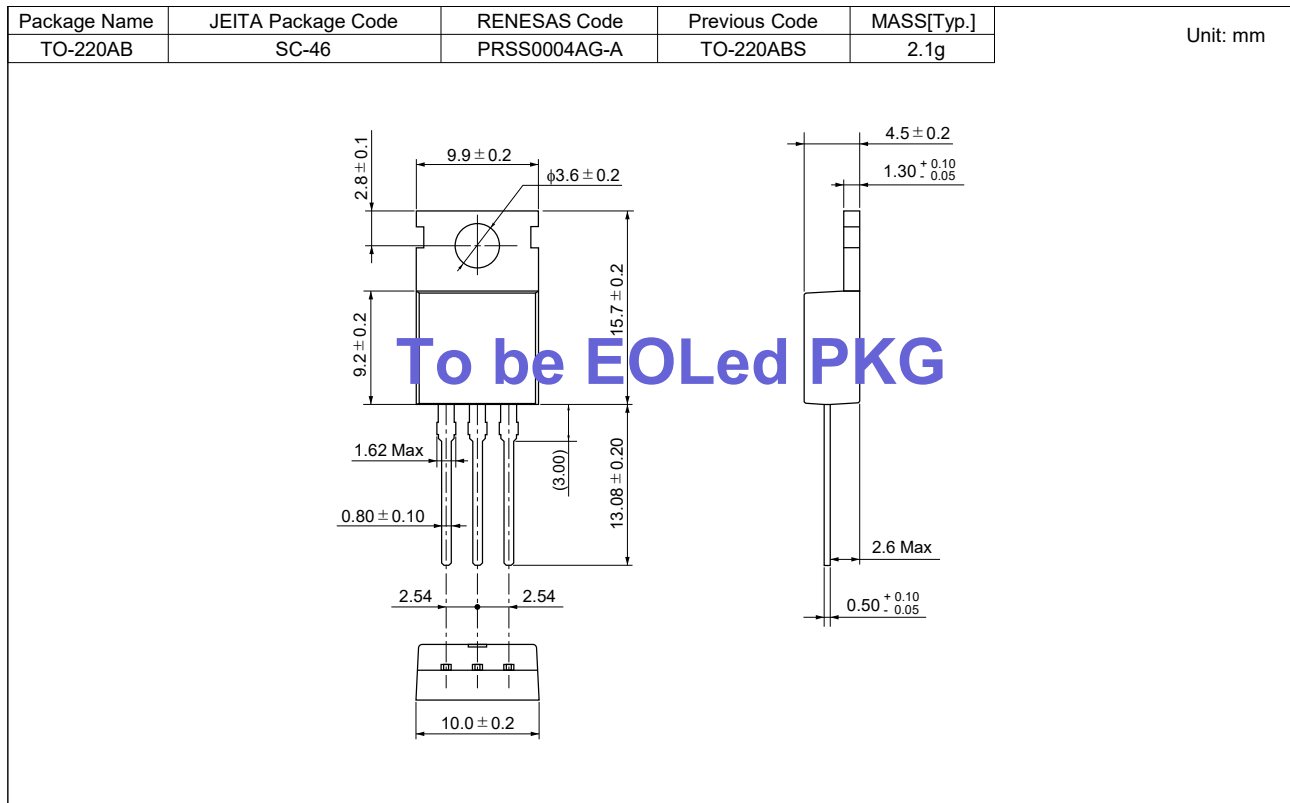

Ordering Information

Orderable Part Number	Package	Quantity ^{Note7}	Remark	Status
BCR16CM-12LB#BH0	TO-220ABA	50 pcs./ tube	Straight type	Mass Production
BCR16CM-12LB-1#BH0	TO-220ABA	50 pcs./ tube	Straight type, I _{GT} item:1	
BCR16CM-12LB#BB0	TO-220ABS	50 pcs./ tube	Straight type	EOL Candidate
BCR16CM-12LB-1#BB0	TO-220ABS	50 pcs./ tube	Straight type, I _{GT} item:1	
BCR16CM-12LB□□#BB0	TO-220ABS	50 pcs./ tube	□□:Lead form type	
BCR16CM12LB1□□#BB0	TO-220ABS	50 pcs./ tube	□□:Lead form type, I _{GT} item:1	

Notes: 7. Please confirm the specification about the shipping in detail.

Notice

1. Descriptions of circuits, software and other related information in this document are provided only to illustrate the operation of semiconductor products and application examples. You are fully responsible for the incorporation or any other use of the circuits, software, and information in the design of your product or system. Renesas Electronics disclaims any and all liability for any losses and damages incurred by you or third parties arising from the use of these circuits, software, or information.
2. Renesas Electronics hereby expressly disclaims any warranties against and liability for infringement or any other disputes involving patents, copyrights, or other intellectual property rights of third parties, by or arising from the use of Renesas Electronics products or technical information described in this document, including but not limited to, the product data, drawing, chart, program, algorithm, application examples.
3. No license, express, implied or otherwise, is granted hereby under any patents, copyrights or other intellectual property rights of Renesas Electronics or others.
4. You shall not alter, modify, copy, or otherwise misappropriate any Renesas Electronics product, whether in whole or in part. Renesas Electronics disclaims any and all liability for any losses or damages incurred by you or third parties arising from such alteration, modification, copy or otherwise misappropriation of Renesas Electronics products.
5. Renesas Electronics products are classified according to the following two quality grades: "Standard" and "High Quality". The intended applications for each Renesas Electronics product depends on the product's quality grade, as indicated below.
"Standard": Computers; office equipment; communications equipment; test and measurement equipment; audio and visual equipment; home electronic appliances; machine tools; personal electronic equipment; and industrial robots etc.
"High Quality": Transportation equipment (automobiles, trains, ships, etc.); traffic control (traffic lights); large-scale communication equipment; key financial terminal systems; safety control equipment; etc.
Renesas Electronics products are neither intended nor authorized for use in products or systems that may pose a direct threat to human life or bodily injury (artificial life support devices or systems, surgical implantations etc.), or may cause serious property damages (space and undersea repeaters; nuclear power control systems; aircraft control systems; key plant systems; military equipment; etc.). Renesas Electronics disclaims any and all liability for any damages or losses incurred by you or third parties arising from the use of any Renesas Electronics product for which the product is not intended by Renesas Electronics.
6. When using the Renesas Electronics products, refer to the latest product information (data sheets, user's manuals, application notes, "General Notes for Handling and Using Semiconductor Devices" in the reliability handbook, etc.), and ensure that usage conditions are within the ranges specified by Renesas Electronics with respect to maximum ratings, operating power supply voltage range, heat radiation characteristics, installation, etc. Renesas Electronics disclaims any and all liability for any malfunctions or failure or accident arising out of the use of Renesas Electronics products beyond such specified ranges.
7. Although Renesas Electronics endeavors to improve the quality and reliability of Renesas Electronics products, semiconductor products have specific characteristics such as the occurrence of failure at a certain rate and malfunctions under certain use conditions. Further, Renesas Electronics products are not subject to radiation resistance design. Please ensure to implement safety measures to guard them against the possibility of bodily injury, injury or damage caused by fire, and social damage in the event of failure or malfunction of Renesas Electronics products, such as safety design for hardware and software including but not limited to redundancy, fire control and malfunction prevention, appropriate treatment for aging degradation or any other appropriate measures by your own responsibility as warranty for your products/system. Because the evaluation of microcomputer software alone is very difficult and not practical, please evaluate the safety of the final products or systems manufactured by you.
8. Please contact a Renesas Electronics sales office for details as to environmental matters such as the environmental compatibility of each Renesas Electronics product. Please investigate applicable laws and regulations that regulate the inclusion or use of controlled substances, including without limitation, the EU RoHS Directive carefully and sufficiently and use Renesas Electronics products in compliance with all these applicable laws and regulations. Renesas Electronics disclaims any and all liability for damages or losses occurring as a result of your noncompliance with applicable laws and regulations.
9. Renesas Electronics products and technologies shall not be used for or incorporated into any products or systems whose manufacture, use, or sale is prohibited under any applicable domestic or foreign laws or regulations. You shall not use Renesas Electronics products or technologies for (1) any purpose relating to the development, design, manufacture, use, stockpiling, etc., of weapons of mass destruction, such as nuclear weapons, chemical weapons, or biological weapons, or missiles (including unmanned aerial vehicles (UAVs)) for delivering such weapons, (2) any purpose relating to the development, design, manufacture, or use of conventional weapons, or (3) any other purpose of disturbing international peace and security, and you shall not sell, export, lease, transfer, or release Renesas Electronics products or technologies to any third party whether directly or indirectly with knowledge or reason to know that the third party or any other party will engage in the activities described above. When exporting, selling, transferring, etc., Renesas Electronics products or technologies, you shall comply with any applicable export control laws and regulations promulgated and administered by the governments of the countries asserting jurisdiction over the parties or transactions.
10. Please acknowledge and agree that you shall bear all the losses and damages which are incurred from the misuse or violation of the terms and conditions described in this document, including this notice, and hold Renesas Electronics harmless, if such misuse or violation results from your resale or making Renesas Electronics products available any third party.
11. This document shall not be reprinted, reproduced or duplicated in any form, in whole or in part, without prior written consent of Renesas Electronics.
12. Please contact a Renesas Electronics sales office if you have any questions regarding the information contained in this document or Renesas Electronics products.
(Note 1) "Renesas Electronics" as used in this document means Renesas Electronics Corporation and also includes its majority-owned subsidiaries.
(Note 2) "Renesas Electronics product(s)" means any product developed or manufactured by or for Renesas Electronics.

(Rev.3.0-1 November 2016)



SALES OFFICES

Renesas Electronics Corporation

<http://www.renesas.com>

Refer to "<http://www.renesas.com/>" for the latest and detailed information.

Renesas Electronics America Inc.

2801 Scott Boulevard Santa Clara, CA 95050-2549, U.S.A.
Tel: +1-408-588-6000, Fax: +1-408-588-6130

Renesas Electronics Canada Limited

9251 Yonge Street, Suite 8309 Richmond Hill, Ontario Canada L4C 9T3
Tel: +1-905-237-2004

Renesas Electronics Europe Limited

Dukes Meadow, Millboard Road, Bourne End, Buckinghamshire, SL8 5FH, U.K.
Tel: +44-1628-585-100, Fax: +44-1628-585-900

Renesas Electronics Europe GmbH

Arcadiastrasse 10, 40472 Düsseldorf, Germany
Tel: +49-211-6503-0, Fax: +49-211-6503-1327

Renesas Electronics (China) Co., Ltd.

Room 1709, Quantum Plaza, No.27 ZhiChunLu Haidian District, Beijing 100191, P.R.China
Tel: +86-10-8235-1155, Fax: +86-10-8235-7679

Renesas Electronics (Shanghai) Co., Ltd.

Unit 301, Tower A, Central Towers, 555 Langao Road, Putuo District, Shanghai, P. R. China 200333
Tel: +86-21-2226-0888, Fax: +86-21-2226-0999

Renesas Electronics Hong Kong Limited

Unit 1601-1611, 16/F., Tower 2, Grand Century Place, 193 Prince Edward Road West, Mongkok, Kowloon, Hong Kong
Tel: +852-2265-6688, Fax: +852-2886-9022

Renesas Electronics Taiwan Co., Ltd.

13F, No. 363, Fu Shing North Road, Taipei 10543, Taiwan
Tel: +886-2-8175-9600, Fax: +886-2-8175-9670

Renesas Electronics Singapore Pte. Ltd.

80 Bendemeer Road, Unit #06-02 Hyflux Innovation Centre, Singapore 339949
Tel: +65-6213-0200, Fax: +65-6213-0300

Renesas Electronics Malaysia Sdn.Bhd.

Unit 1207, Block B, Menara Amcorp, Amcorp Trade Centre, No. 18, Jln Persiaran Barat, 46050 Petaling Jaya, Selangor Darul Ehsan, Malaysia
Tel: +60-3-7955-9390, Fax: +60-3-7955-9510

Renesas Electronics India Pvt. Ltd.

No.777C, 100 Feet Road, HAL II Stage, Indiranagar, Bangalore, India
Tel: +91-80-67208700, Fax: +91-80-67208777

Renesas Electronics Korea Co., Ltd.

12F., 234 Teheran-ro, Gangnam-Gu, Seoul, 135-080, Korea
Tel: +82-2-558-3737, Fax: +82-2-558-5141

Mouser Electronics

Authorized Distributor

Click to View Pricing, Inventory, Delivery & Lifecycle Information:

[Renesas Electronics:](#)

[BCR16CM-12LB#BB0](#)