

EL7202, EL7212, EL7222

High Speed, Dual Channel Power MOSFET Drivers

FN7282
Rev 2.00
July 3, 2006

The EL7202, EL7212, EL7222 ICs are matched dual-drivers that improve the operation of the industry standard DS0026 clock drivers. The Elantec versions are very high speed drivers capable of delivering peak currents of 2.0 amps into highly capacitive loads. The high speed performance is achieved by means of a proprietary "Turbo-Drive" circuit that speeds up input stages by tapping the wider voltage swing at the output. Improved speed and drive capability are enhanced by matched rise and fall delay times. These matched delays maintain the integrity of input-to-output pulse-widths to reduce timing errors and clock skew problems. This improved performance is accompanied by a 10 fold reduction in supply currents over bipolar drivers, yet without the delay time problems commonly associated with CMOS devices. Dynamic switching losses are minimized with non-overlapped drive techniques.

Pinouts

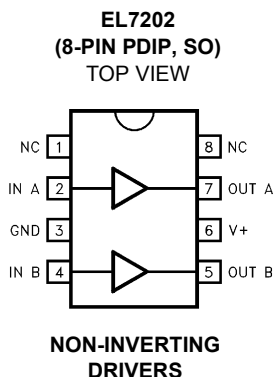
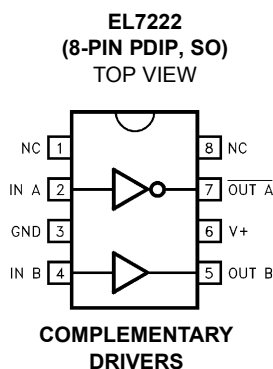
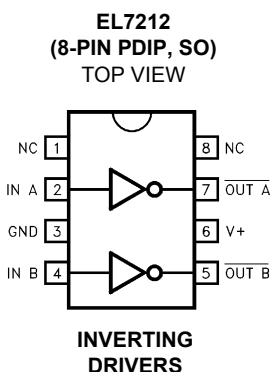

Manufactured under U.S. Patent Nos. 5,334,883, #5,341,047

Features

- Industry standard driver replacement
- Improved response times
- Matched rise and fall times
- Reduced clock skew
- Low output impedance
- Low input capacitance
- High noise immunity
- Improved clocking rate
- Low supply current
- Wide operating voltage range
- Pb-Free available (RoHS compliant)

Applications

- Clock/line drivers
- CCD Drivers
- Ultra-sound transducer drivers
- Power MOSFET drivers
- Switch mode power supplies
- Class D switching amplifiers
- Ultrasonic and RF generators
- Pulsed circuits

Ordering Information

Part Number	PART MARKING	TAPE & REEL	PACKAGE	PKG. DWG. #
EL7202CN	EL7202CN	-	8 Ld PDIP	MDP0031
EL7202CS	7202CS	-	8 Ld SOIC	MDP0027
EL7202CS-T7	7202CS	7"	8 Ld SOIC	MDP0027
EL7202CS-T13	7202CS	13"	8 Ld SOIC	MDP0027
EL7202CSZ (See Note)	7202CSZ	-	8 Ld SOIC (Pb-free)	MDP0027
EL7202CSZ-T7 (See Note)	7202CSZ	7"	8 Ld SOIC (Pb-free)	MDP0027
EL7202CSZ-T13 (See Note)	7202CSZ	13"	8 Ld SOIC (Pb-free)	MDP0027
EL7212CN	EL7212CN	-	8 Ld PDIP	MDP0031
EL7212CNZ	EL7212CN Z	-	8 Ld PDIP* (Pb-free)	MDP0031
EL7212CS	7212CS	-	8 Ld SOIC	MDP0027
EL7212CS-T7	7212CS	7"	8 Ld SOIC	MDP0027
EL7212CS-T13	7212CS	13"	8 Ld SOIC	MDP0027
EL7212CSZ (See Note)	7212CSZ	-	8 Ld SOIC (Pb-free)	MDP0027
EL7212CSZ-T7 (See Note)	7212CSZ	7"	8 Ld SOIC (Pb-free)	MDP0027
EL7212CSZ-T13 (See Note)	7212CSZ	13"	8 Ld SOIC (Pb-free)	MDP0027
EL7222CN	EL7222CN	-	8 Ld PDIP	MDP0031
EL7222CS	7222CS	-	8 Ld SOIC	MDP0027
EL7222CS-T7	7222CS	7"	8 Ld SOIC	MDP0027
EL7222CS-T13	7222CS	13"	8 Ld SOIC	MDP0027
EL7222CSZ (See Note)	7222CSZ	-	8 Ld SOIC (Pb-free)	MDP0027
EL7222CSZ-T7 (See Note)	7222CSZ	7"	8 Ld SOIC (Pb-free)	MDP0027
EL7222CSZ-T13 (See Note)	7222CSZ	13"	8 Ld SOIC (Pb-free)	MDP0027

NOTE: Intersil Pb-free products employ special Pb-free material sets; molding compounds/die attach materials and 100% matte tin plate termination finish, which are RoHS compliant and compatible with both SnPb and Pb-free soldering operations. Intersil Pb-free products are MSL classified at Pb-free peak reflow temperatures that meet or exceed the Pb-free requirements of IPC/JEDEC J STD-020.

*Pb-free PDIPs can be used for through hole wave solder processing only. They are not intended for use in Reflow solder processing applications.

Absolute Maximum Ratings (T_A = 25°C)

Supply (V+ to Gnd)	16.5V	Operating Junction Temperature	125°C
Input Pins	-0.3V to +0.3V above V+	Power Dissipation	
Combined Peak Output Current4A	SOIC570mW
Storage Temperature Range	-65°C to +150°C	PDIP	1050mW
Ambient Operating Temperature	-40°C to +85°C		

CAUTION: Stresses above those listed in "Absolute Maximum Ratings" may cause permanent damage to the device. This is a stress only rating and operation of the device at these or any other conditions above those indicated in the operational sections of this specification is not implied.

IMPORTANT NOTE: All parameters having Min/Max specifications are guaranteed. Typical values are for information purposes only. Unless otherwise noted, all tests are at the specified temperature and are pulsed tests, therefore: T_J = T_C = T_A

DC Electrical Specifications T_A = 25°C, V = 15V unless otherwise specified

parameter	Description	Test Conditions	Min	Typ	Max	Units
INPUT						
V _{IH}	Logic "1" Input Voltage		2.4			V
I _{IH}	Logic "1" Input Current	@V+		0.1	10	µA
V _{IL}	Logic "0" Input Voltage				0.8	V
I _{IL}	Logic "0" Input Current	@0V		0.1	10	µA
V _{HVS}	Input Hysteresis			0.3		V
OUTPUT						
R _{OH}	Pull-Up Resistance	I _{OUT} = -100mA		3	6	Ω
R _{OL}	Pull-Down Resistance	I _{OUT} = +100mA		4	6	Ω
I _{PK}	Peak Output Current	Source Sink		2 2		A
I _{DC}	Continuous Output Current	Source/Sink	100			mA
POWER SUPPLY						
I _S	Power Supply Current	Inputs High/EL7202 Inputs High/EL7212 Inputs High/EL7222		4.5 1 2.5	7.5 2.5 5.0	mA
V _S	Operating Voltage		4.5		15	V

AC Electrical Specifications T_A = 25°C, V = 15V unless otherwise specified

parameter	Description	Test Conditions	Min	Typ	Max	Units
SWITCHING CHARACTERISTICS						
t _R	Rise Time	C _L = 500pF C _L = 1000pF		7.5 10	20	ns
t _F	Fall Time	C _L = 500pF C _L = 1000pF		10 13	20	ns
t _{D1}	Turn-On Delay Time	See Timing Table		18	25	ns
t _{D2}	Turn-Off Delay Time	See Timing Table		20	25	ns

Timing Table

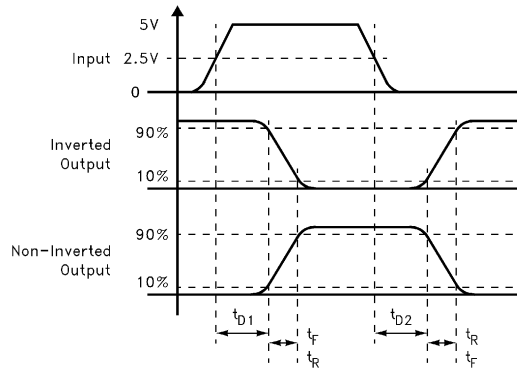

Standard Test Configuration

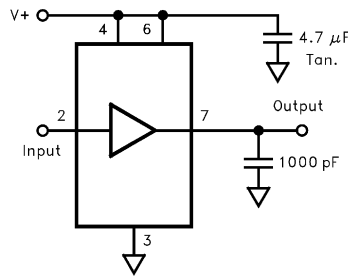

Simplified Schematic

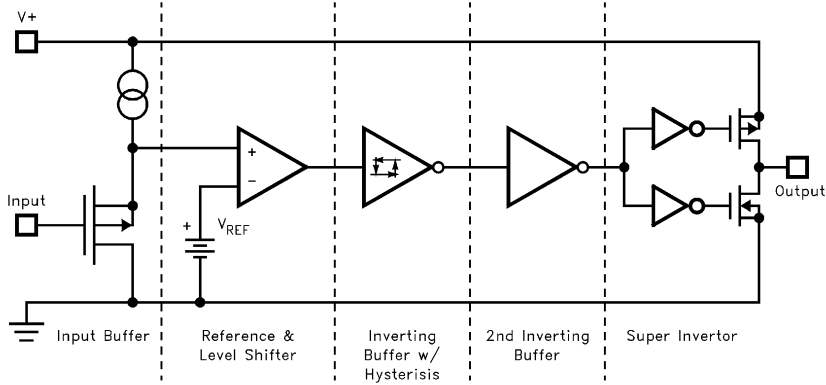

Typical Performance Curves

MAX POWER/DERATING CURVES

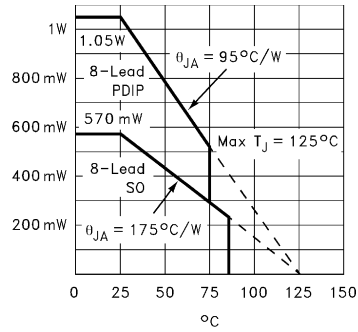

SWITCH THRESHOLD vs SUPPLY VOLTAGE

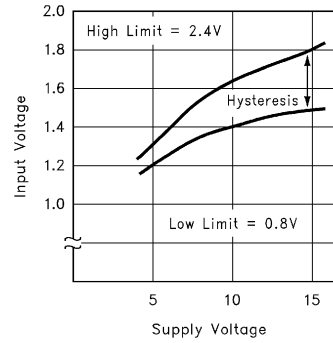

INPUT CURRENT vs VOLTAGE

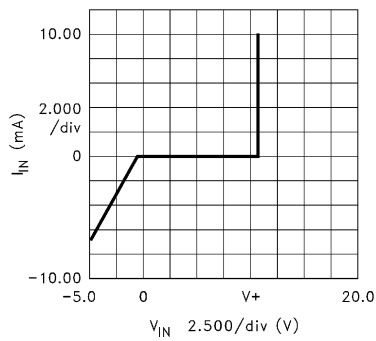

PEAK DRIVE vs SUPPLY VOLTAGE

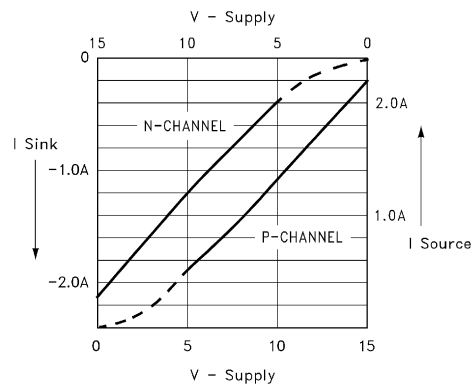

QUIESCENT SUPPLY CURRENT

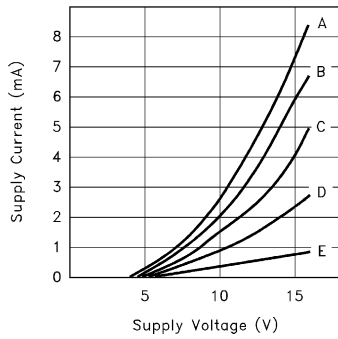

CASE:

Device	Input Level	Curve
EL7202	GND	A
EL7202	GND, V+	B
EL7202	V+	C
EL7212	GND	C
EL7212	GND, V+	D
EL7212	V+	E
EL7222	GND	B
EL7222	GND, V+	C
EL7222	V+	D

"ON" RESISTANCE vs SUPPLY VOLTAGE

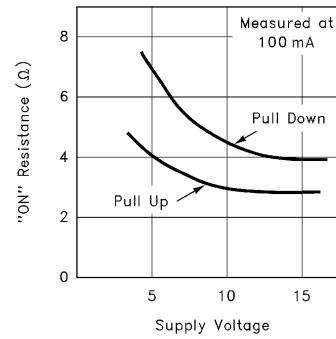

Typical Performance Curves (Continued)

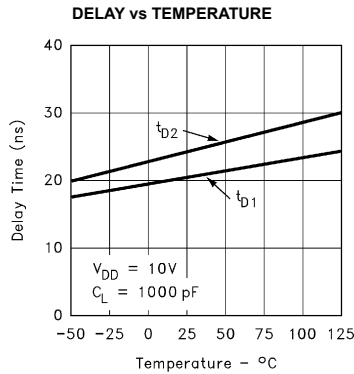
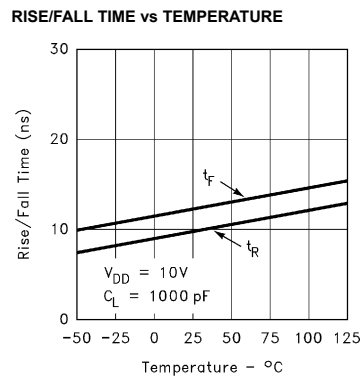
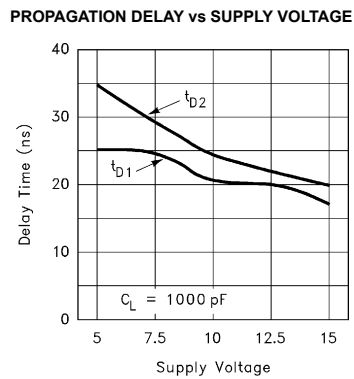
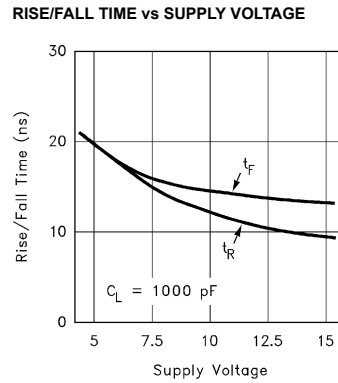
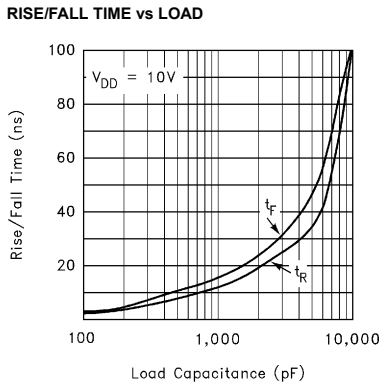
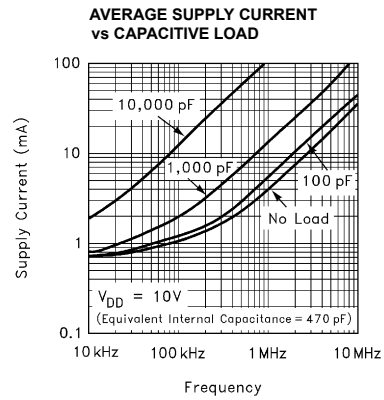
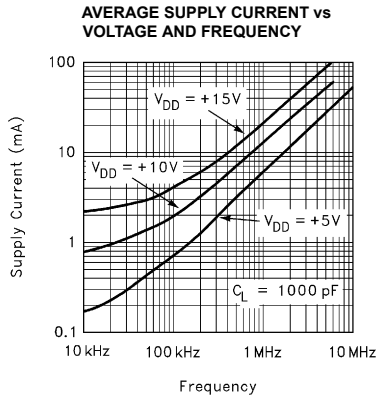

EL7212 Macro Model

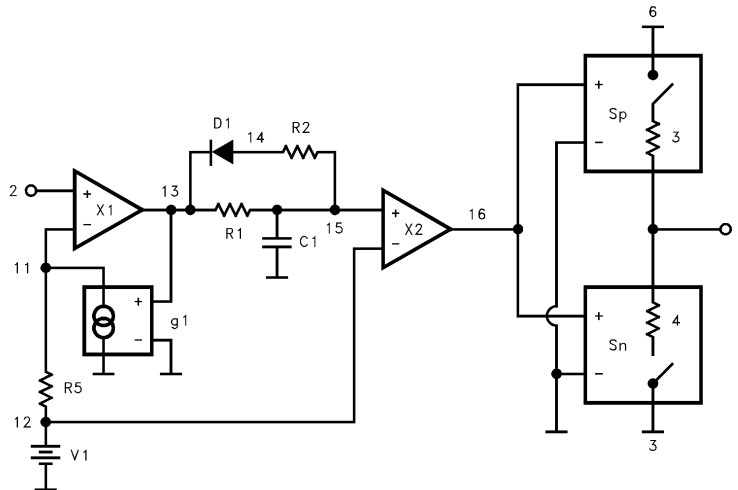

```

**** EL7212 model ****
*           input
*           |   gnd
*           |   |   Vsupply
*           |   |   |   Vout
*           |   |   |   |
.subckt M7212 2 3 6 7
V1 12 3 1.6
R1 13 15 1k
R2 14 15 5k
R5 11 12 100
C1 15 3 43.3 pF
D1 14 13 dmod
X1 13 11 2 3 comp1
X2 16 12 15 3 comp1
sp 6 7 16 3 spmod
sn 7 3 16 3 snmod
g1 11 0 13 0 938µ
.model dmod d
.model spmod vswitch ron3 roff2meg von1 voff1.5
.model snmod vswitch ron4 roff2meg von3 voff2
.ends M7212
.subckt comp1 out inp inm vss
e1 out vss table { (v(inp) v(inm))* 5000} (0,0) (3.2,3.2)
Rout out vss 10meg
Rinp inp vss 10meg
Rinm inm vss 10meg
.ends comp1
    
```

Small Outline Package Family (SO)

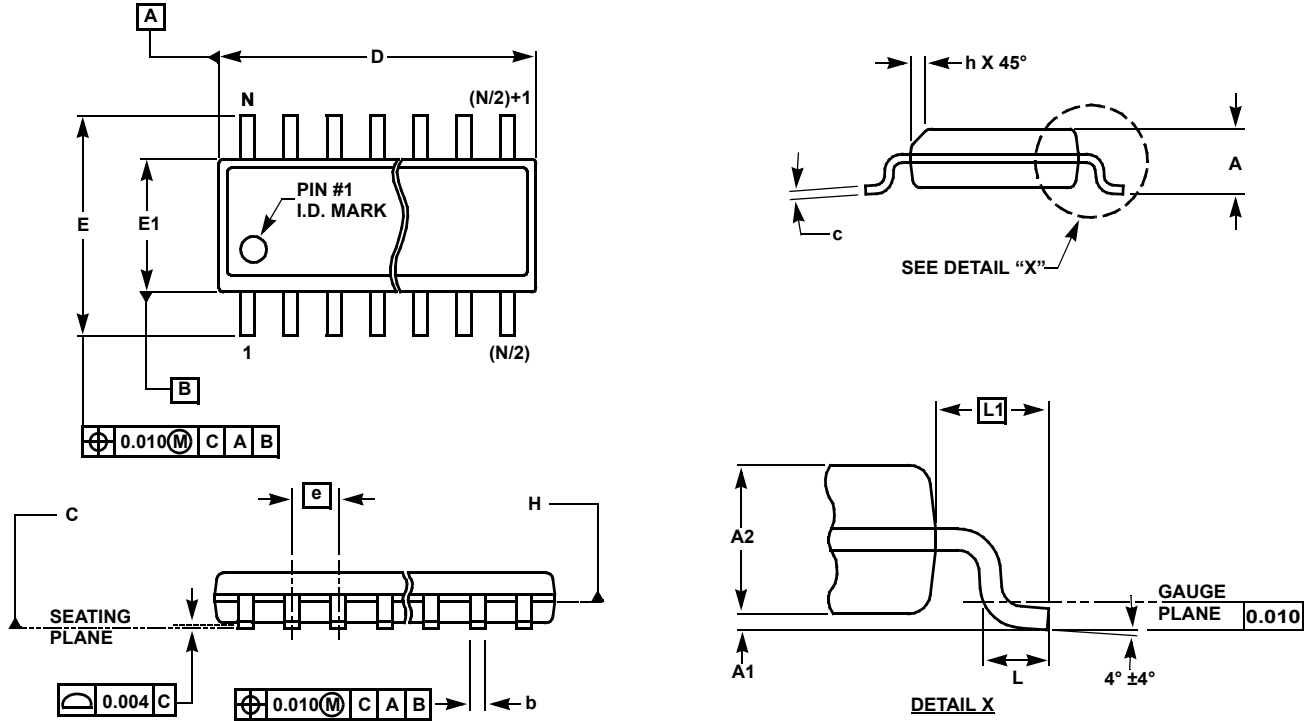

MDP0027

SMALL OUTLINE PACKAGE FAMILY (SO)

SYMBOL	SO-8	SO-14	SO16 (0.150")	SO16 (0.300") (SOL-16)	SO20 (SOL-20)	SO24 (SOL-24)	SO28 (SOL-28)	TOLERANCE	NOTES
A	0.068	0.068	0.068	0.104	0.104	0.104	0.104	MAX	-
A1	0.006	0.006	0.006	0.007	0.007	0.007	0.007	± 0.003	-
A2	0.057	0.057	0.057	0.092	0.092	0.092	0.092	± 0.002	-
b	0.017	0.017	0.017	0.017	0.017	0.017	0.017	± 0.003	-
c	0.009	0.009	0.009	0.011	0.011	0.011	0.011	± 0.001	-
D	0.193	0.341	0.390	0.406	0.504	0.606	0.704	± 0.004	1, 3
E	0.236	0.236	0.236	0.406	0.406	0.406	0.406	± 0.008	-
E1	0.154	0.154	0.154	0.295	0.295	0.295	0.295	± 0.004	2, 3
e	0.050	0.050	0.050	0.050	0.050	0.050	0.050	Basic	-
L	0.025	0.025	0.025	0.030	0.030	0.030	0.030	± 0.009	-
L1	0.041	0.041	0.041	0.056	0.056	0.056	0.056	Basic	-
h	0.013	0.013	0.013	0.020	0.020	0.020	0.020	Reference	-
N	8	14	16	16	20	24	28	Reference	-

Rev. L 2/01

NOTES:

1. Plastic or metal protrusions of 0.006" maximum per side are not included.
2. Plastic interlead protrusions of 0.010" maximum per side are not included.
3. Dimensions "D" and "E1" are measured at Datum Plane "H".
4. Dimensioning and tolerancing per ASME Y14.5M-1994

Plastic Dual-In-Line Packages (PDIP)

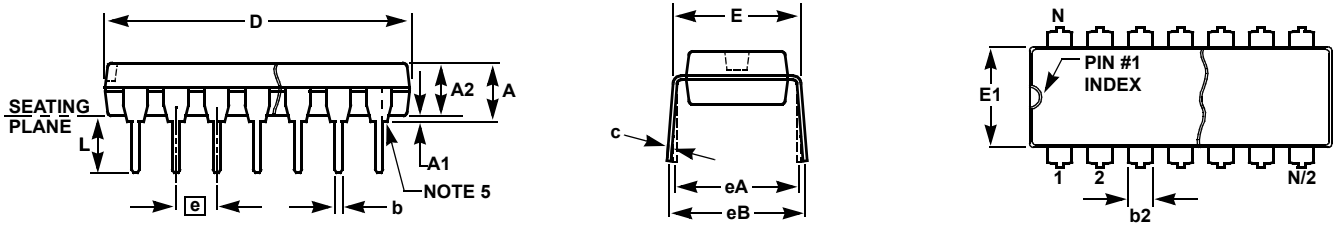

**MDP0031
PLASTIC DUAL-IN-LINE PACKAGE**

SYMBOL	PDIP8	PDIP14	PDIP16	PDIP18	PDIP20	TOLERANCE	NOTES
A	0.210	0.210	0.210	0.210	0.210	MAX	
A1	0.015	0.015	0.015	0.015	0.015	MIN	
A2	0.130	0.130	0.130	0.130	0.130	±0.005	
b	0.018	0.018	0.018	0.018	0.018	±0.002	
b2	0.060	0.060	0.060	0.060	0.060	+0.010/-0.015	
c	0.010	0.010	0.010	0.010	0.010	+0.004/-0.002	
D	0.375	0.750	0.750	0.890	1.020	±0.010	1
E	0.310	0.310	0.310	0.310	0.310	+0.015/-0.010	
E1	0.250	0.250	0.250	0.250	0.250	±0.005	2
e	0.100	0.100	0.100	0.100	0.100	Basic	
eA	0.300	0.300	0.300	0.300	0.300	Basic	
eB	0.345	0.345	0.345	0.345	0.345	±0.025	
L	0.125	0.125	0.125	0.125	0.125	±0.010	
N	8	14	16	18	20	Reference	

Rev. B 2/99

NOTES:

1. Plastic or metal protrusions of 0.010" maximum per side are not included.
2. Plastic interlead protrusions of 0.010" maximum per side are not included.
3. Dimensions E and eA are measured with the leads constrained perpendicular to the seating plane.
4. Dimension eB is measured with the lead tips unconstrained.
5. 8 and 16 lead packages have half end-leads as shown.

© Copyright Intersil Americas LLC 2003-2006. All Rights Reserved.
All trademarks and registered trademarks are the property of their respective owners.

For additional products, see www.intersil.com/en/products.html

Intersil products are manufactured, assembled and tested utilizing ISO9001 quality systems as noted in the quality certifications found at www.intersil.com/en/support/qualandreliability.html

Intersil products are sold by description only. Intersil may modify the circuit design and/or specifications of products at any time without notice, provided that such modification does not, in Intersil's sole judgment, affect the form, fit or function of the product. Accordingly, the reader is cautioned to verify that datasheets are current before placing orders. Information furnished by Intersil is believed to be accurate and reliable. However, no responsibility is assumed by Intersil or its subsidiaries for its use; nor for any infringements of patents or other rights of third parties which may result from its use. No license is granted by implication or otherwise under any patent or patent rights of Intersil or its subsidiaries.

For information regarding Intersil Corporation and its products, see www.intersil.com

Mouser Electronics

Authorized Distributor

Click to View Pricing, Inventory, Delivery & Lifecycle Information:

[Renesas Electronics:](#)

[EL7202CSZ](#) [EL7202CSZ-T13](#) [EL7202CSZ-T7](#) [EL7212CNZ](#) [EL7212CSZ](#) [EL7212CSZ-T13](#) [EL7212CSZ-T7](#)
[EL7222CSZ](#) [EL7222CSZ-T13](#) [EL7222CSZ-T7](#)