

Data Sheet



Description

The HSMx-C280 ChipLEDs are designed to 0402 (1.0 x 0.5 mm) industry standard footprint. They are extremely small in size and the low 0.4 mm height makes them very suitable for application in small portable hand held devices where real estate is a premium.

Six different colors are available: green, red, yellow, amber, and deep red. All parts are color and intensity binned except red color. They come in 8 mm paper tape on a 7 inch diameter reel with 4000 units per reel which makes them compatible for automatic placement.

Device Selection Guide

AS AllInGaP

Product Number	Color	Package Description
HSMA-C280	Amber	Untinted, Diffused
HSMC-C280	Red	Untinted, Diffused
HSMT-C280	Deep Red	Untinted, Diffused

GaP

Product Number	Color	Package Description
HSMG-C280	Green	Untinted, Diffused
HSMS-C280	HER	Untinted, Diffused
HSMY-C280	Yellow	Untinted, Diffused

Features

- Extremely small size (1.0 x 0.5 x 0.4 mm)
- 0402 industry standard footprint
- Diffused optics
- Operating temperature range of -40°C to $+85^{\circ}\text{C}$
- Compatible with IR soldering
- Available in 6 colors
- Available in 8 mm paper tape on 7" diameter reel
- Reel sealed in zip locked moisture barrier bags

Applications

- LCD backlighting
- Push button backlighting
- Front panel indicator
- Symbol backlighting
- Keypad backlighting

CAUTION: HSMx-C280 LEDs are Class 1A ESD sensitive per JESD22-A114C.01. Please observe appropriate precautions during handling and processing. Refer to Application Note AN-1142 for additional details.

Package Dimensions

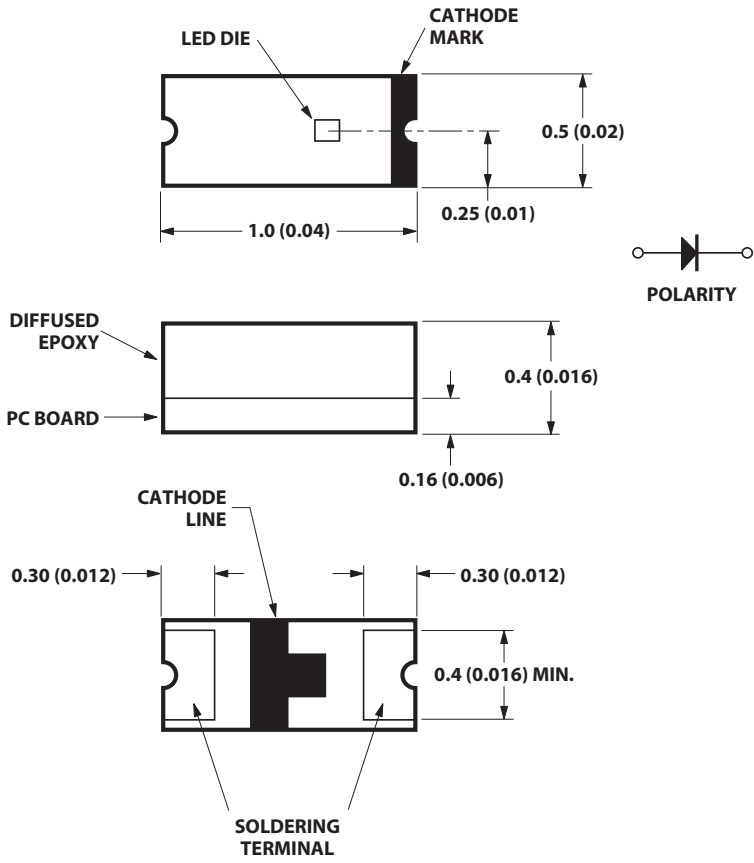

NOTES:

1. ALL DIMENSIONS IN MILLIMETERS (INCHES).
2. TOLERANCE IS ± 0.1 mm (± 0.004 IN.) UNLESS OTHERWISE SPECIFIED.

Absolute Maximum Ratings at $T_A = 25^\circ\text{C}$

Parameter	HSMA/C/T-C280	HSMG/S/Y-C280	Units
DC Forward Current ^[1]	25	20	mA
Power Dissipation	60	52	mW
Reverse Voltage ($I_R = 100\ \mu\text{A}$)	5	5	V
LED Junction Temperature	95	95	$^\circ\text{C}$
Operating Temperature Range	-40 to +85	-40 to +85	$^\circ\text{C}$
Storage Temperature Range	-40 to +85	-40 to +85	$^\circ\text{C}$
Soldering Temperature	See IR soldering profile (Figure 6 & 7)		

Notes:

1. Derate linearly as shown in Figure 4.

Electrical Characteristics at $T_A = 25^\circ\text{C}$

Part Number	Forward Voltage V_F (Volts) @ $I_F = 20\ \text{mA}$		Reverse Breakdown V_R (Volts) @ $I_R = 100\ \mu\text{A}$	Capacitance C (pF), $V_F = 0$, $f = 1\ \text{MHz}$	Thermal Resistance $R_{\theta J-PIN}$ ($^\circ\text{C}/\text{W}$)
	Typ.	Max.	Min.	Typ.	Typ.
HSMA-C280	1.9	2.4	5	11	300
HSMC-C280	1.9	2.4	5	15	300
HSMT-C280	1.9	2.4	5	45	300
HSMG-C280	2.2	2.6	5	9	250
HSMS-C280	2.1	2.6	5	5	250
HSMY-C280	2.1	2.6	5	6	250

Optical Characteristics at $T_A = 25^\circ\text{C}$

Part Number	Color	Luminous Intensity I_V (mcd) @ $20\ \text{mA}$ ^[1]		Peak Wavelength λ_{peak} (nm)	Color, Dominant Wavelength λ_d ^[2] (nm)	Viewing Angle $2\ \theta_{1/2}$ Degrees ^[3]	Luminous Efficacy η_V (lm/w)
		Min.	Typ.	Typ.	Typ.	Typ.	Typ.
HSMA-C280	AS Amber	28.5	90	595	592	130	480
HSMC-C280	AS Red	28.5	90	637	626	130	155
HSMT-C280	AS Deep Red	11.2	30	660	639	130	70
HSMG-C280	GaP Green	4.5	15	570	572	130	595
HSMS-C280	HER	2.8	10	630	626	130	145
HSMY-C280	GaP Yellow	2.8	8	589	586	130	500

Notes:

1. The luminous intensity, I_V , is measured at the peak of the spatial radiation pattern which may not be aligned with the mechanical axis of the lamp package.
2. The dominant wavelength, λ_d , is derived from the CIE Chromatically Diagram and represents the perceived color of the device.
3. $\theta_{1/2}$ is the off-axis angle where the luminous intensity is 1/2 the peak intensity.

Color Bin Limits^[1]

Green Color Bins ^[1]

Bin ID	Dom. Wavelength (nm)	
	Min.	Max.
A	561.5	564.5
B	564.5	567.5
C	567.5	570.5
D	570.5	573.5
E	573.5	576.5

Tolerance: ± 1 nm.

Yellow/Amber Color Bins ^[1]

Bin ID	Dom. Wavelength (nm)	
	Min.	Max.
A	582.0	584.5
B	584.5	587.0
C	587.0	589.5
D	589.5	592.0
E	592.0	594.5
F	594.5	597.0

Tolerance: ± 1 nm.

Note:

1. Bin categories are established for classification of products. Products may not be available in all categories. Please contact your Avago representative for information on currently available bins.

Light Intensity (Iv) Bin Limits^[1]

Bin ID	Intensity (mcd)	
	Min.	Max.
A	0.11	0.18
B	0.18	0.29
C	0.29	0.45
D	0.45	0.72
E	0.72	1.10
F	1.10	1.80
G	1.80	2.80
H	2.80	4.50
J	4.50	7.20
K	7.20	11.20
L	11.20	18.00
M	18.00	28.50
N	28.50	45.00
P	45.00	71.50
Q	71.50	112.50
R	112.50	180.00
S	180.00	285.00
T	285.00	450.00
U	450.00	715.00
V	715.00	1125.00
W	1125.00	1800.00
X	1800.00	2850.00
Y	2850.00	4500.00

Tolerance: ± 15%

Note:

1. Bin categories are established for classification of products. Products may not be available in all categories. Please contact your Avago representative for information on currently available bins.

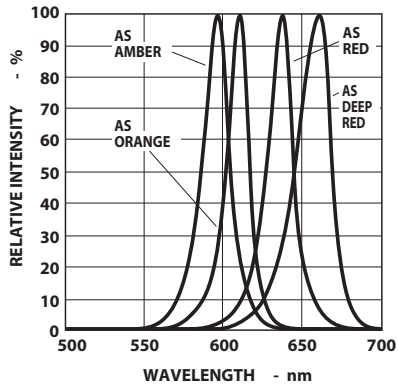

Figure 1a. Relative intensity vs. wavelength.

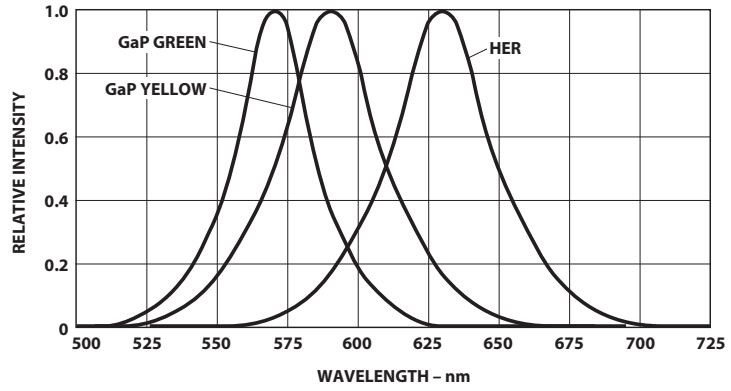

Figure 1b. Relative intensity vs. wavelength.

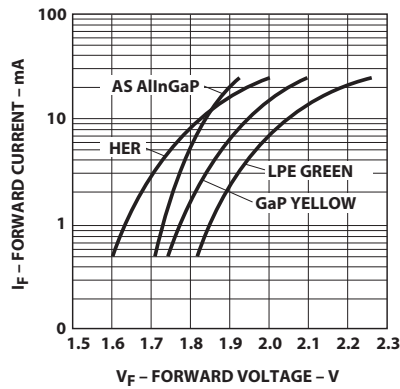

Figure 2. Forward current vs. forward voltage.

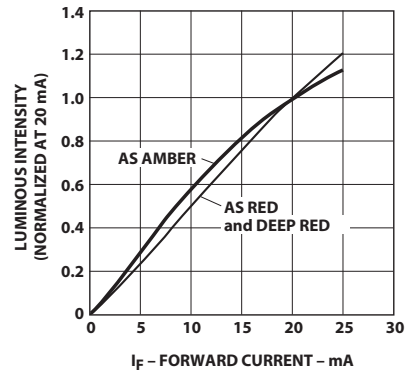
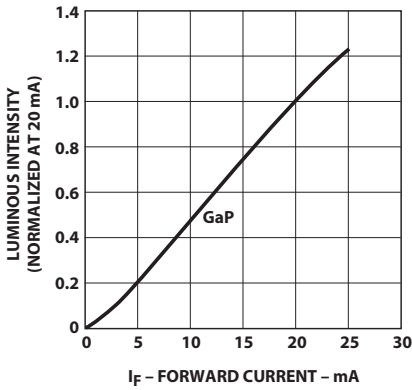

Figure 3. Luminous intensity vs. forward current.

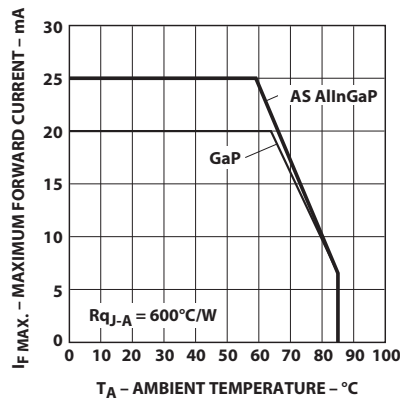

Figure 4. Maximum forward current vs. ambient temperature.

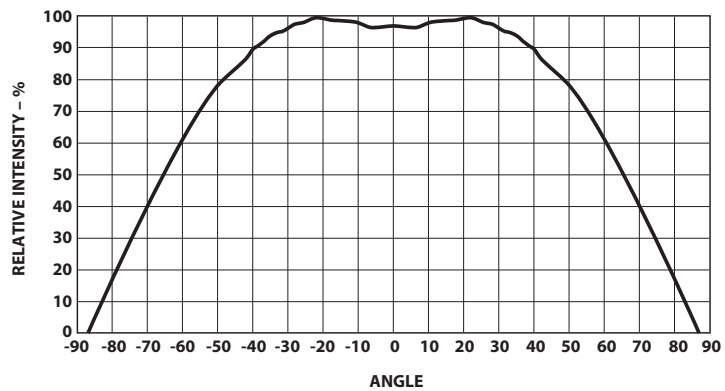

Figure 5. Relative intensity vs. angle.

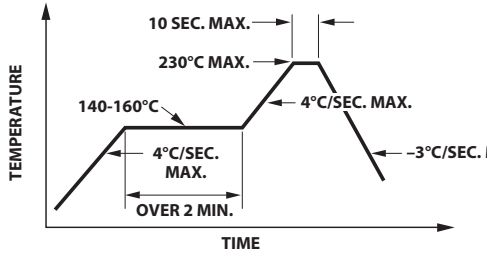

Figure 6. Recommended reflow soldering profile.

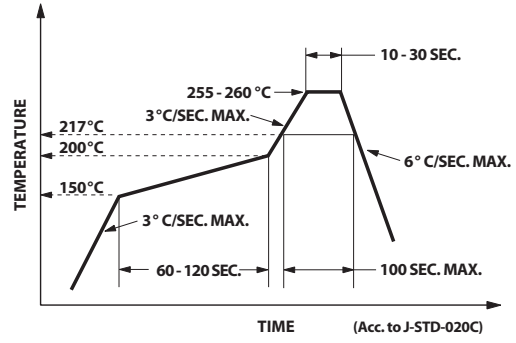

Figure 7. Recommended Pb-free reflow soldering profile.

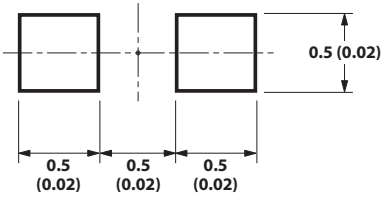

Figure 8. Recommended soldering pattern for HSMx-C280.

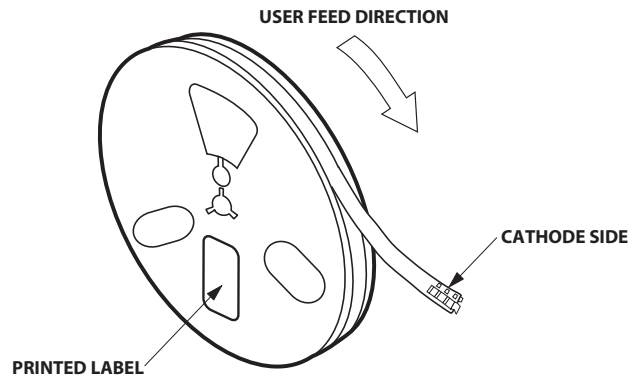

Figure 9. Reeling orientation.

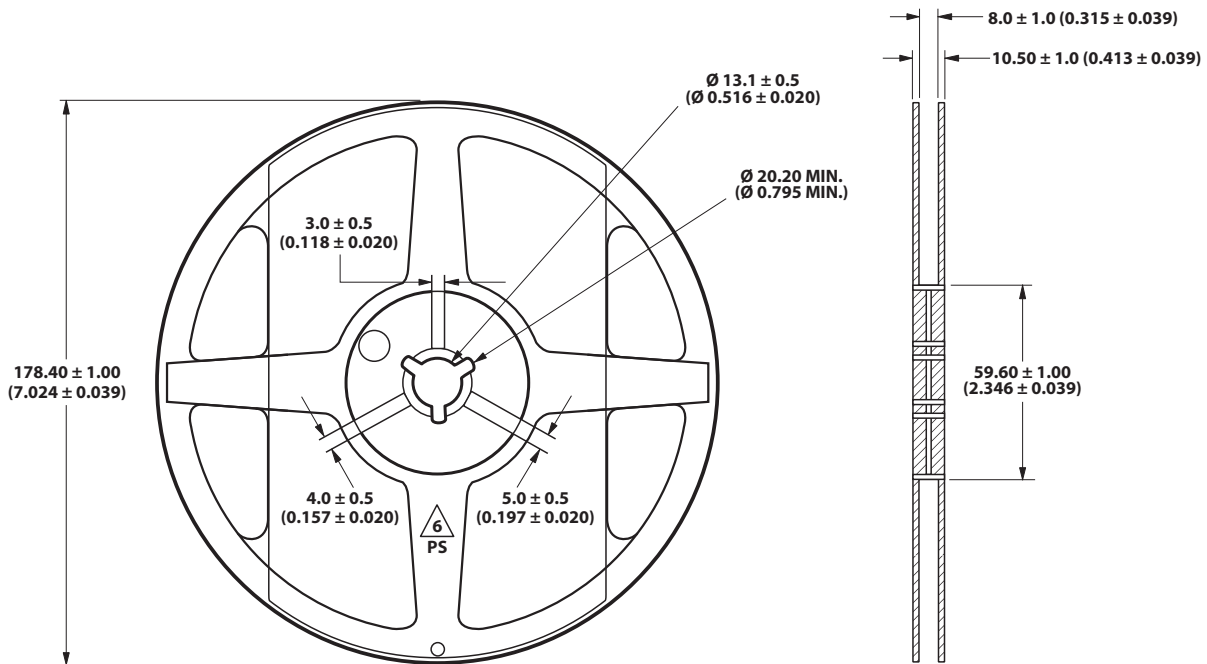

Figure 10. Reel dimensions.

NOTE:
1. ALL DIMENSIONS IN MILLIMETERS (INCHES).

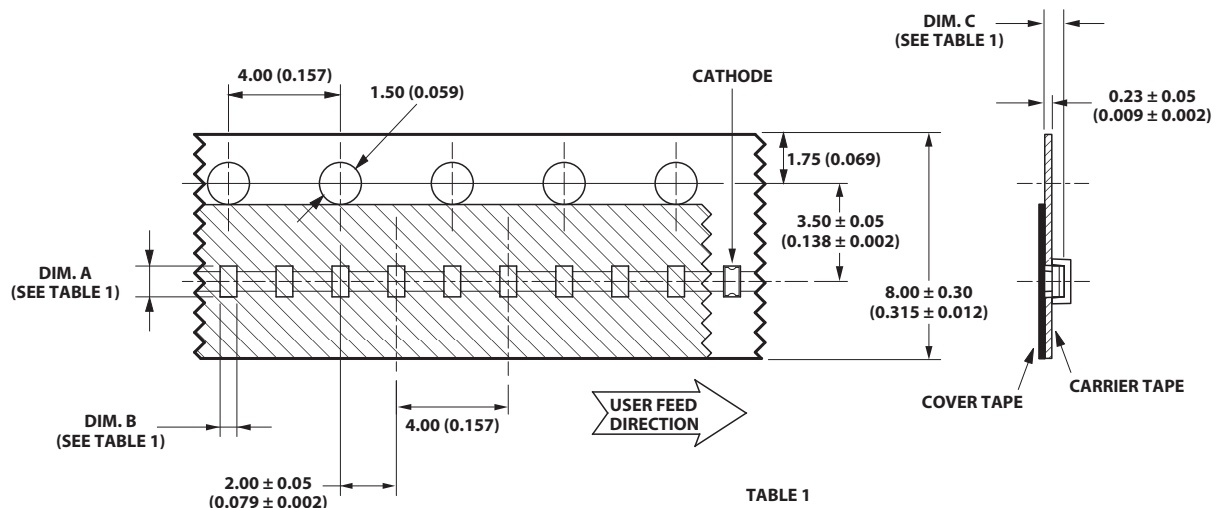
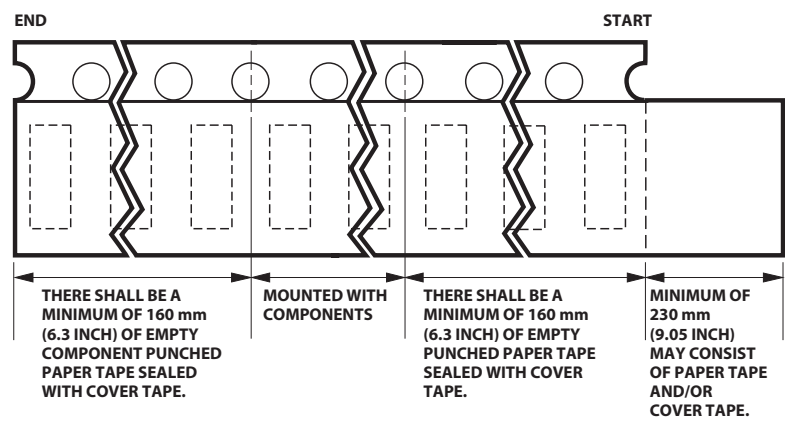

TABLE 1
DIMENSIONS IN MILLIMETERS (INCHES)

PART NUMBER	DIM. A ± 0.10 (± 0.004)	DIM. B ± 0.10 (± 0.004)	DIM. C ± 0.10 (± 0.004)
HSMx-C280 SERIES	1.10 (0.043)	0.60 (0.024)	0.66 (0.026)

Figure 11. Tape dimensions.



- NOTES:
1. ALL DIMENSIONS IN MILLIMETERS (INCHES).
 2. TOLERANCE IS ± 0.1 mm (± 0.004 IN.) UNLESS OTHERWISE SPECIFIED.

Figure 12. Tape leader and trailer dimensions.

Reflow Soldering:

For more information on reflow soldering, refer to Application Note AN-1060, Surface Mounting SMT LED Indicator Components.

Storage Condition: 5 to 30°C @ 60%RH max.

Baking is required before mounting, if:

1. Humidity Indicator Card is > 10% when read at $23 \pm 5^\circ\text{C}$.
2. Device expose to factory conditions <30°C/60%RH more than 672 hours.

Recommended baking condition: $60 \pm 5^\circ\text{C}$ for 20 hours.

For product information and a complete list of distributors, please go to our website: www.avagotech.com

Avago, Avago Technologies, and the A logo are trademarks of Avago Technologies in the United States and other countries.
Data subject to change. Copyright © 2005-2012 Avago Technologies. All rights reserved. Obsoletes 5989-0393EN
AV02-0602EN - February 3, 2012

Avago
TECHNOLOGIES

Mouser Electronics

Authorized Distributor

Click to View Pricing, Inventory, Delivery & Lifecycle Information:

[Avago Technologies:](#)

[HSMA-C280](#) [HSMC-C280](#) [HSMG-C280](#) [HSMY-C280](#)