

AMMC - 5618

6 - 20 GHz Amplifier

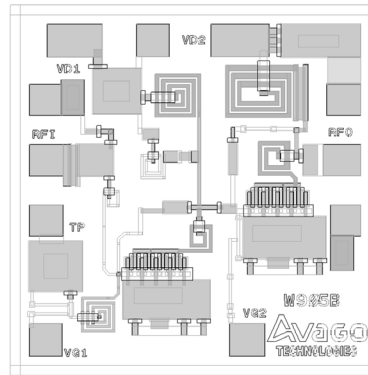

Data Sheet



Chip Size: 920 x 920 μm (36.2 x 36.2 mils)
Chip Size Tolerance: $\pm 10\mu\text{m}$ (± 0.4 mils)
Chip Thickness: $100 \pm 10\mu\text{m}$ (4 ± 0.4 mils)
Pad Dimensions: 80 x 80 μm (3.1 x 3.1 mils or larger)

Description

Avago Technologies' AMMC-5618 6-20 GHz MMIC is an efficient two-stage amplifier designed to be used as a cascadable intermediate gain block for EW applications. In communication systems, it can be used as a LO buffer, or as a transmit driver amplifier. It is fabricated using a PHEMT integrated circuit structure that provides exceptional efficiency and flat gain performance. During typical operation with a single 5-V supply, each gain stage is biased for Class-A operation for optimal power output with minimal distortion. The RF input and output have matching circuitry for use in 50-W environments. The backside of the chip is both RF and DC ground. This helps simplify the assembly process and reduces assembly related performance variations and costs. For improved reliability and moisture protection, the die is passivated at the active areas. The MMIC is a cost effective alternative to hybrid (discrete FET) amplifiers that require complex tuning and assembly processes.

Applications

- Driver/Buffer in microwave communication systems
- Cascadable gain stage for EW systems
- Phased array radar and transmit amplifiers

Features

- Frequency Range: 6 - 20 GHz
- High Gain: 14.5 dB Typical
- Output Power: 19.5 dBm Typical
- Input and Output Return Loss: < -12 dB
- Flat Gain Response: ± 0.3 dB Typical
- Single Supply Bias: 5 V @ 107 mA

AMMC-5618 Absolute Maximum Ratings^[1]

Symbol	Parameters/ Conditions	Units	Min.	Max.
V_{D1}, V_{D2}	Drain Supply Voltage	V		7
V_{G1}	Optional Gate Voltage	V	-5	+1
V_{G2}	Optional Gate Voltage	V	-5	+1
I_{D1}	Drain Supply Current	mA		70
I_{D2}	Drain Supply Current	mA		84
P_{in}	RF Input Power	dBm		20
T_{ch}	Channel Temp.	$^{\circ}\text{C}$		+150
T_b	Operating Backside Temp.	$^{\circ}\text{C}$	-55	
T_{stg}	Storage Temp.	$^{\circ}\text{C}$	-65	+165
T_{max}	Maximum Assembly Temp. (60 sec max)	$^{\circ}\text{C}$		+300

Note:

1. Operation in excess of any one of these conditions may result in permanent damage to this device.

Note: These devices are ESD sensitive. The following precautions are strongly recommended: Ensure that an ESD approved carrier is used when dice are transported from one destination to another. Personal grounding is to be worn at all times when handling these devices.

AMMC-5618 DC Specifications / Physical Properties^[1]

Symbol	Parameters and Test Conditions	Unit	Min.	Typical	Max.
V_{D1}, V_{D2}	Recommended Drain Supply Voltage	V	3	5	7
I_{D1}	First stage Drain Supply Current ($V_{D1} = 5V, V_{G1} = \text{Open or Ground}$)	mA		48	
I_{D2}	Second stage Drain Supply Current ($V_{D2} = 5V, V_{G2} = \text{Open or Ground}$)	mA		59	
$I_{D1} + I_{D2}$	Total Drain Supply Current ($V_{G1} = V_{G2} = \text{Open or Ground}, V_{D1} = V_{D2} = 5V$)	mA		107	140
θ_{ch-b}	Thermal Resistance ^[2] (Backside temperature (T_b) = 25°C)	°C/W		22	

Notes:

1. Backside temperature $T_b = 25^\circ\text{C}$ unless otherwise noted
2. Channel-to-backside Thermal Resistance (θ_{ch-b}) = 32°C/W at $T_{channel} (T_c) = 150^\circ\text{C}$ as measured using infrared microscopy.
Thermal Resistance at backside temperature (T_b) = 25°C calculated from measured data.

AMMC-5618 RF Specifications^[3,5]

($T_b = 25^\circ\text{C}, V_{DD} = 5V, I_{DD} = 107\text{ mA}, Z_0 = 50\ \Omega$)

Symbol	Parameters and Test Conditions	Unit	Min.	Typical	Max.
$ S_{21} ^2$	Small-signal Gain	dB	12.5	14.5	
$\Delta S_{21} ^2$	Small-signal Gain Flatness	dB		± 0.3	
RL_{in}	Input Return Loss	dB	9	12	
RL_{out}	Output Return Loss	dB	9	12	
$ S_{12} ^2$	Isolation	dB	40	45	
P_{-1dB}	Output Power at 1dB Gain Compression @ 20 GHz	dBm	17.5	19.5	
P_{sat}	Saturated Output Power (3dB Gain Compression) @ 20 GHz	dBm		20.5	
OIP3	Output 3rd Order Intercept Point @ 20 GHz	dBm		26	
$\Delta S_{21} / \Delta T$	Temperature Coefficient of Gain ^[4]	dB/°C		-0.023	
NF	Noise Figure @ 20 GHz	dB		4.4	6.5

Notes:

3. 100% on-wafer RF test is done at frequency = 6, 13 and 20 GHz, except as noted.
4. Temperature Coefficient of Gain based on sample test
5. All tested parameters guaranteed with measurement accuracy ±1.5dB for S12, ±1dB for S11, S21, S22, P1dB and ±0.5dB for NF.

AMMC-5618 Typical Performance ($T_{\text{chuck}}=25^{\circ}\text{C}$, $V_{\text{DD}}=5\text{V}$, $I_{\text{DD}}=107\text{mA}$, $Z_o=50\Omega$)

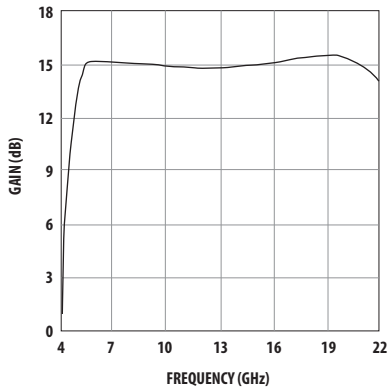

Figure 1. Gain

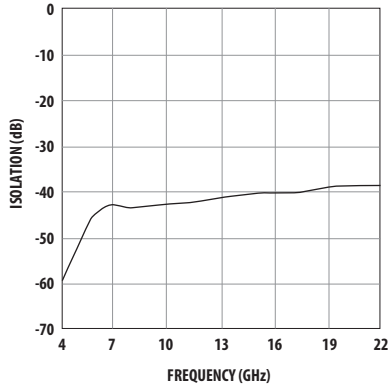

Figure 2. Isolation

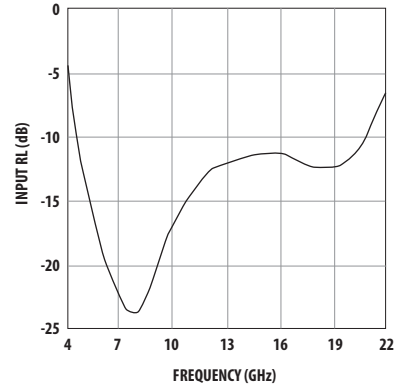

Figure 3. Input Return Loss

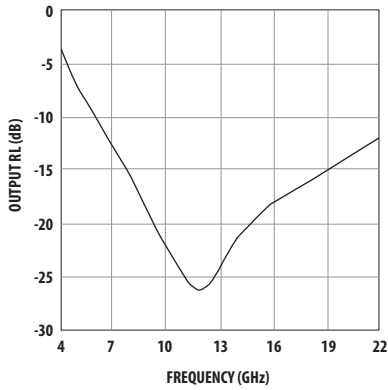

Figure 4. Output Return Loss

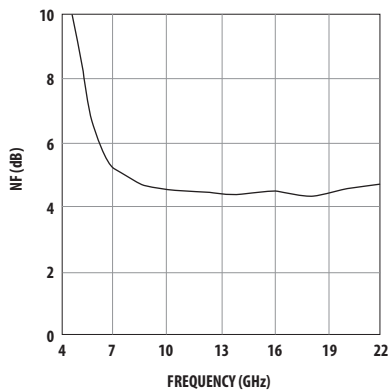

Figure 5. Noise Figure

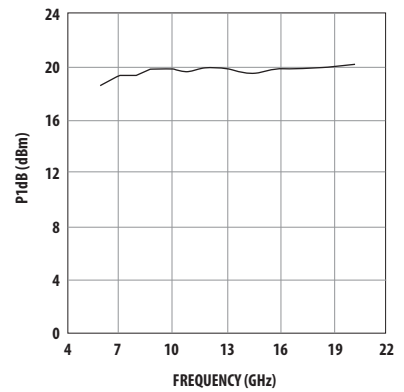

Figure 6. output Power at 1 dB Gain Compression

AMMC-5618 Typical Performance vs. Supply Voltage ($T_b=25^{\circ}\text{C}$, $Z_o=50\Omega$)

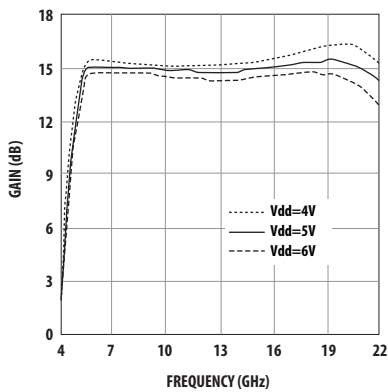

Figure 7. Gain and Voltage

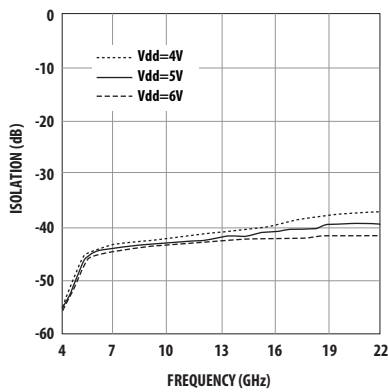

Figure 8. Isolation and Voltage

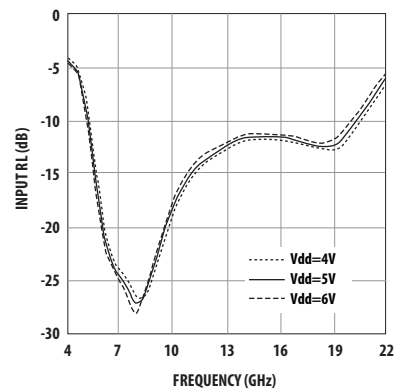

Figure 9. Input Return Loss and Voltage

AMMC-5618 Typical Performance vs. Supply Voltage (cont.) ($T_b=25^\circ\text{C}$, $Z_o=50\Omega$)

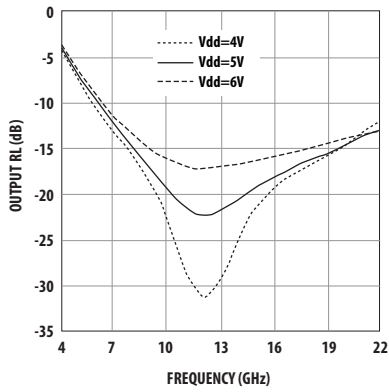

Figure 10. Output Return Loss and Voltage

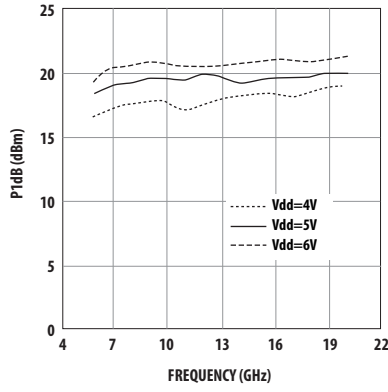

Figure 11. Output Power and Voltage

AMMC-5618 Typical Performance vs. Temperature ($V_{DD}=5\text{V}$, $Z_o=50\Omega$)

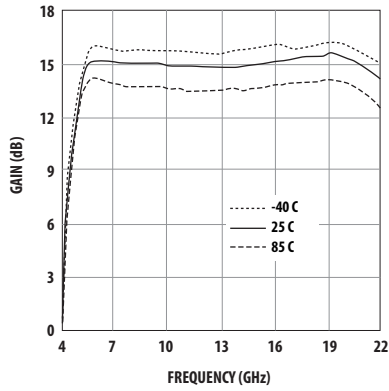

Figure 12. Gain and Temperature

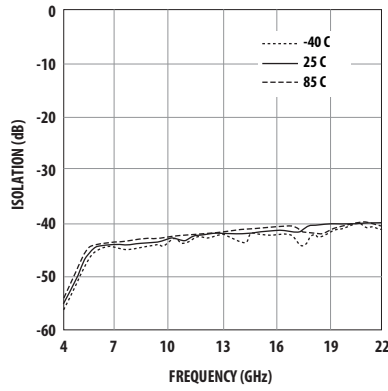

Figure 13. Isolation and Temperature

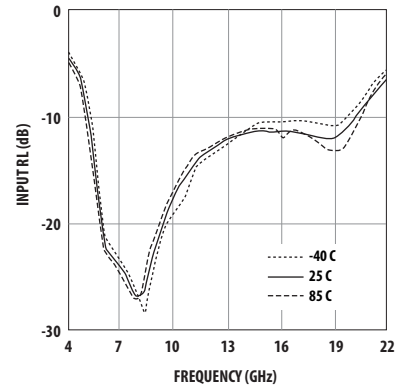

Figure 14. Input Return Loss and Temperature

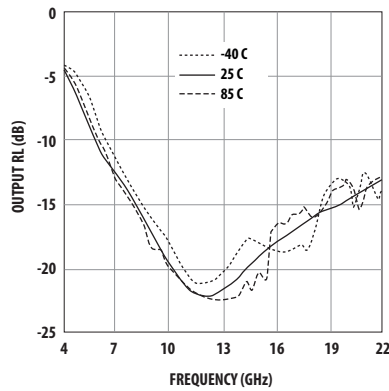

Figure 15. Output Return Loss and Temperature

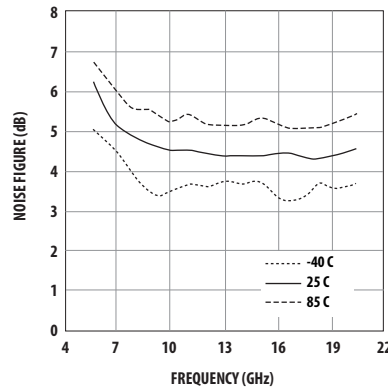

Figure 16. Noise Figure and Temperature

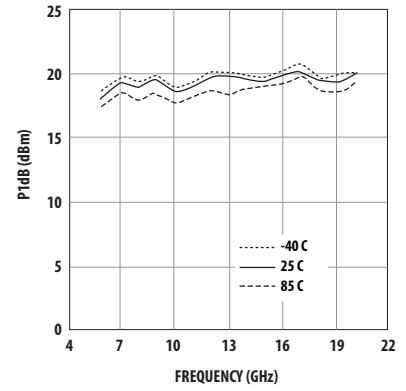

Figure 17. Output Power and Temperature

AMMC-5618 Typical Scattering Parameters^[1] ($T_b=25^\circ\text{C}$, $V_{DD}=5\text{ V}$, $I_{DD}=107\text{ mA}$)

Freq GHz	S11			S21			S12			S22		
	dB	Mag	Phase	dB	Mag	Phase	dB	Mag	Phase	dB	Mag	Phase
2.00	-2.4	0.76	-125	-52.0	0	74	-80.0	0	-134	-0.4	0.95	-77
2.50	-2.9	0.72	-147	-35.4	0.02	-119	-74.0	0	-57	-0.9	0.91	-97
3.00	-3.2	0.69	-166	-19.0	0.11	-102	-69.1	0	-65	-1.6	0.84	-118
3.50	-3.6	0.66	174	-7.4	0.43	-120	-59.1	0	-60	-2.6	0.75	-138
4.00	-4.0	0.63	152	0.8	1.09	-147	-57.7	0	-104	-3.8	0.64	-156
4.50	-4.9	0.57	126	7.7	2.43	178	-51.8	0	-113	-5.3	0.55	-173
5.00	-7.3	0.43	94	12.5	4.2	138	-48.8	0	-142	-6.9	0.45	172
5.50	-12.7	0.23	67	14.7	5.41	94	-45.7	0.01	-170	-8.6	0.37	160
6.00	-19.8	0.1	66	15.1	5.69	60	-44.5	0.01	161	-10.1	0.31	151
6.50	-23.6	0.07	85	15.1	5.69	34	-44.6	0.01	142	-11.3	0.27	141
7.00	-24.7	0.06	87	15.0	5.64	13	-44.3	0.01	127	-12.6	0.23	130
7.50	-26.4	0.05	68	15.0	5.61	-5	-44.0	0.01	115	-13.9	0.2	120
8.00	-28.2	0.04	28	14.9	5.59	-22	-43.9	0.01	103	-15.3	0.17	109
8.50	-26.3	0.05	-23	14.9	5.57	-37	-43.6	0.01	95	-16.7	0.15	98
9.00	-22.8	0.07	-55	14.9	5.55	-51	-43.3	0.01	86	-18.2	0.12	87
9.50	-19.9	0.1	-74	14.8	5.52	-65	-43.2	0.01	77	-19.7	0.1	74
10.00	-17.7	0.13	-88	14.8	5.49	-77	-43.1	0.01	70	-21.4	0.09	60
10.50	-16.1	0.16	-100	14.7	5.45	-90	-42.9	0.01	63	-22.8	0.07	43
11.00	-14.8	0.18	-110	14.7	5.43	-101	-42.8	0.01	57	-24.3	0.06	23
11.50	-13.9	0.2	-120	14.7	5.41	-113	-42.5	0.01	52	-25.1	0.06	1
12.00	-13.2	0.22	-128	14.6	5.38	-124	-42.5	0.01	45	-25.1	0.06	-22
12.50	-12.6	0.23	-136	14.6	5.37	-134	-42.3	0.01	40	-24.5	0.06	-44
13.00	-12.2	0.25	-143	14.6	5.37	-145	-42.1	0.01	34	-23.3	0.07	-60
13.50	-11.9	0.26	-151	14.6	5.38	-155	-41.9	0.01	31	-22.2	0.08	-73
14.00	-11.6	0.26	-159	14.7	5.4	-166	-41.7	0.01	24	-21.3	0.09	-85
14.50	-11.5	0.27	-166	14.7	5.42	-176	-41.6	0.01	19	-20.7	0.09	-95
15.00	-11.4	0.27	-174	14.7	5.46	174	-41.4	0.01	15	-19.8	0.1	-105
15.50	-11.4	0.27	177	14.8	5.49	163	-41.3	0.01	9	-19.1	0.11	-113
16.00	-11.5	0.27	168	14.9	5.54	153	-41.1	0.01	3	-18.4	0.12	-121
16.50	-11.7	0.26	157	14.9	5.58	142	-40.8	0.01	0	-17.7	0.13	-126
17.00	-11.9	0.25	146	15.0	5.63	131	-40.8	0.01	-7	-17.2	0.14	-132
17.50	-12.2	0.25	132	15.1	5.66	120	-40.8	0.01	-12	-16.7	0.15	-138
18.00	-12.4	0.24	116	15.1	5.71	109	-40.5	0.01	-16	-16.2	0.16	-143
18.50	-12.4	0.24	98	15.2	5.75	97	-40.4	0.01	-23	-15.8	0.16	-148
19.00	-12.2	0.25	77	15.2	5.75	85	-40.3	0.01	-29	-15.4	0.17	-154
19.50	-11.5	0.27	56	15.2	5.73	73	-40.1	0.01	-35	-14.9	0.18	-158
20.00	-10.5	0.3	34	15.0	5.65	60	-39.9	0.01	-42	-14.6	0.19	-163
20.50	-9.2	0.35	14	14.8	5.51	46	-39.9	0.01	-48	-14.0	0.2	-166
21.00	-7.9	0.4	-5	14.5	5.31	33	-40.0	0.01	-55	-13.8	0.2	-172
21.50	-6.7	0.46	-21	14.1	5.05	19	-39.8	0.01	-63	-13.5	0.21	-176
22.00	-5.7	0.52	-36	13.5	4.72	5	-40.3	0.01	-72	-13.1	0.22	179

Note:

1. Data obtained from on-wafer measurements

Biasing and Operation

The AMMC-5618 is normally biased with a single positive drain supply connected to both V_{D1} and V_{D2} bond pads as shown in Figure 19(a). The recommended supply voltage is 3 to 5 V.

No ground wires are required because all ground connections are made with plated through-holes to the backside of the device.

Gate bias pads (V_{G1} & V_{G2}) are also provided to allow adjustments in gain, RF output power, and DC power dissipation, if necessary. No connection to the gate pad is needed for single drain-bias operation. However, for custom applications, the DC current flowing through the input and/or output gain stage may be adjusted by applying a voltage to the gate bias pad(s) as shown in Figure 19(b). A negative gate-pad voltage will decrease the drain current. The gate-pad voltage is approximately zero volt during operation with no DC gate supply. Refer to the Absolute Maximum Ratings table for allowed DC and thermal conditions.

Assembly Techniques

The backside of the AMMC-5618 chip is RF ground. For microstripline applications, the chip should be attached directly to the ground plane (e.g., circuit carrier or heat-sink) using electrically conductive epoxy ^[1,2].

For best performance, the topside of the MMIC should be brought up to the same height as the circuit surrounding it. This can be accomplished by mounting a gold plated metal shim (same length and width as the MMIC) under the chip, which is of the correct thickness to make the chip and adjacent circuit coplanar.

The amount of epoxy used for chip and or shim attachment should be just enough to provide a thin fillet around the bottom perimeter of the chip or shim. The ground plane should be free of any residue that may jeopardize electrical or mechanical attachment.

The location of the RF bond pads is shown in Figure 20. Note that all the RF input and output ports are in a Ground-Signal-Ground configuration.

RF connections should be kept as short as reasonable to minimize performance degradation due to undesirable series inductance. A single bond wire is sufficient for signal connections, however double-bonding with 0.7 mil gold wire or the use of gold mesh is recommended for best performance, especially near the high end of the frequency range.

Thermosonic wedge bonding is the preferred method for wire attachment to the bond pads. Gold mesh can be attached using a 2 mil round tracking tool and a tool force of approximately 22 grams with an ultrasonic power of roughly 55dB for a duration of 76 ± 8 mS. A guided wedge at an ultrasonic power level of 64 dB can be used for the 0.7 mil wire. The recommended wire bond stage temperature is $150 \pm 2^\circ$ C.

Caution should be taken to not exceed the Absolute Maximum Rating for assembly temperature and time.

The chip is 100 μ m thick and should be handled with care. This MMIC has exposed air bridges on the top surface and should be handled by the edges or with a custom collet (do not pick up die with vacuum on die center.)

This MMIC is also static sensitive and ESD handling precautions should be taken.

Notes:

1. Ablebond 84-1 LM1 silver epoxy is recommended.
2. Eutectic attach is not recommended and may jeopardize reliability of the device.

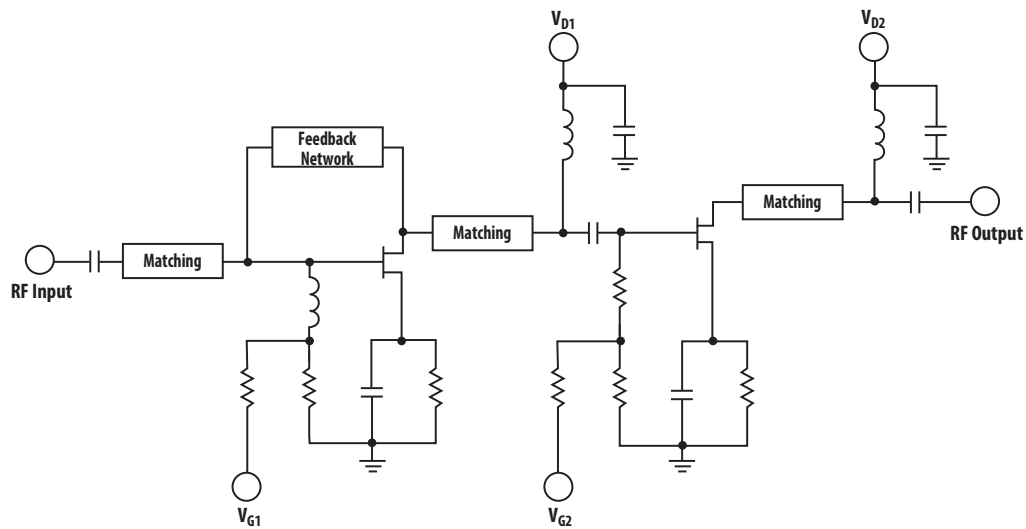

Figure 18. AMMC - 5618 Schematic

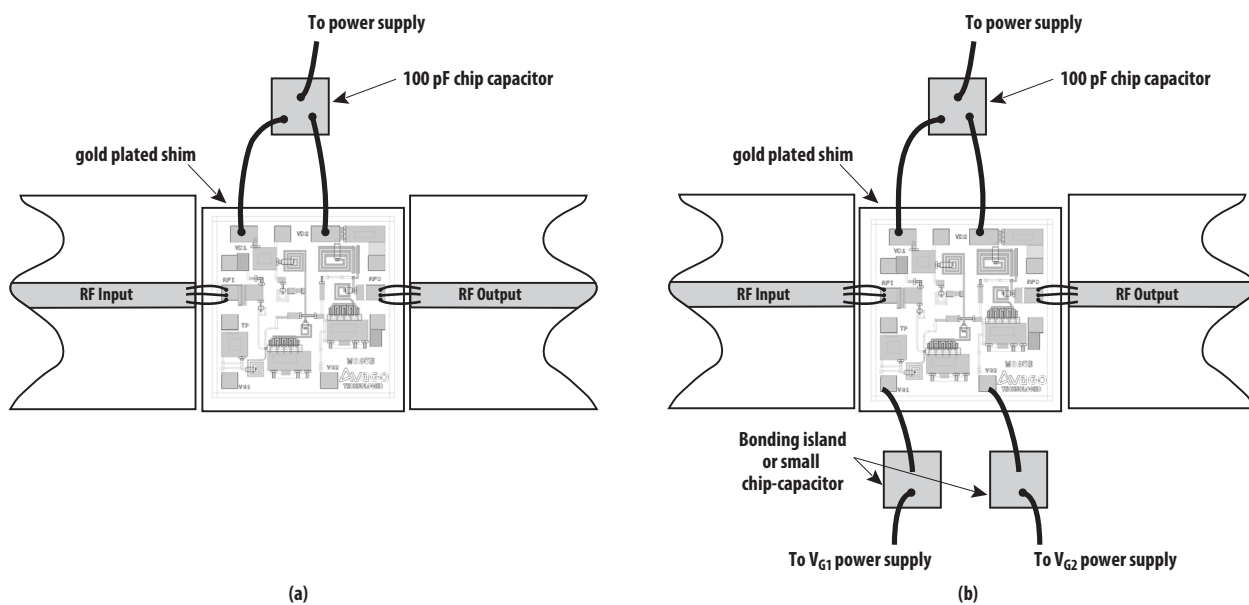
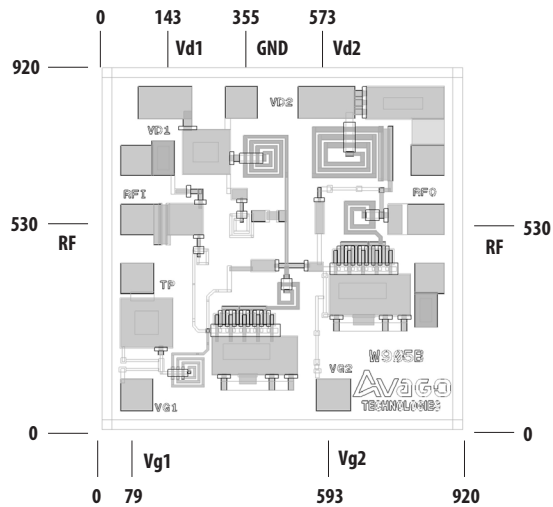

Figure 19. AMMC - 5618 Assembly Diagram



**Figure 20. AMMC - 5618 Bond pad locations
(dimensions in microns)**

Ordering Information:

AMMC-5618-W10 = 10 devices per tray

AMMC-5618-W50 = 50 devices per tray

For product information and a complete list of distributors, please go to our web site: www.avagotech.com

Avago, Avago Technologies, and the A logo are trademarks of Avago Technologies in the United States and other countries. Data subject to change. Copyright © 2005-2013 Avago Technologies. All rights reserved. Obsoletes 5989-3927EN AV02-0070EN - September 26, 2013



Mouser Electronics

Authorized Distributor

Click to View Pricing, Inventory, Delivery & Lifecycle Information:

[Avago Technologies:](#)

[AMMC-5618-W10](#)

[Broadcom Limited:](#)

[AMMC-5618-W50](#)