

IFD89 N-Channel JFET with Diodes

Features

- InterFET [N0014EU Geometry](#)
- Low Noise: 5 nV/√Hz Typical
- Low Leakage: 2pA Typical
- Low Ciss: 2.3pF Typical
- RoHS Compliant
- SMT, TH, and Bare Die Package options.

Applications

- Hearing Aids
- Mini Microphones
- Infrared Detector Amplifiers
- Battery Powered Amplifiers
- High Gain, Low-Noise Amplifiers
- Replacement for IFND89

Description

The -15V high gain, low noise InterFET IFD89 comes in several package options and is optimized for low power audio applications. The integrated back to back diodes offers clamping and additional gate leakage.

SOT353 (SC70-5) Top View

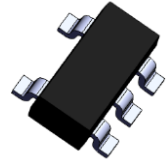
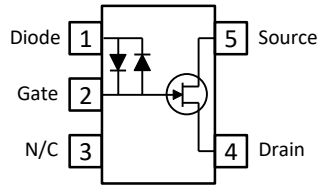

TO-72 Bottom View

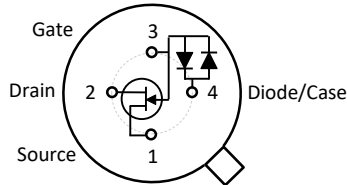

Product Summary

Parameters	IFD89 Min	Unit
BV_{GS} Gate to Source Breakdown Voltage	-15	V
I_{DSS} Drain to Source Saturation Current	0.05	mA
$V_{GS(off)}$ Gate to Source Cutoff Voltage	-0.2	V
G_{FS} Forward Transconductance	0.6	mS

Ordering Information Custom Part and Binning Options Available

Part Number	Description	Case	Packaging
IFD89T72	Through Hole	TO-72	Bulk
IFD89SC5	Surface Mount	SC70-5	Bulk
IFD89SC5TR	7" Tape and Reel: Max 3,000 Pieces 13" Tape and Reel: Max 9,000 Pieces	SC70-5	Minimum 1,000 Pieces Tape and Reel
IFD89COT	Chip Orientated Tray (COT Waffle Pack)	COT	400/Waffle Pack
IFD89CFT	Chip Face-up Tray (CFT Waffle Pack)	CFT	400/Waffle Pack



Disclaimer: It is the Buyers responsibility for designing, validating and testing the end application under all field use cases and extreme use conditions. Guaranteeing the application meets required standards, regulatory compliance, and all safety and security requirements is the responsibility of the Buyer. These resources are subject to change without notice.

Electrical Characteristics

Maximum Ratings (@ $T_A = 25^\circ\text{C}$, Unless otherwise specified)

Parameters	Value	Unit
V_{RGS} Reverse Gate Source and Gate Drain Voltage	-15	V
I_{FG} Continuous Forward Gate Current	10	mA
P_D Continuous Device Power Dissipation	250	mW
P Power Derating	2	mW/ $^\circ\text{C}$
T_J Operating Junction Temperature	-55 to 125	$^\circ\text{C}$
T_{STG} Storage Temperature	-55 to 150	$^\circ\text{C}$

Static Characteristics (@ $T_A = 25^\circ\text{C}$, Unless otherwise specified)

Parameters	Conditions	IFD89		Unit
		Min	Max	
$V_{(BR)GSS}$ Gate to Source Breakdown Voltage	$V_{DS} = 0V, I_G = -1\mu\text{A}$	-15		V
I_{GSS} Gate to Source Reverse Current	$V_{GS} = -10V, V_{DS} = 0V$		-0.10	nA
$V_{GS(OFF)}$ Gate to Source Cutoff Voltage	$V_{DS} = 1.3V, I_D = 1\mu\text{A}$	-0.2	-0.9	V
	$V_{DS} = 3.3V, I_D = 1\mu\text{A}$	-0.2	-2.5	
I_{DSS} Drain to Source Saturation Current	$V_{GS} = 0V, V_{DS} = 0.92V$ (Pulsed)	50	1000	μA
$V_{(BR)Gdiode}$ Gate to Diode Breakdown Voltage +	$I_G = 10\mu\text{A}, V_{DS} = 0V$	0.4	0.8	V
$V_{(BR)Gdiode}$ Gate to Diode Breakdown Voltage -	$I_G = -10\mu\text{A}, V_{DS} = 0V$	-0.4	-0.8	V

Dynamic Characteristics (@ $T_A = 25^\circ\text{C}$, Unless otherwise specified)

Parameters	Conditions	IFD89		Unit
		Min	Max	
$R_{DS(ON)}$ Drain to Source ON Resistance	$V_{DS} \leq 0.1V, I_D \leq 100\mu\text{A}, f = 1\text{kHz}$		3000	Ω
G_{FS} Forward Transconductance	$V_{DS} = 1.3V, V_{GS} = 0V, f = 1\text{kHz}$	0.6	2.25	mS
C_{iss} Input Capacitance	$V_{DS} = 1.3V, V_{GS} = 0V, f = 1\text{MHz}$		5	pF
e_n Equivalent Circuit Input Noise Voltage	$V_{DS} = 1.3V, V_{GS} = 0V, f = 100\text{Hz}$		12	nV/ $\sqrt{\text{Hz}}$

TO-72 Mechanical and Layout Data

Package Outline Data

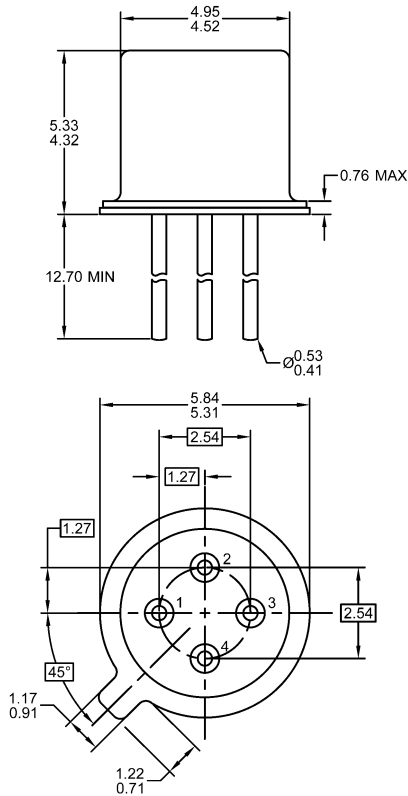

1. All linear dimensions are in millimeters.
2. Four leaded device. Not all leads are shown in drawing views.
3. Package weight approximately 0.31 grams
4. Bulk product is shipped in standard ESD shipping material
5. Refer to JEDEC standards for additional information.

Suggested Through-Hole Layout

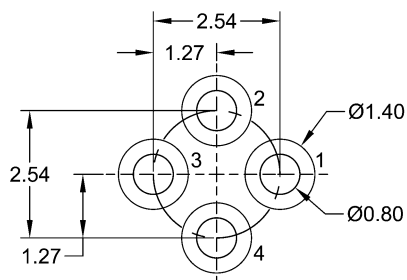

1. All linear dimensions are in millimeters.
2. The suggested land pattern dimensions have been provided as a straight lead reference only. A more robust pattern may be desired for wave soldering and/or bent lead configurations.

SC70-5 (SOT353) Mechanical and Layout Data

Package Outline Data

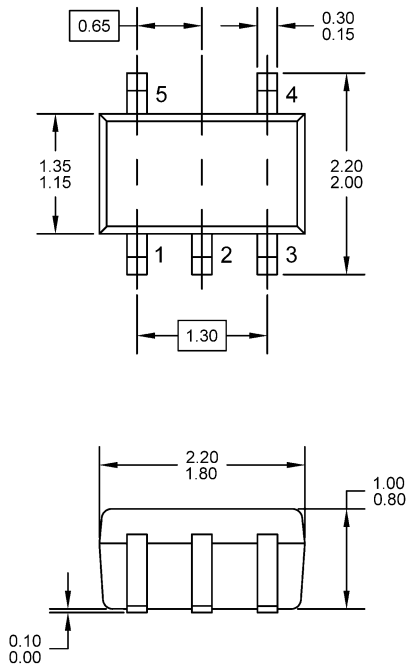

1. All linear dimensions are in millimeters.
2. Package weight approximately 0.07 grams
3. Molded plastic case UL 94V-0 rated
4. For Tape and Reel specifications refer to InterFET CTC-021 Tape and Reel Specification, Document number: IF39002
5. Bulk product is shipped in standard ESD shipping material
6. Refer to JEDEC standards for additional information.

Suggested Pad Layout

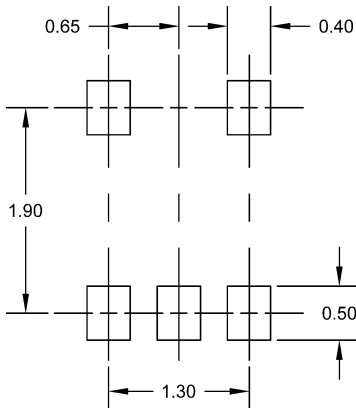

1. All linear dimensions are in millimeters.
2. The suggested land pattern dimensions have been provided for reference only. A more robust pattern may be desired for wave soldering.

Mouser Electronics

Authorized Distributor

Click to View Pricing, Inventory, Delivery & Lifecycle Information:

[InterFET:](#)

[IFND89](#) [IFND89-TR](#) [SMPD89](#)