

SERIES: CP40 | **DESCRIPTION:** PELTIER MODULE

FEATURES

- solid state device
- precise temperature control
- quiet operation

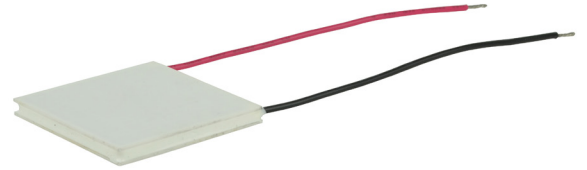

MODEL

MODEL	input voltage ¹ max (Vdc)	input current ² max (A)	output Qmax ³		output ΔTmax ⁴	
			T _n =27°C (W)	T _n =50°C (W)	T _n =27°C (°C)	T _n =50°C (°C)
CP40136	3.8	4.0	8.1	9.0	66	72
CP40236	8.6	4.0	18.7	21.8	66	72
CP40336	15.4	4.0	33.4	37.3	66	72
CP40147	2.1	4.0	4.2	4.6	68	75
CP40247	3.8	4.0	7.5	8.3	68	75
CP40301547	4.2	4.0	8.4	9.2	68	75
CP40347	8.6	4.0	19.6	21.6	68	75
CP40447	15.4	4.0	32	35.2	68	75

- Notes:
1. Maximum voltage at ΔT max and T_n=27°C
 2. Maximum current to achieve ΔT max
 3. Maximum heat absorbed at cold side occurs at I_{max}, V_{max}, and ΔT=0°C
 4. Maximum temperature difference occurs at I_{max}, V_{max}, and Q=0W (ΔT max measured in a vacuum at 1.3 Pa)

PART NUMBER KEY

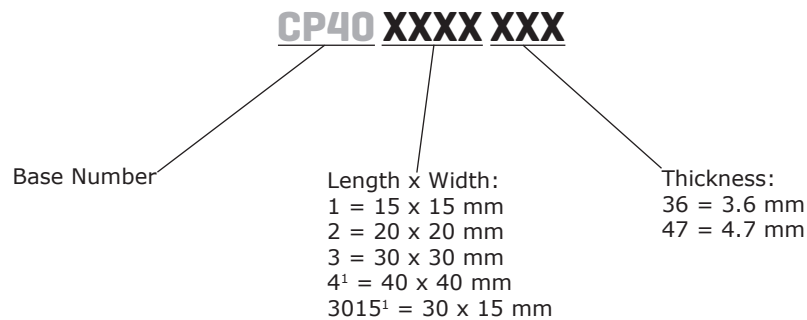

- Notes:
1. Only available in 4.7 mm thickness

SPECIFICATIONS

parameter	conditions/description	min	typ	max	units
internal resistance ¹	CP40136	0.72	0.80	0.88	Ω
	CP40236	1.8	2.0	2.2	Ω
	CP40336	3.15	3.5	3.85	Ω
	CP40147	0.378	0.42	0.462	Ω
	CP40247	0.693	0.77	0.847	Ω
	CP40301547	0.783	0.87	0.957	Ω
	CP40347	1.584	1.76	1.936	Ω
	CP40447	2.835	3.15	3.465	Ω
solder melting temperature	connection between thermoelectric pairs	138			°C
assembly compression	3.6 mm models			0.98	MPa
	4.7 mm models			1	MPa
hot side plate				80	°C
RoHS	2011/65/EU				

Note: 1. Measured by AC 4-terminal method at 25°C

MECHANICAL DRAWING

units: mm

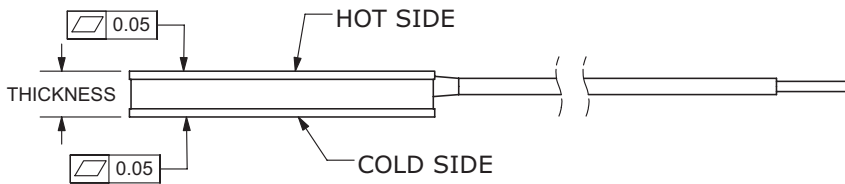

	MATERIAL	PLATING
ceramic plate	96% AL ₂ O ₃	
wire leads (3.6 mm models)	22 AWG	tin
wire leads (4.7 mm models)	20 AWG	tin
sealer	silicon rubber 703 RTV (between cold and hot side plates)	
joint cover	silicon rubber 703 RTV	
marking	P/N & S/N printed on cold side surface	

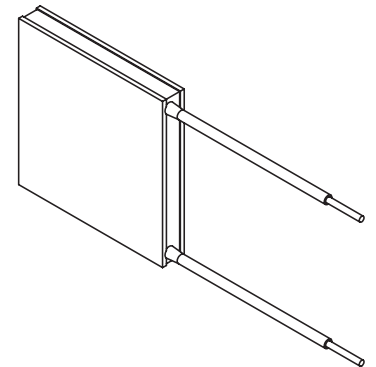
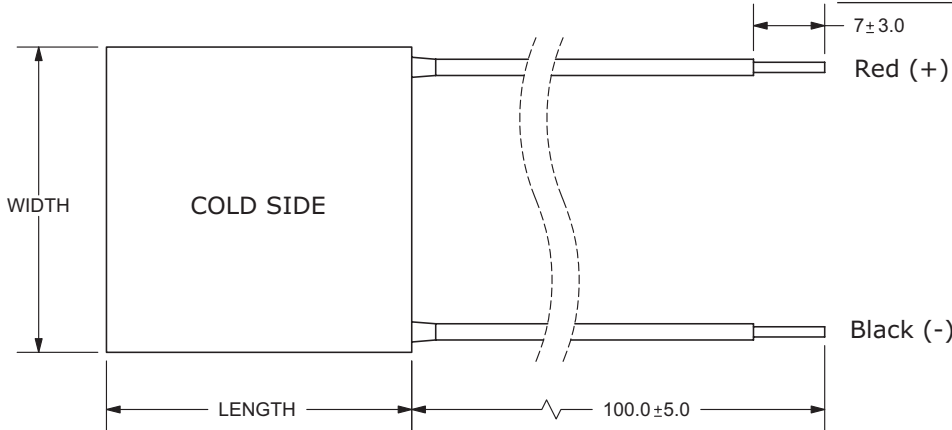

MODEL NO.	LENGTH (mm)	WIDTH (mm)	THICKNESS (mm)
CP40136	15 ±0.3	15 ±0.3	3.6 ±0.1
CP40236	20 ±0.3	20 ±0.3	3.6 ±0.1
CP40336	30 ±0.3	30 ±0.3	3.6 ±0.1
CP40147	15 ±0.3	15 ±0.3	4.7 ±0.1
CP40247	20 ±0.3	20 ±0.3	4.7 ±0.1
CP40301547	30 ±0.3	15 ±0.3	4.7 ±0.1
CP40347	30 ±0.3	30 ±0.3	4.7 ±0.1
CP40447	40 ±0.3	40 ±0.3	4.7 ±0.1

CP40136 PERFORMANCE (Th=27°C)

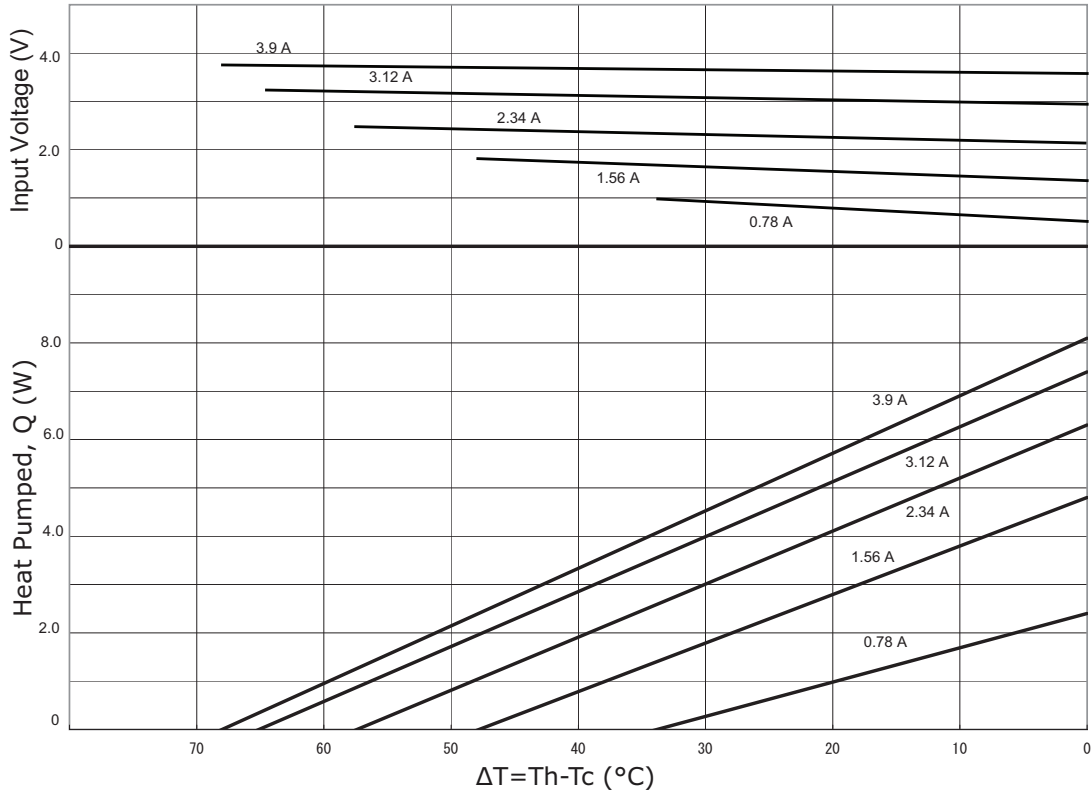

CP40136 PERFORMANCE (Th=50°C)

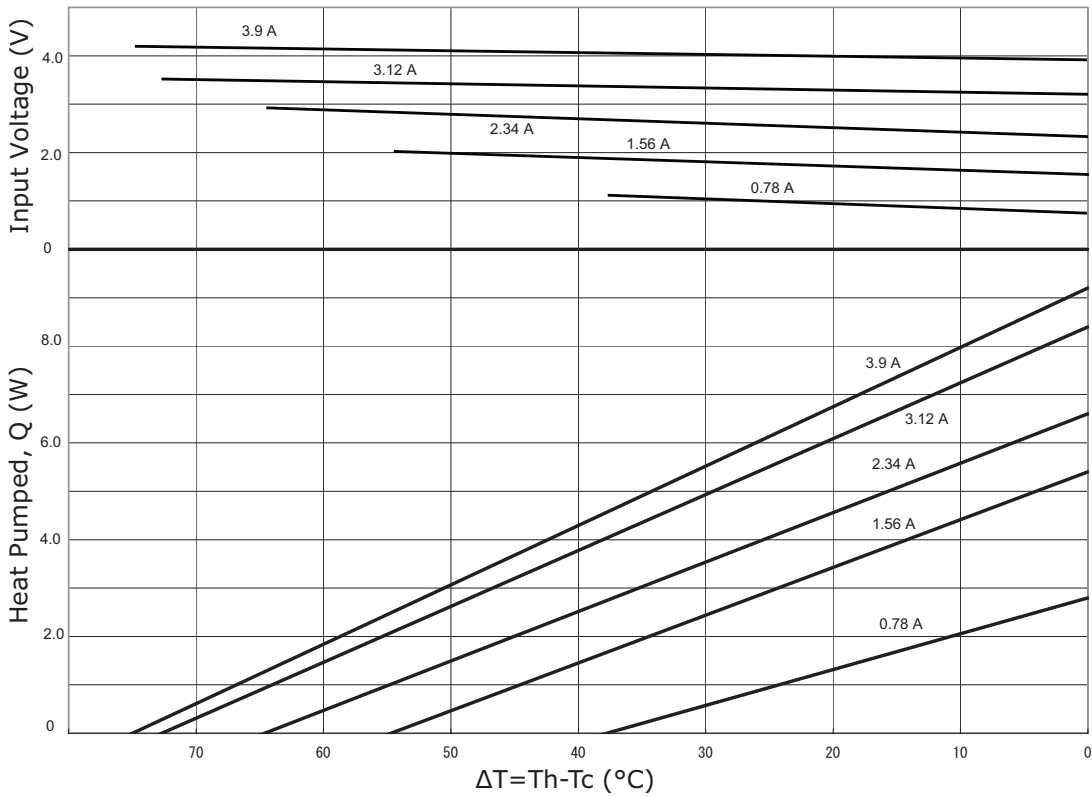

CP40236 PERFORMANCE (Th=27°C)

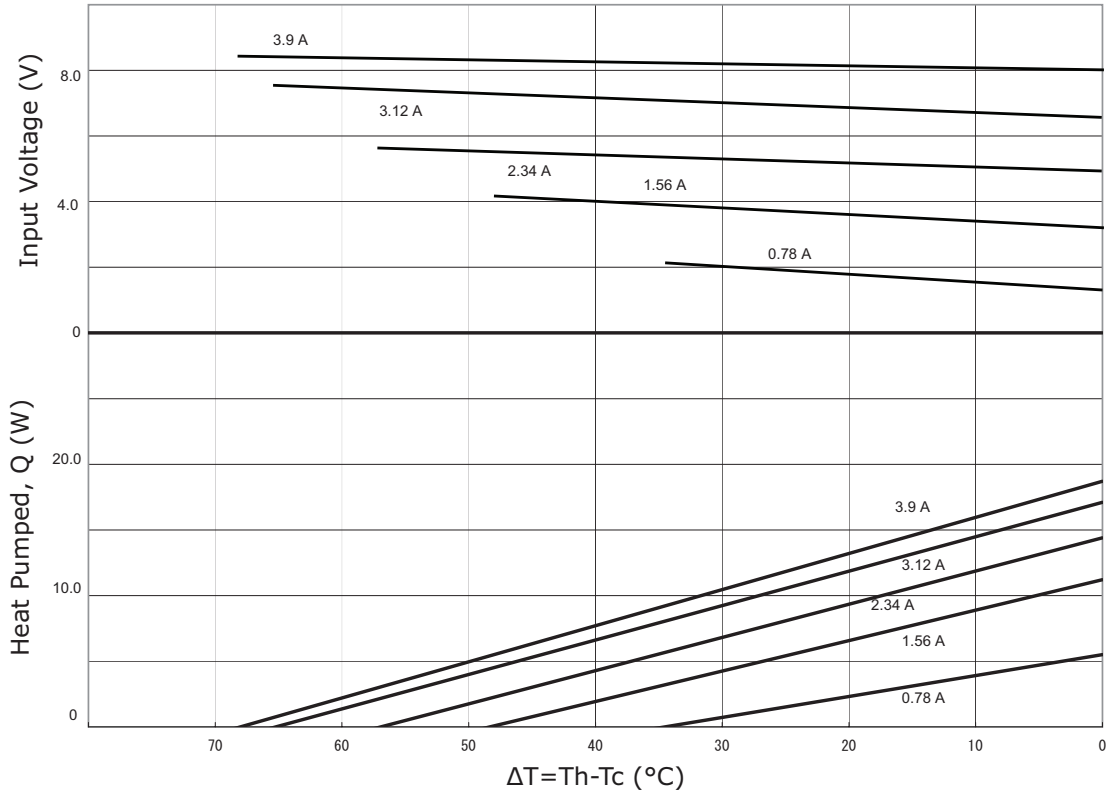

CP40236 PERFORMANCE (Th=50°C)

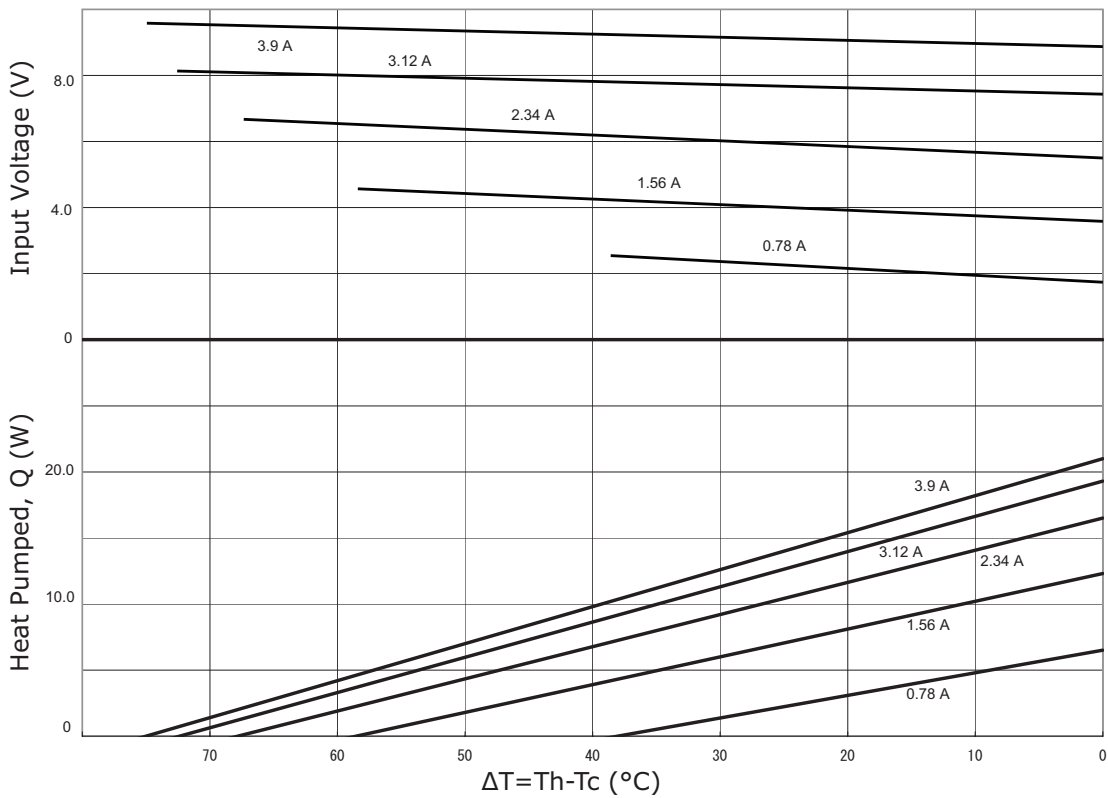

CP40336 PERFORMANCE (Th=27°C)

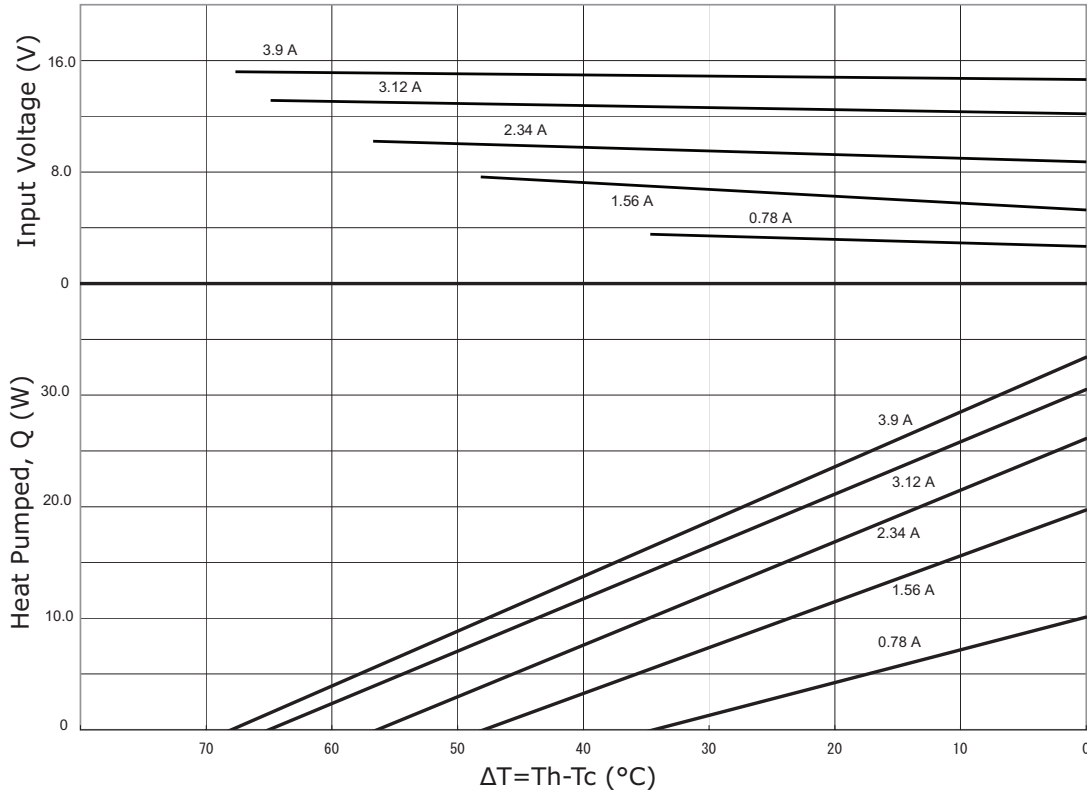

CP40336 PERFORMANCE (Th=50°C)

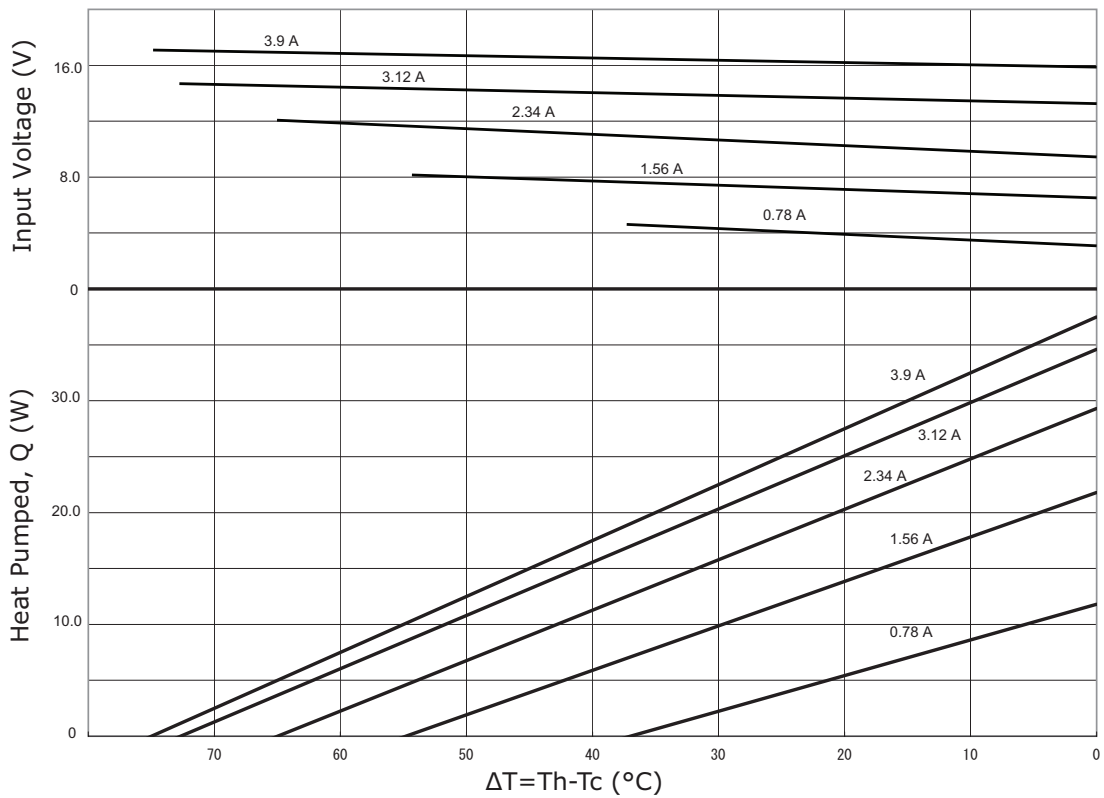

CP40147 PERFORMANCE (Th=27°C)

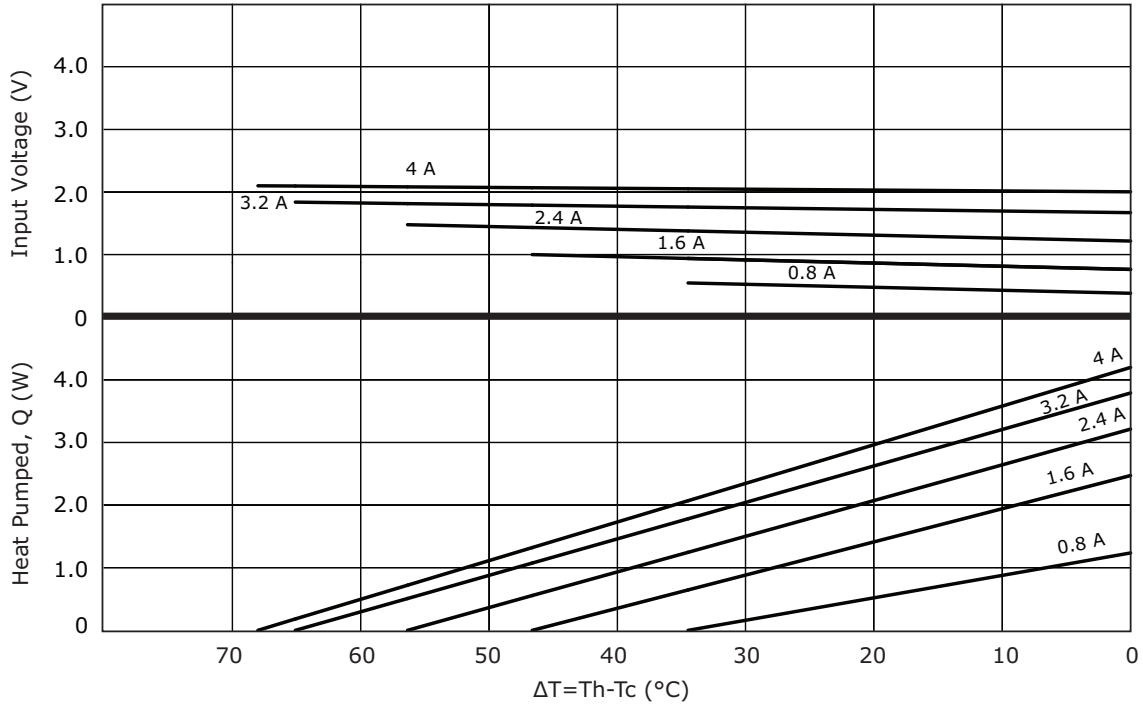

CP40147 PERFORMANCE (Th=50°C)

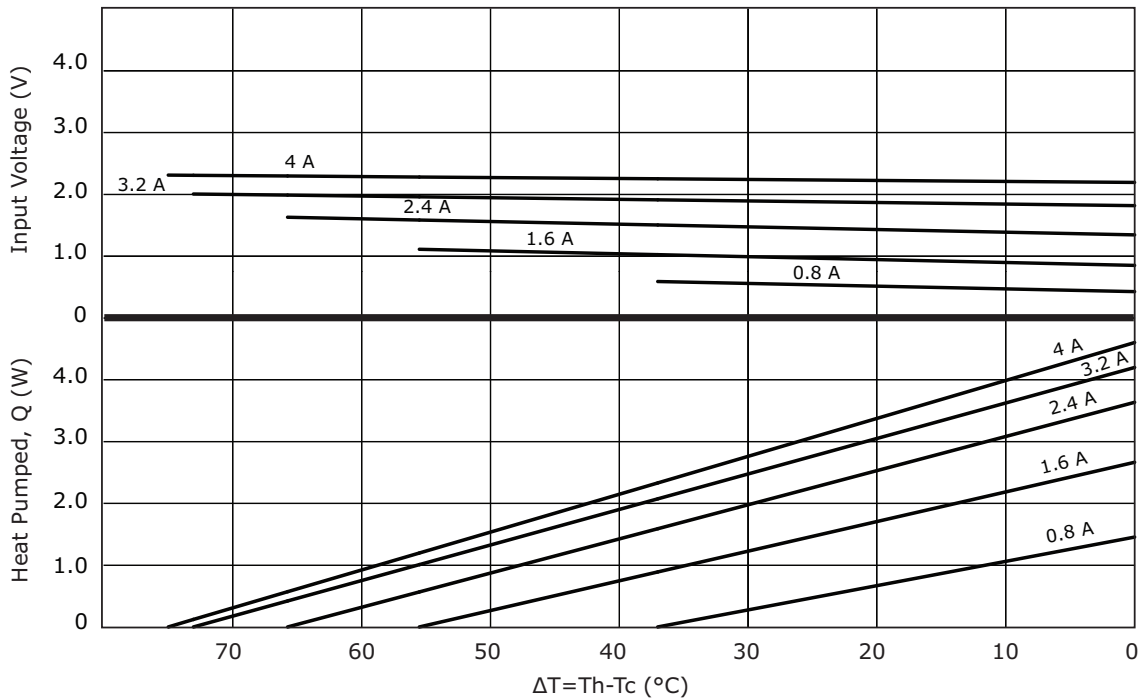

CP40247 PERFORMANCE (Th=27°C)

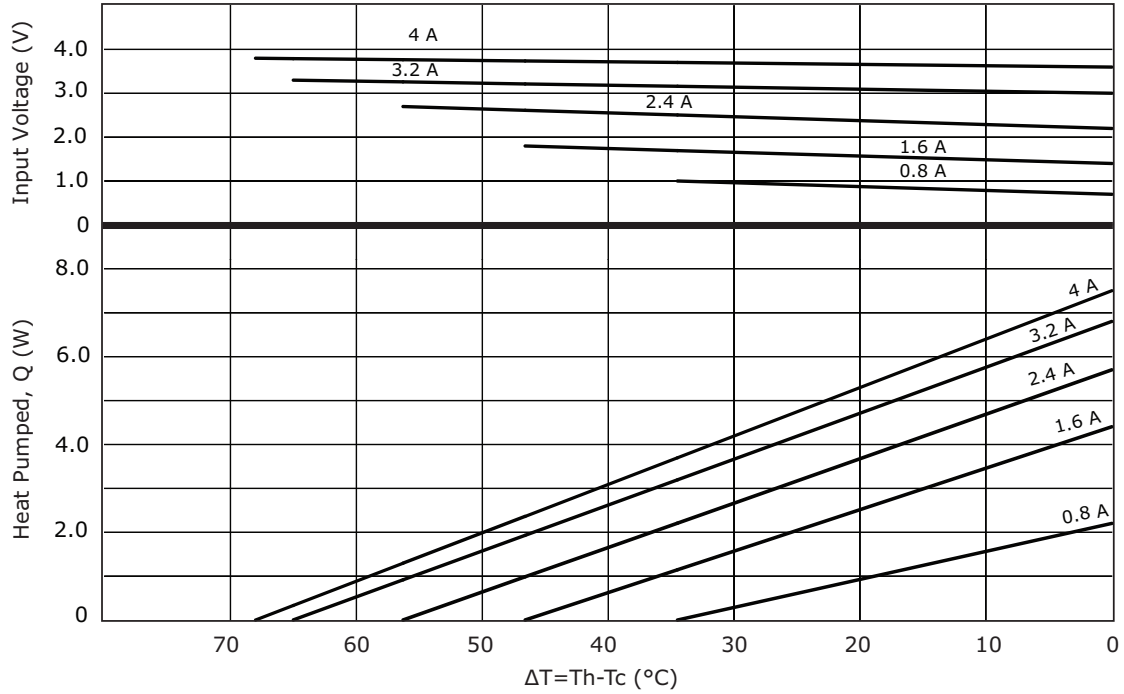

CP40247 PERFORMANCE (Th=50°C)

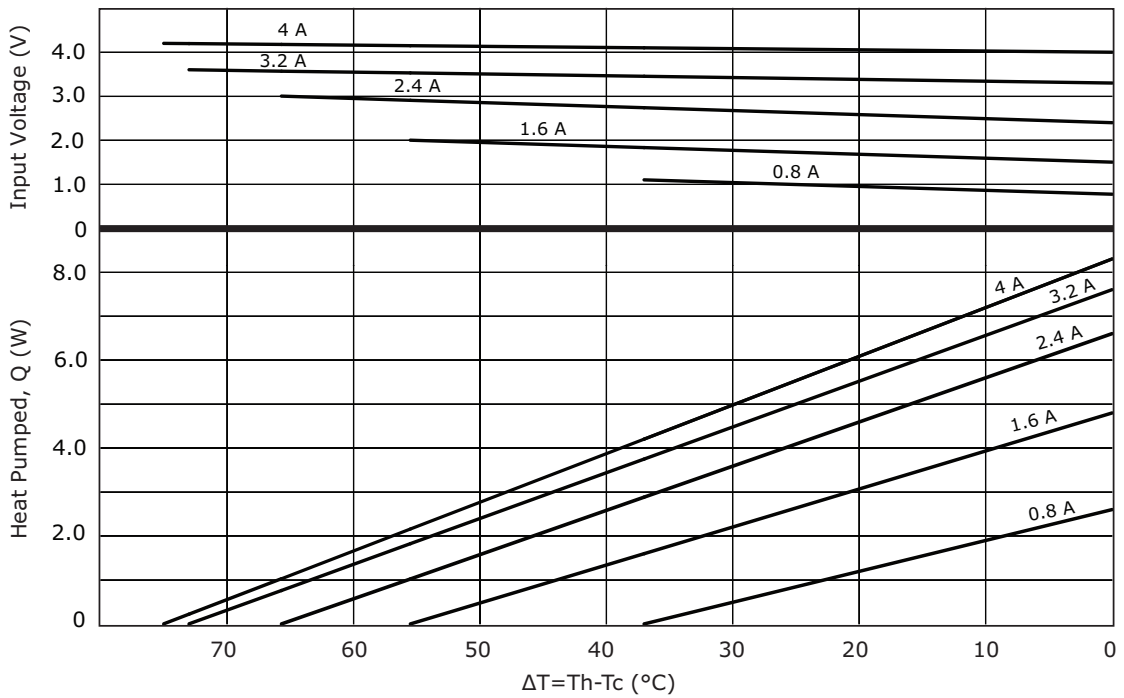

CP40301547 PERFORMANCE (Th=27°C)

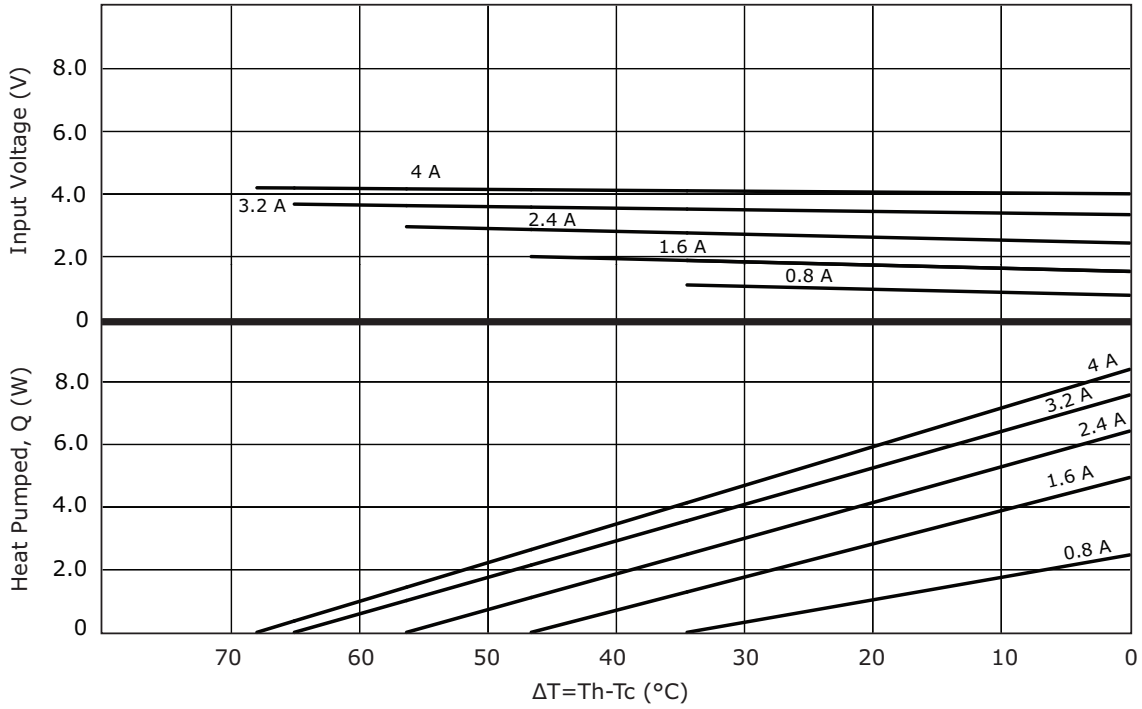

CP40301547 PERFORMANCE (Th=50°C)

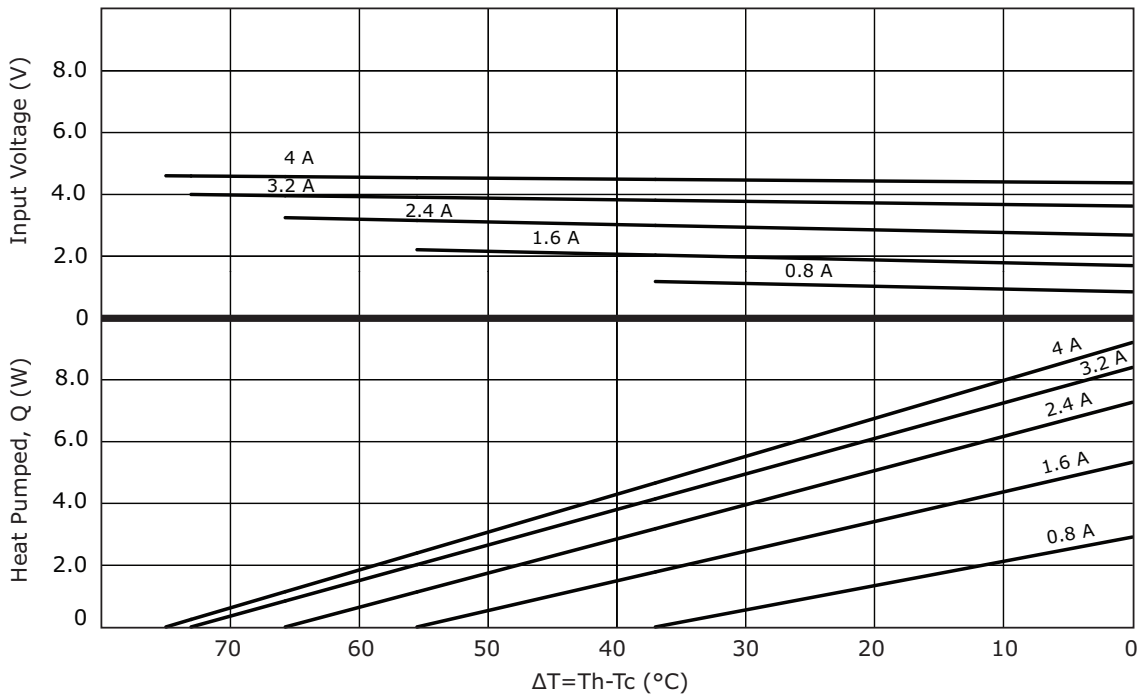

CP40347 PERFORMANCE (Th=27°C)

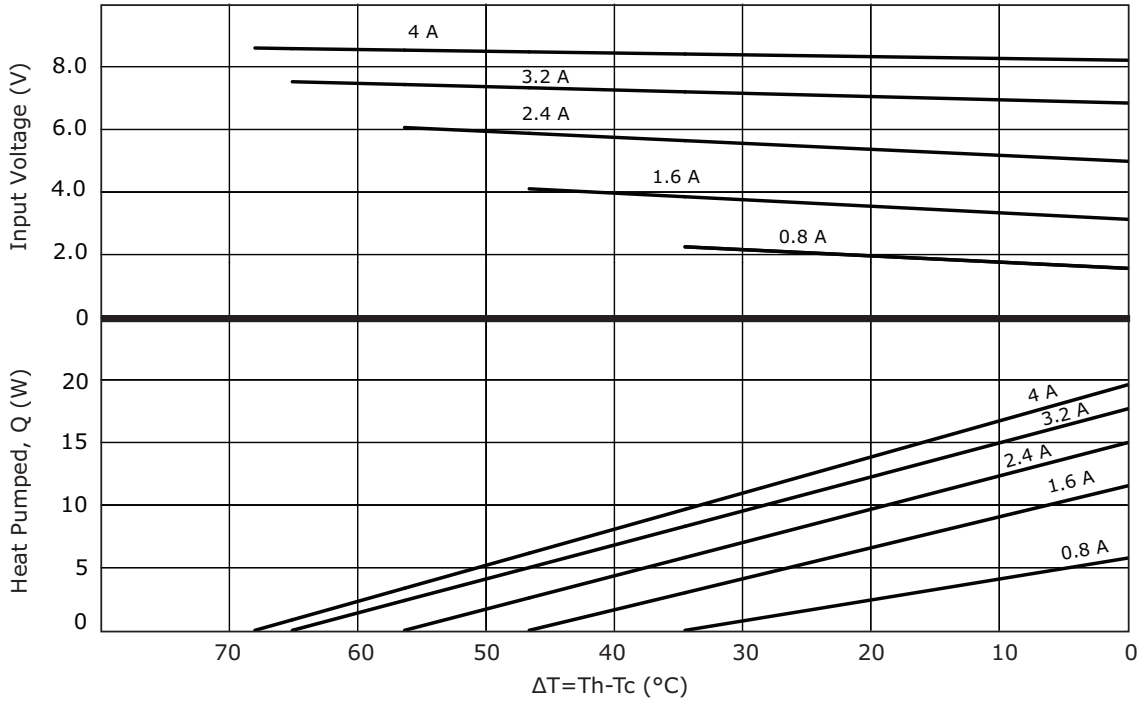

CP40347 PERFORMANCE (Th=50°C)

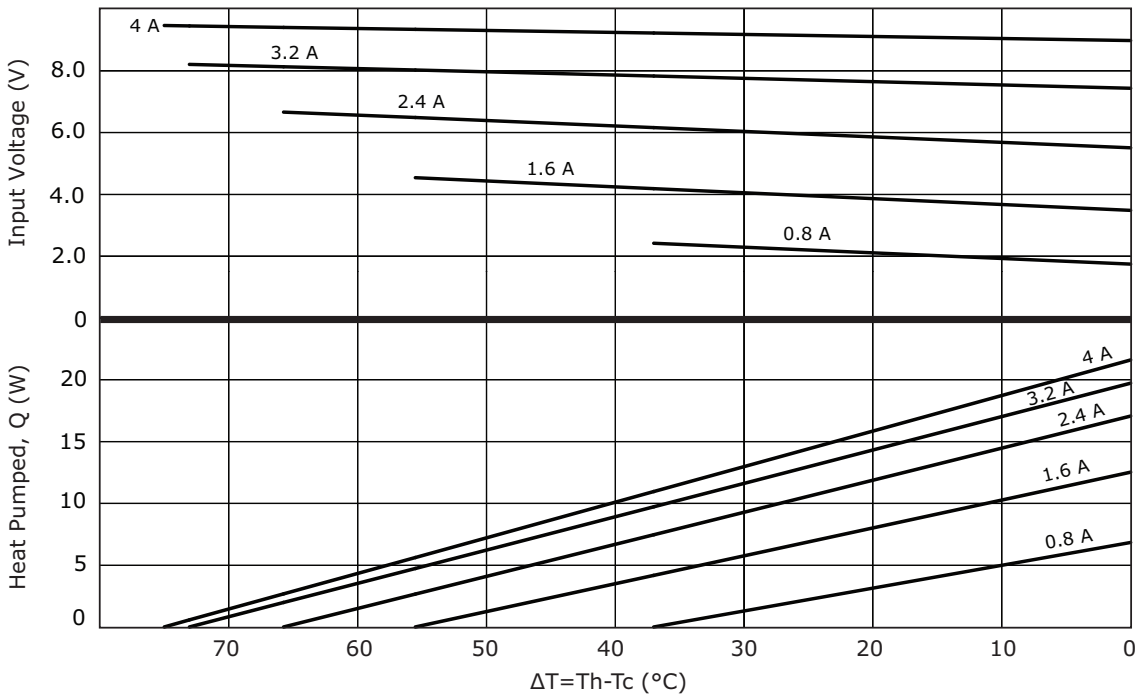

CP40447 PERFORMANCE (Th=27°C)

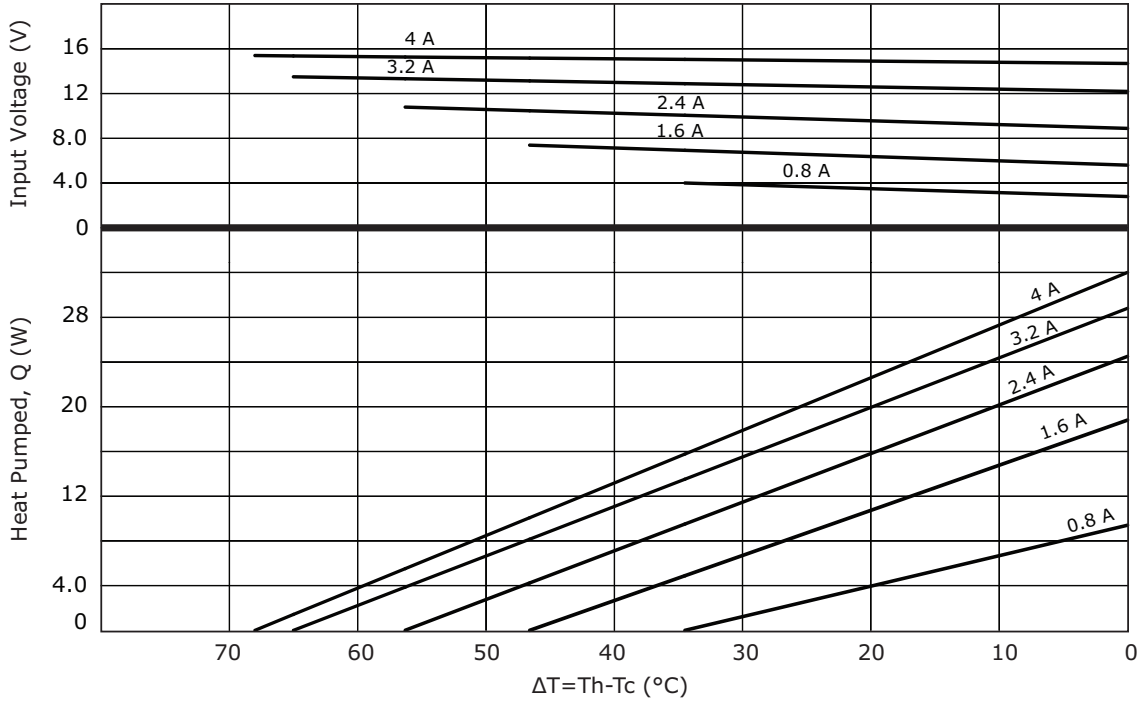

CP40447 PERFORMANCE (Th=50°C)

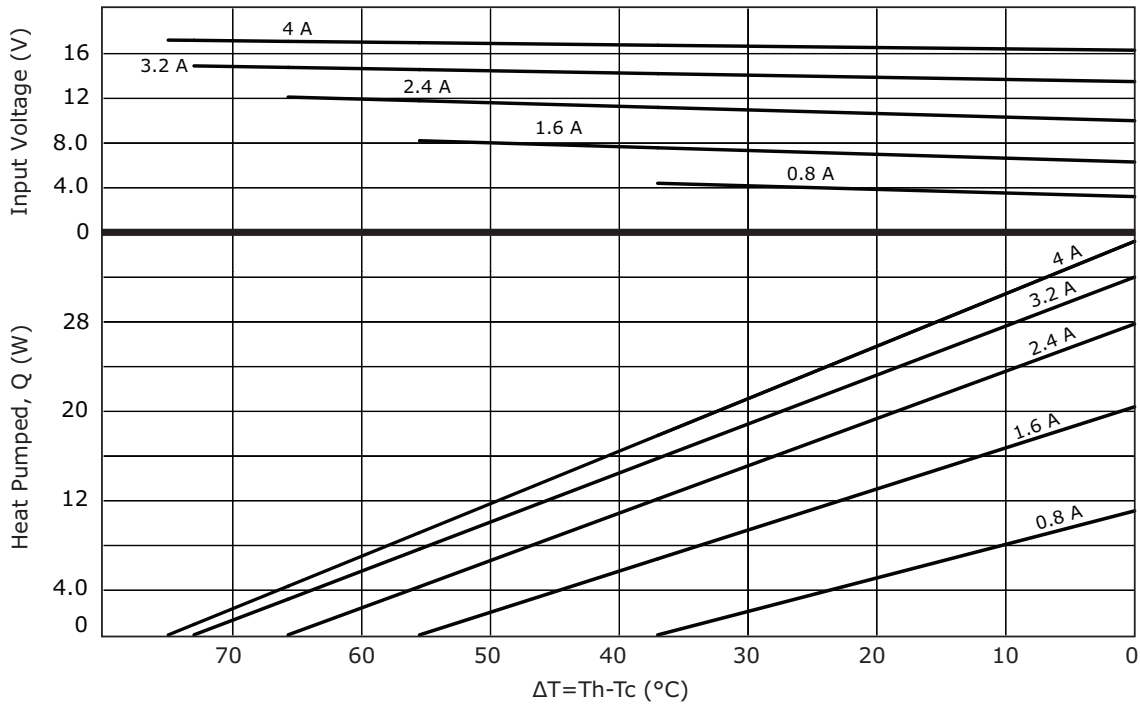

REVISION HISTORY

rev.	description	date
1.0	initial release	09/03/2009
1.01	applied new template	05/08/2012
1.02	added new models	09/08/2016

The revision history provided is for informational purposes only and is believed to be accurate.



Headquarters
20050 SW 112th Ave.
Tualatin, OR 97062
800.275.4899

Fax 503.612.2383
cui.com
techsupport@cui.com

CUI offers a one (1) year limited warranty. Complete warranty information is listed on our website.

CUI reserves the right to make changes to the product at any time without notice. Information provided by CUI is believed to be accurate and reliable. However, no responsibility is assumed by CUI for its use, nor for any infringements of patents or other rights of third parties which may result from its use.

CUI products are not authorized or warranted for use as critical components in equipment that requires an extremely high level of reliability. A critical component is any component of a life support device or system whose failure to perform can be reasonably expected to cause the failure of the life support device or system, or to affect its safety or effectiveness.

Mouser Electronics

Authorized Distributor

Click to View Pricing, Inventory, Delivery & Lifecycle Information:

[CUI Inc.:](#)

[CP40336](#) [CP40347](#) [CP40147](#) [CP40247](#) [CP40301547](#) [CP40447](#)