

NRA Series

Features:

- Available in 4 different styles
- Excellent overload and short circuit protection
- Small size and high-efficiency
- Life expectancy of over 10,000 operations
- UL1077 recognized “Supplementary Protectors”
- VDE certified to EN60934



NRAS



NRAN



NRAR



Rocker



Illuminated Rocker
(with Neon lamp)

Specifications

Protection Method	Electromagnetic tripping
Internal Circuit	Series current trip
Number of Poles	NRAS and NRAN: 1, 2, 3 NRAR: 1
Rated Voltage	250V AC, 50/60Hz, 65V DC
Rated Tripping Currents	0.3A, 0.5A, 0.75A 1A, 2A, 3A, 5A, 7.5A, 10A, 15A, 20A, 25A, 30A
Rated Interrupting Capacity	250V AC, 50/60Hz, 1,000A 65V DC, 1,000A
Auxiliary Contact	SPDT microswitch: 250V AC, 5A (resistive load), 50V DC, 1A (resistive load)
Alarm Contact	SPDT microswitch: 250V AC, 5A (resistive load), 50V DC, 1A (resistive load)
Reference Temperature	25°C
Operating Temperature	-40 to +85°C (avoid freezing)
Insulation Resistance	100MΩ (measured with 500V megger)
Dielectric Strength	Between main circuit terminals: 2,000V AC, 1 minute Between main circuit and auxiliary contact: 2,000V AC, 1 minute
Vibration Resistance	100N (approximately 10G) (10 to 100Hz)
Shock Resistance	1,000N (approximately 100G)
Life Expectancy	Minimum 10,000 cycles (at 6 operations per minute)
Termination	Main terminal: Quick-connect receptacle 0.250" (accepts M3.5 screw terminal adapter) Auxiliary contact, alarm contact: Quick-connect receptacle 0.080"
Illumination Voltage (NRAR illuminated units)	Neon: 120, 240V AC, 50/60Hz



Not suitable for branch circuit protection.

Switches & Pilot Lights

Display Lights

Relays & Sockets

Timers

Terminal Blocks

Circuit Breakers

Part Numbering Guide

NRA series part numbers are composed of up to 8 part number codes. When ordering an NRA series part, select one code from each category.
 Example: NRAR 1 1 11 -F - 30A -AA -1

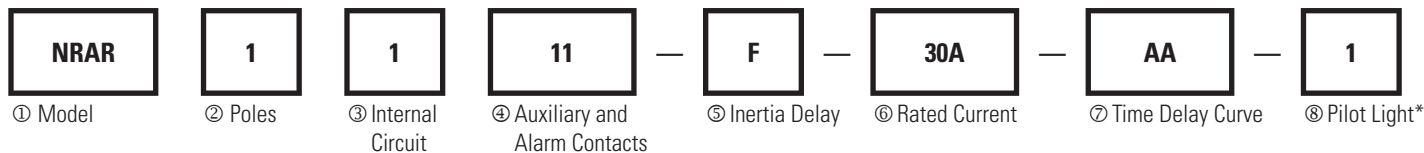

Part Number Codes: NRA Series

	Description	Part Number Code	Remarks
① Model	Lever (round cutout)	NRAS	
	Lever (rectangular cutout)	NRAN	
	Rocker	NRAR	
② No. of Poles	1-pole	1	NRAR available in 1-pole only.
	2-pole	2	All multi-pole circuit breakers are simultaneous throw/simultaneous break.
	3-pole	3	All levers are mechanically interlocked.
③ Internal Circuit	Series current trip	1	
④ Auxiliary and Alarm Contacts	Without	00	
	With auxiliary contact	11	Auxiliary contact switches change state with lever and/or overload condition
	With alarm contact	21	Alarm contact switches change state only with overload condition
⑤ Inertia Delay	Without inertia delay	Blank	
	With inertia delay	F	
⑥ Rated Current	Rated current (current trip)	0.3A, 0.5A, 0.75A, 1A, 2A, 3A, 5A, 7.5A, 10A, 15A, 20A, 25A, 30A	All current ratings must be listed in amps (A). Example conversion: 300mA = 0.30A.
⑦ Time Delay Curve	AC curves	AA, BA,MA	For time delay curves, see page 888.
	DC curves	AD, MD	
⑧ Pilot Light*	With neon light 120V AC (50/60Hz)	1	*Applicable to illuminated NRAR only.
	With neon light 240V AC (50/60Hz)	2	

- 1. For NRA series accessories, see page 886.
- 2. For NRA series time delay curves, see page 888.
- 3. For NRA series dimensions, see page 890.
- 4. Not suitable for branch circuit protection.
- 5. UL recognized, applicable standard: UL1077, "Supplementary Protectors."

Switches & Pilot Lights

Display Lights

Relays & Sockets

Timers

Terminal Blocks

Circuit Breakers

Information About Circuit Breakers

Time Delay Curve Descriptions

Time Delay Curve	NRA Application
AD, AA	Common curves used in molded-case circuit breakers.
BA	Response to overcurrent is quite fast. Suited for protection of semiconductor circuits with very little overload tolerance. If overcurrents are expected to flow, fuses may be required according to the circuit characteristics.
MD, MA	Suited for motor loads that draw high inrush currents lasting a considerable length of time.
With Inertia Delay (F)	Designed not to trip on 20 times the rated current (peak value) for a duration of 8ms. Suited for transformer and lamp loads that draw steep inrush currents.

Inertia Delay Description

Circuit breakers equipped with inertia delay do not respond to high inrush currents such as those produced by transformer, lamp, or motor loads, but perform specified interruption on rated overcurrents.

Specify inertia delay by inserting an "F" in the part number as shown in Part Number Guide on previous page.

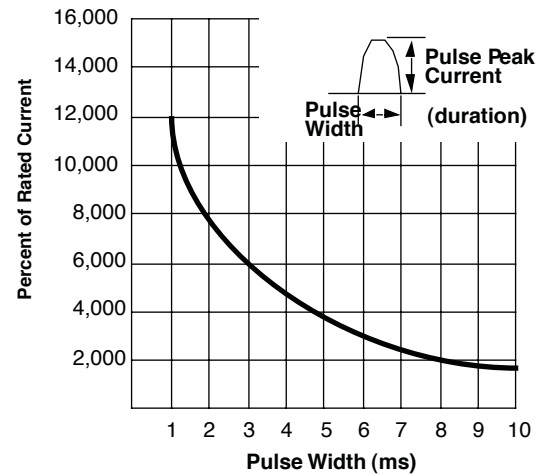

$$1. \text{Percent of Rated Current} = \frac{\text{Pulse Peak Current}}{\text{Protector Rated Current}} \times 100\%$$

2. Based on sinusoidal or parabolic pulse profile.

Notes

Multi-Pole

Multi-pole types such as 2- or 3-pole should be assembled by IDEC.

Because of their characteristics, 1-pole breakers cannot be combined to provide multi-pole units.



Auxiliary and Alarm Contacts

Multi-pole units can incorporate auxiliary and alarm contacts.

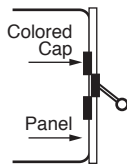

Auxiliary and alarm contacts will not work with IDEC's DIN rail adapters.

Accessories

Part Numbers: NRA Series Accessories

Description	Appearance	Part No.	Remarks
Color Caps (NRAS only)	Red	NR5R	 <p>Colored caps fit onto NRAS circuit breakers for color coding circuits and improving the appearance of the panel.</p>
	Blue	NR5S	
	Yellow	NR5Y	
	White	NR5H	
Screw Terminal Adapter (1 pair)		NRT	For use on main terminals only. Includes M3.5 clamp screw. For dimensions see page 892.

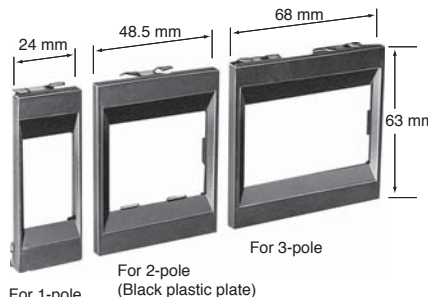
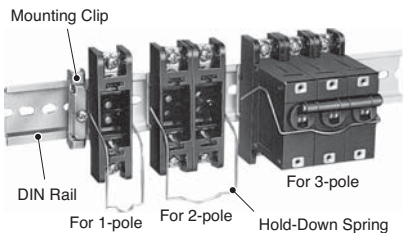
Part Numbers: NRA Mounting Accessories

Description	Appearance	For Model	Number of Poles	Part Number	Remarks
Panel Mount Flush Plate	 <p>For 1-pole For 2-pole (Black plastic plate) For 3-pole</p>	NRAN NRAR	1-pole	NR31	Use of a flush plate makes snap-in mount possible for NRAN, and NRAR circuit breakers (tightening screws not necessary). Multiple units can mount in a single panel cut-out.
		NRAN	2-pole	NR32	
		NRAN	3-pole	NR33	
DIN Rail Plug-in Base		NRAS NRAN	1-pole	NR21	1. Furnished with a hold-down spring. 2. Applicable only for series trip units up to 20 amps. 3. Not applicable for NRAR lighted series. 4. Not for use with circuit breakers incorporating auxiliary or alarm contacts.
		2-pole	NR22		
		3-pole	NR23		
		NRAR	1-pole	NR211	
Surface Mount Plug-in Base		NRAS NRAN	1-pole	NUS1	
			2-pole	NUS2	
			3-pole	NUS3	
		NRAR	1-pole	NUS11	

 For dimensions of NRA series accessories and panel cut-out layouts, see drawings starting on page 891.

Switches & Pilot Lights

Display Lights

Relays & Sockets

Timers

Terminal Blocks

Circuit Breakers

Internal Circuits and Terminal Arrangements: NRAS and NRAN Series

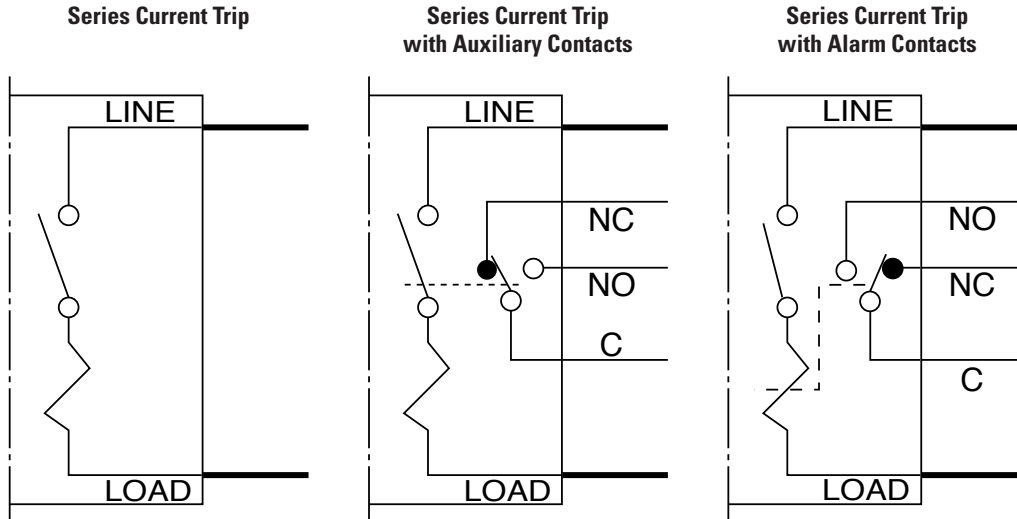

Internal Circuits and Terminal Arrangements: NRAR Series

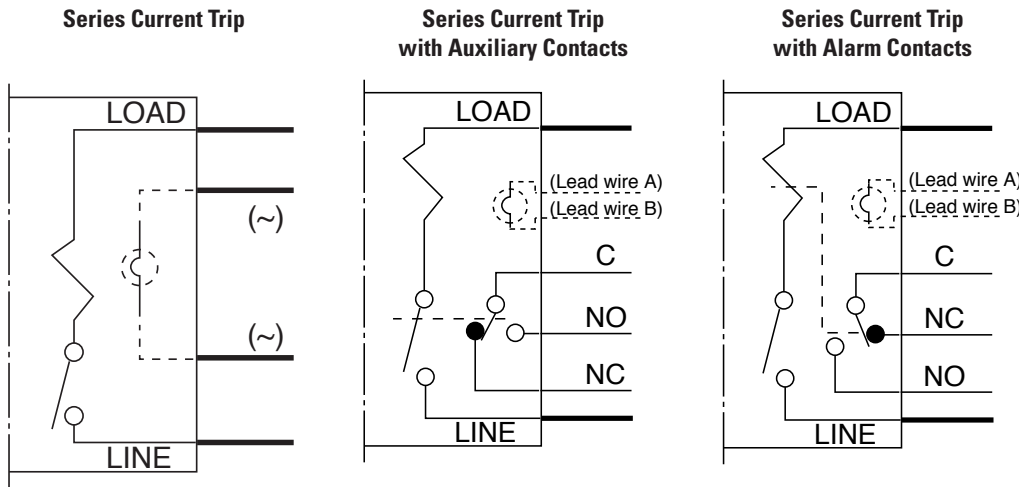

Pilot Lights (NRAR only)

Pilot Light	Lead Wire	
	A	B
Neon (120V AC)	White	White
Neon (240V AC)	Black	Black



Dashed lines represent NRAR illuminated rocker units. Lead wires for neon pilot light as shown above.

Time Delay Curves (numerical equivalent)

Overcurrent — Time Delay Characteristics in Seconds (at 25°C)

	Curve	Percent of Rated Current							
		100%	125%	150%	200%	400%	600%	800%	1000%
AC (50/60Hz)	AA	No trip	10 – 120	6 – 45	2.2 – 15	0.3 – 2	0.05 – 0.55	0.007 – 0.13	0.005 – 0.04
	BA	No trip	0.75 – 10	0.45 – 3.5	0.22 – 1.3	0.045 – 0.22	0.012 – 0.12	0.005 – 0.06	0.004 – 0.03
	MA	No trip	60 – 900	30 – 260	9 – 70	1.5 – 8	0.18 – 2.5	0.009 – 0.25	0.006 – 0.08
DC	AD	No trip	10 – 130	6 – 55	2.6 – 20	0.5 – 3.5	0.12 – 1.4	0.008 – 0.1	0.005 – 0.05
	MD	No trip	35 – 400	20 – 200	7 – 60	1.3 – 8	0.2 – 3	0.01 – 0.25	0.006 – 0.08



1. All values above are in seconds.
2. Data in this table is equivalent to information presented in the time delay curves shown on page 888.

Time Delay Curves – NRA Series

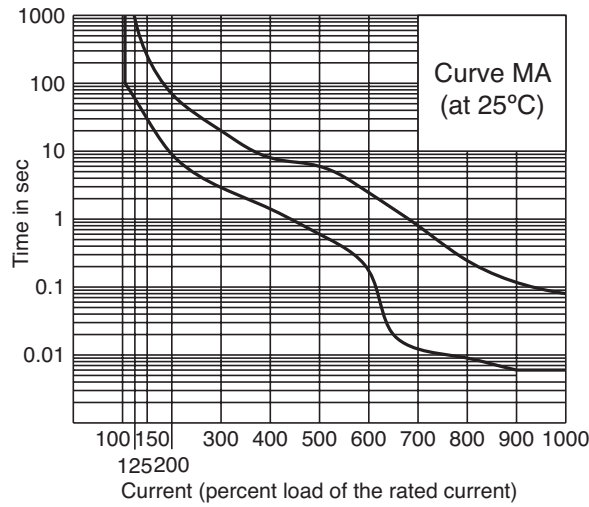
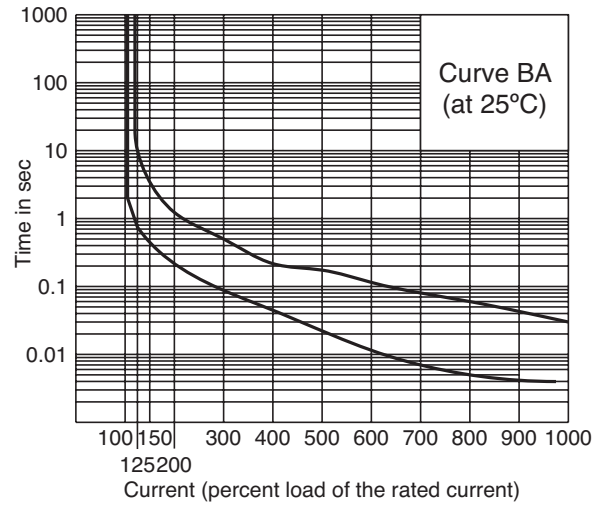
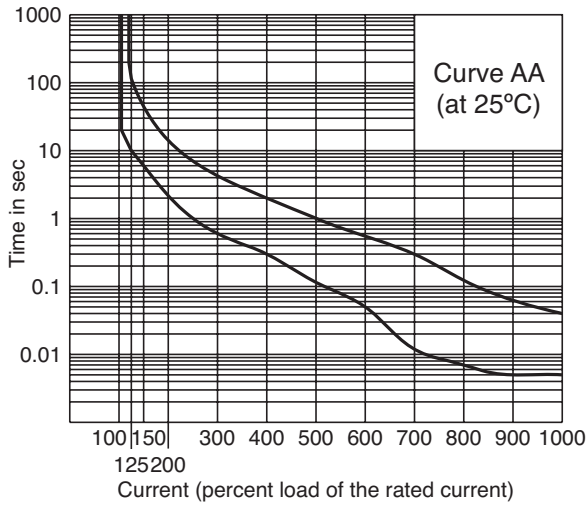

DC Time Delay Curves

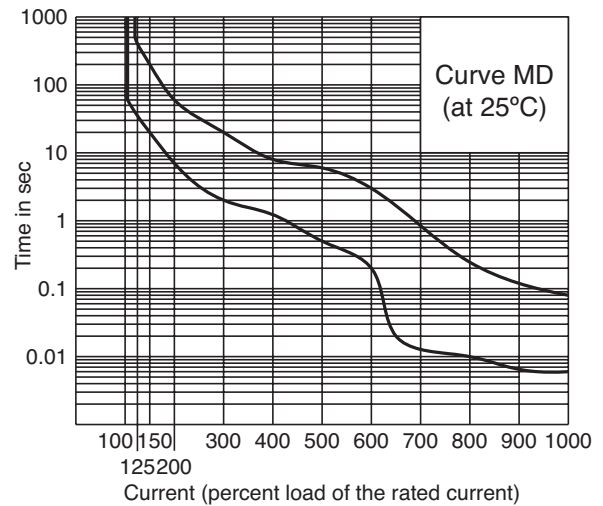
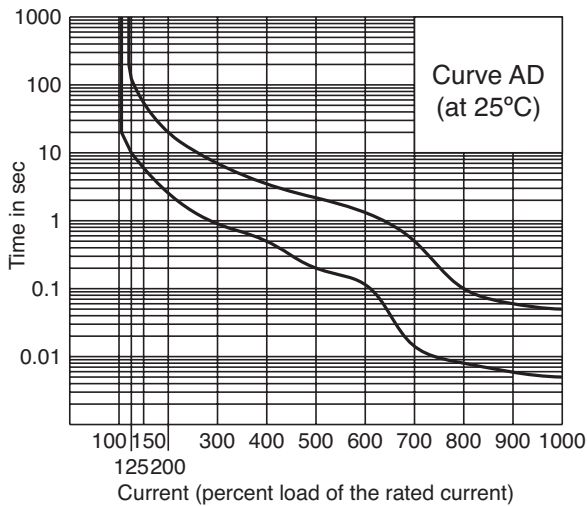

Switches & Pilot Lights

Display Lights

Relays & Sockets

Timers

Terminal Blocks

Circuit Breakers

Resistance and Impedance Characteristics

Coil Data

Rated Current	DC Resistance	AC Impedance (50/60Hz)
	Curves AD, MD	Curves AA, BA, MA
0.3A	9.67Ω	9.82Ω
0.5A	3.24Ω	3.36Ω
0.75A	1.45Ω	1.49Ω
1A	0.90Ω	0.92Ω
2A	0.21Ω	0.21Ω
3A	0.09Ω	0.092Ω
5A	0.036Ω	0.036Ω
7.5A	0.017Ω	0.018Ω
10A	0.012Ω	0.012Ω
15A	0.0066Ω	0.0068Ω
20A	0.0048Ω	0.0048Ω
25A	0.0043Ω	0.0043Ω
30A	0.0036Ω	0.0041Ω



Tolerance ±25% (up to 20A), ±50% (25A and over).

Voltage Drop Due to Resistance or Impedance

The internal resistance or impedance of a circuit breaker tends to be larger for a smaller rated current. Therefore, when circuit breakers with a small rated current are used, voltage drop should be taken into consideration. Internal resistance also varies with time delay curves, even at the same rated current. This should also be considered during installation.

Time Delay Curve and Ambient Temperature

Since NRA series circuit breakers employ an electromagnetic tripping system, the rated current (trip current) is not affected by the ambient temperature, but the time delay varies with the oil viscosity in the tube. Lower oil viscosity at higher temperatures results in shorter delay; whereas at lower temperatures, the delay will be prolonged. The time delay curves, shown starting on page 888, are at 25°C. Time delay curves can be corrected.

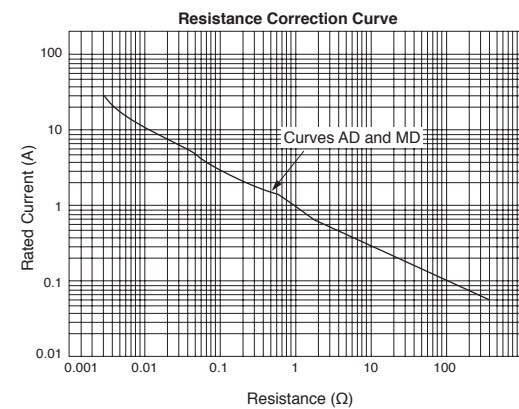
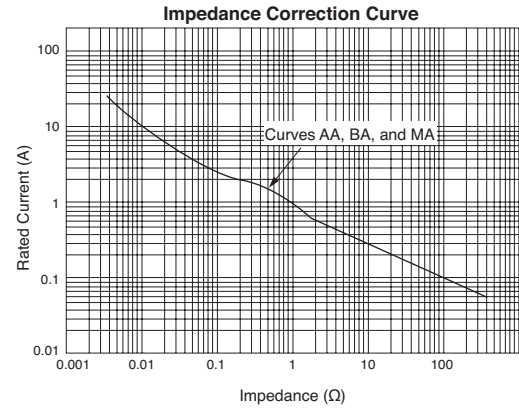

Temperature Correction Curves

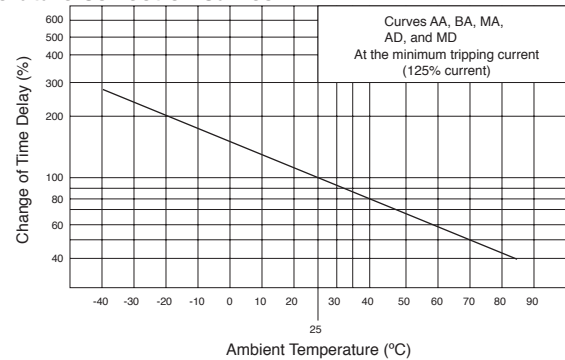

Dimensions

NRAS

•1-pole

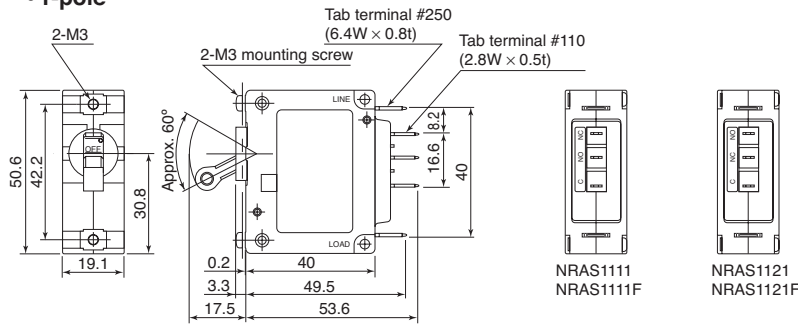

•2-pole

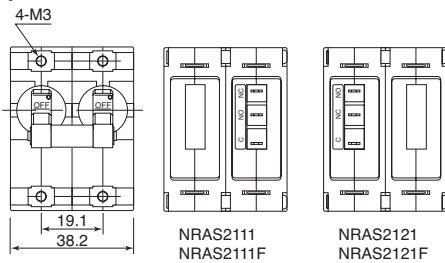

•3-pole

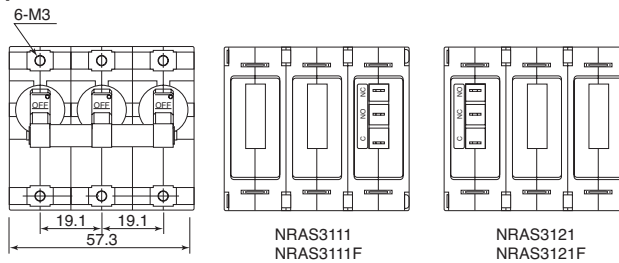

NRAN

•1-pole

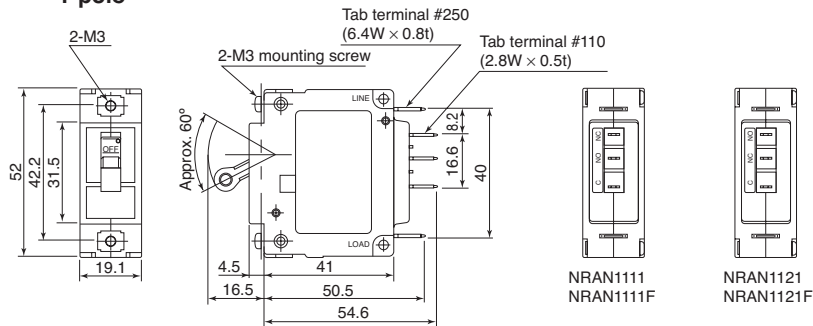

•2-pole

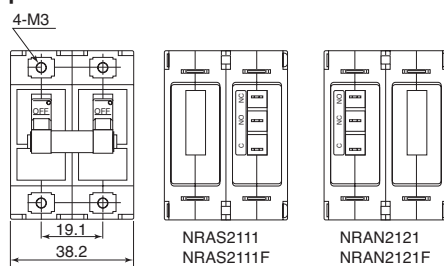

•3-pole

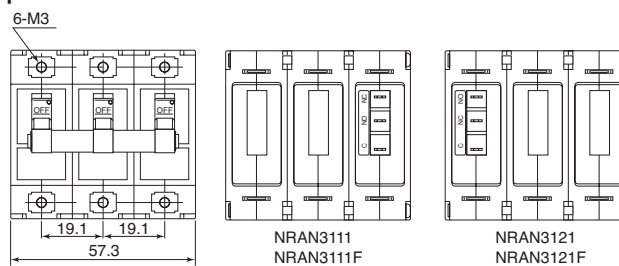

NRAR

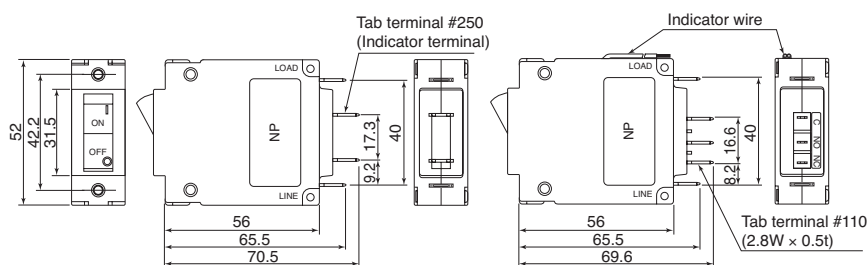

Switches & Pilot Lights

Display Lights

Relays & Sockets

Timers

Terminal Blocks

Circuit Breakers

Panel Cut-Outs

NRAS Series

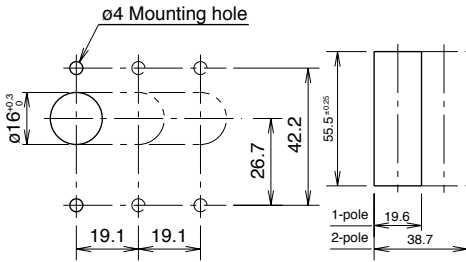

NRAR, NRAN

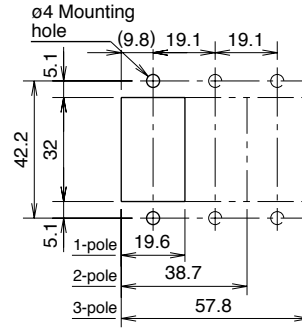

NR31, NR32, NR33 – Panel Mount Flush Plate

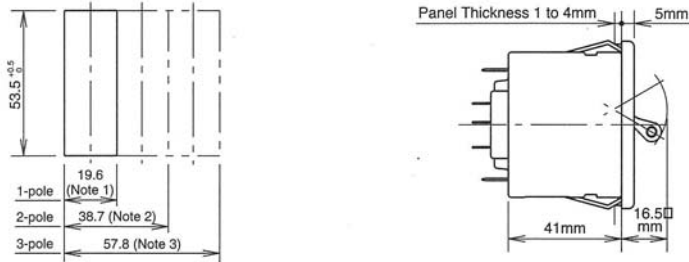

Panel cut-out when two or more units are mounted closely (n = number of units).
 Note 1: 24.3n - 5
 Note 2: 48.8n - 10
 Note 3: 69.3n - 10



Installation Angle: Circuit breakers are designed to operate on a vertical surface. The mounting angle should not exceed a vertical plane by more than 10°.

Model	Maximum Mounting Distance		Dimensions (mm)	
	A	B	Mounting to Panel Surface	Mounting to DIN Rail
NRAS	3.02" (77.5mm)	3.57" (91.5mm)	Mounting on a panel surface 19.1 mm, 20.2 mm	Mounting on a DIN rail 26 mm, 75 mm
NRAN	3.02" (77.5mm)	3.57" (91.5mm)	Mounting on a panel surface 19.1 mm, 20.2 mm	Mounting on a DIN rail 26 mm, 75 mm
NRAR	3.38" (86.7mm)	3.93" (100.7mm)	Mounting on a panel surface 19.1 mm, 20.2 mm	Mounting on a DIN rail 26 mm, 75 mm

Accessory Dimensions

NRT: Screw Terminal Adapter (for use with NRA Series)

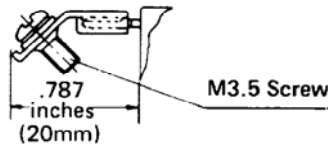

- 1. For use on main terminals only.
- 2. Includes M3.5 clamp screw.

BNDN1000 Aluminum DIN Rail

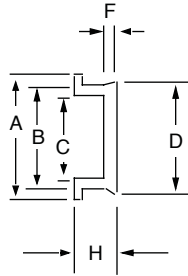
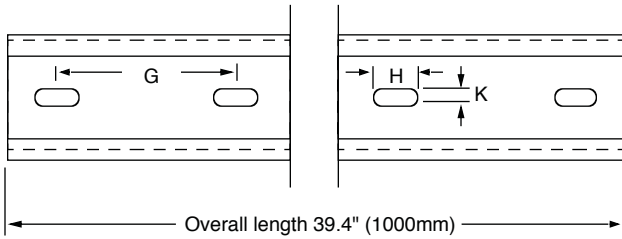

	Length in Inches (mm)
A	1.4" (35mm)
B	1.14" (29mm)
C	0.78" (23mm)
D	1.2" (31mm)
E	0.41" (10.5mm)
F	0.11" (3mm)
G	2" (51mm)
H	0.47" (12mm)
K	0.16" (4mm)

Switches & Pilot Lights

Display Lights

Relays & Sockets

Timers

Terminal Blocks

Circuit Breakers

Mouser Electronics

Authorized Distributor

Click to View Pricing, Inventory, Delivery & Lifecycle Information:

IDEC:

[NRAR1100-15A-AA](#) [NRAR1100-F-3A-BA-1](#) [NRAR1100-F-15A-BA-1](#) [NRAR1100-F-7.5A-BA-1](#) [NRAR1100-5A-MA-1](#)
[NRAN3100-1A-AA](#) [NRAS1111-0.75A-AA](#) [NRAN1100-3A-BA](#) [NRAR1111-0.5A-AA-2](#) [NRAS1100-F-25A-BA](#)
[NRAS3111-15A-BA](#) [NRAN1121-5A-AA](#) [NRAS2100-2A-AA](#) [NRAS2111-20A-AD](#) [NRAS1100-0.5A-BA](#) [NRAN1100-F-1A-MD](#) [NRAS1111-2A-BA](#) [NRAN2111-20A-AA](#) [NRAS2100-20A-MA](#) [NRAR1100-7.5A-AA-1](#) [NRAS2111-F-20A-AA](#)
[NRAS1100-1A-MA](#) [NRAN2100-2A-AA](#) [NRAR1111-20A-AA-2](#) [NRAN1121-F-0.5A-MA](#) [NRAS1100-F-2A-MA](#)
[NRAS3100-F-10A-MA](#) [NRAN3111-F-10A-AA](#) [NRAS1100-3A-MD](#) [NRAR1111-15A-AA-1](#) [NRAS2111-5A-MA](#)
[NRAN1100-25A-AA](#) [NRAS2100-2A-AD](#) [NRAN1100-10A-AA](#) [NRAS1111-3A-BA](#) [NRAS1100-20A-BA](#) [NRAS2111-2A-MA](#) [NRAS1111-10A-AA](#) [NRAN1100-F-2A-AA](#) [NRAR1111-1A-AA-1](#) [NRAS1100-F-5A-AA](#) [NRAS2100-F-7.5A-MA](#)
[NRAN2100-0.5A-AA](#) [NRAN1100-F-2A-BA](#) [NRAS1100-F-0.5A-BA](#) [NRAS1111-F-20A-AD](#) [NRAS2121-5A-BA](#)
[NRAN1100-1A-AD](#) [NRAS1111-20A-AA](#) [NRAN3100-F-10A-AA](#) [NRAS2100-1A-MA](#) [NRAS1121-1A-BA](#) [NRAS1100-15A-MD](#) [NRAN2100-5A-AD](#) [NRAN2100-0.75A-AA](#) [NRAS1100-15A-AD](#) [NRAN2100-10A-MA](#) [NRAN1100-25A-MD](#)
[NRAN3100-0.5A-AA](#) [NRAN1100-F-5A-AD](#) [NRAR1111-F-7.5A-AA-1](#) [NRAN2100-F-2A-AA](#) [NRAS1100-F-5A-BA](#)
[NRAN2100-0.5A-AD](#) [NRAS2121-20A-AA](#) [NRAS1100-2A-BA](#) [NRAS2100-3A-MD](#) [NRAR1121-1A-BA-1](#) [NRAR1100-F-5A-MA-2](#) [NRAN1100-F-1A-MA](#) [NRAR1121-2A-BA-1](#) [NRAN1100-10A-MA](#) [NRAN2100-3A-MA](#) [NRAN2100-F-10A-AD](#)
[NRAS3100-10A-AA](#) [NRAS2121-2A-AA](#) [NRAS1100-2A-MA](#) [NRAS1100-F-20A-AD](#) [NRAR1100-F-7.5A-AA-1](#)
[NRAS1121-30A-AA](#) [NRAS2100-F-30A-MA](#) [NRAS1100-F-5A-AD](#) [NRAS1121-F-1A-AA](#) [NRAN1100-5A-AA](#)
[NRAS1111-F-15A-AA](#) [NRAN2100-7.5A-AA](#) [NRAS2100-F-20A-AA](#) [NRAN2100-5A-BA](#) [NRAS2100-7.5A-AA](#)
[NRAN3100-2A-MA](#) [NRAS2111-30A-AA](#) [NRAS2100-F-20A-MA](#) [NRAS3121-30A-BA](#) [NRAS2121-5A-AA](#) [NRAN2100-10A-AA](#) [NRAS1121-20A-AA](#) [NRAN1100-3A-MA](#) [NRAN2100-15A-AA](#) [NRAN1100-F-7.5A-AD](#) [NRAS3100-30A-MA](#)