

### Description

Single and multipole magnetic circuit breakers with trip-free mechanism and toggle actuation. A choice of fast magnetic only or hydraulically delayed switching characteristics (S-type MO or HM CBE to EN 60934) ensures suitability for a wide range of applications. Industry standard dimensions and panel mounting. Options include auxiliary changeover contacts. Low temperature sensitivity at rated load.

Approved to CBE standard EN 60934 (IEC 60934).

### Typical application

Control equipment, communications systems, transportation, power supplies.

### Standard current ratings and typical internal resistance values

| Current rating (A) | Internal resistance values (Ω) per pole |        |            |            |
|--------------------|-----------------------------------------|--------|------------|------------|
|                    | F1                                      | F2     | K1, M1, T1 | K2, M2, T2 |
| 0,02               | 1 493                                   | 953    | 2 669      | 2 457      |
| 0,05               | 276                                     | 152    | 452        | 376        |
| 0,1                | 58                                      | 37     | 100        | 94         |
| 0,25               | 8,2                                     | 6,0    | 15,5       | 14,7       |
| 0,5                | 2,3                                     | 1,47   | 3,9        | 3,2        |
| 0,75               | 0,98                                    | 0,63   | 1,65       | 1,56       |
| 1                  | 0,58                                    | 0,35   | 0,95       | 0,90       |
| 2                  | 0,145                                   | 0,096  | 0,26       | 0,20       |
| 2,5                | 0,096                                   | 0,061  | 0,15       | 0,15       |
| 3                  | 0,065                                   | 0,048  | 0,10       | 0,10       |
| 5                  | 0,025                                   | < 0,02 | 0,042      | 0,040      |
| 6                  | < 0,02                                  | < 0,02 | 0,029      | 0,028      |
| 8                  | < 0,02                                  | < 0,02 | < 0,02     | < 0,02     |
| 10                 | < 0,02                                  | < 0,02 | < 0,02     | < 0,02     |
| 12                 | < 0,02                                  | < 0,02 | < 0,02     | < 0,02     |
| 15                 | < 0,02                                  | < 0,02 | < 0,02     | < 0,02     |
| 16                 | < 0,02                                  | < 0,02 | < 0,02     | < 0,02     |
| 20                 | < 0,02                                  | < 0,02 | < 0,02     | < 0,02     |
| 25                 | < 0,02                                  | < 0,02 | < 0,02     | < 0,02     |
| 30                 | < 0,02                                  | < 0,02 | < 0,02     | < 0,02     |
| 40                 | < 0,01                                  | -      | < 0,01     | -          |
| 50                 | < 0,01                                  | -      | < 0,01     | -          |

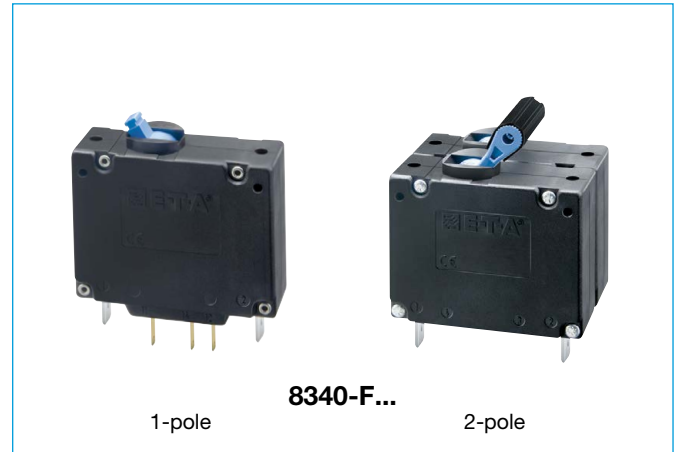

### Technical data

**For further details please see chapter: Technical Information**

|                                                     |                                                                                                                                                                                                                                                                                                                                                              |                                                                                                                                     |                                                      |
|-----------------------------------------------------|--------------------------------------------------------------------------------------------------------------------------------------------------------------------------------------------------------------------------------------------------------------------------------------------------------------------------------------------------------------|-------------------------------------------------------------------------------------------------------------------------------------|------------------------------------------------------|
| Voltage rating                                      | 3 AC 415 V; AC 240 V, 50/60 Hz; DC 80 V (higher DC ratings to special order)                                                                                                                                                                                                                                                                                 |                                                                                                                                     |                                                      |
| Current ratings                                     | 0.02...50 A DC<br>0.02...30 A AC                                                                                                                                                                                                                                                                                                                             |                                                                                                                                     |                                                      |
| Auxiliary circuit                                   | 6 A, AC 240 V;<br>3 A, DC 28 V;<br>1 A, DC 65 V;<br>0.5 A, DC 80 V                                                                                                                                                                                                                                                                                           |                                                                                                                                     |                                                      |
| Typical life                                        | 3 AC 415 V, AC 240 V:<br>0.02...30 A 6,000 operations at 1 x I <sub>N</sub> , inductive<br>10,000 operations at 1 x I <sub>N</sub> , resistive<br>DC 80 V: 0.02...25 A 6,000 operations at 1 x I <sub>N</sub> , inductive<br>0.02...30 A 10,000 operations at 1 x I <sub>N</sub> , resistive<br>40 + 50 A 6,000 operations at 1 x I <sub>N</sub> , resistive |                                                                                                                                     |                                                      |
| Ambient temperature                                 | -40...+85 °C (-40...+185 °F)                                                                                                                                                                                                                                                                                                                                 |                                                                                                                                     |                                                      |
| Insulation co-ordination (IEC 60664 and 60664A)     | rated impulse withstand voltage<br>2.5 kV<br>reinforced insulation in operating area                                                                                                                                                                                                                                                                         | pollution degree<br>2                                                                                                               |                                                      |
| Dielectric strength (IEC 60664 and 60664A)          | operating area<br>Line to Load<br>pole to pole (2- and 3-pole)<br>main to auxiliary circuit<br>switching to trip circuit (version -X)                                                                                                                                                                                                                        | test voltage AC 3,000 V<br>test voltage AC 1,500 V<br>test voltage AC 1,500 V<br>test voltage AC 3,000 V<br>test voltage AC 1,500 V |                                                      |
| Insulation resistance                               | > 100 MΩ (DC 500 V)                                                                                                                                                                                                                                                                                                                                          |                                                                                                                                     |                                                      |
| Interrupting capacity (IEC 60934 - test sequence E) | 4 x IN at AC;<br>4 x IN at DC                                                                                                                                                                                                                                                                                                                                |                                                                                                                                     |                                                      |
| Interrupting capacity (UL 1077)                     | I <sub>N</sub>                                                                                                                                                                                                                                                                                                                                               | 0.02...20 A                                                                                                                         | 25...30 A                                            |
|                                                     | AC:                                                                                                                                                                                                                                                                                                                                                          | 1-pole AC 250 V/3,500A<br>2-pole AC 250 V/3,500A<br>3-pole 3AC 250V/3,500A                                                          | AC 250 V/3,500A<br>AC 250 V/5,000A<br>3AC250V/5,000A |
|                                                     | DC:                                                                                                                                                                                                                                                                                                                                                          | 1-pole 0.02...50 A<br>2-pole 0.02...30 A                                                                                            | DC 80 V/3,500 A<br>DC 80 V/3500 A                    |
| Degree of protection (IEC 60529/DIN 40050)          | operating area IP40<br>terminal area IP00                                                                                                                                                                                                                                                                                                                    |                                                                                                                                     |                                                      |
| Vibration                                           | with toggle down: 10 g (57-2000Hz) ± 0.76 mm (10-57 Hz) at 0.9 x IN<br>directions 1, 2, 3, 4, 5: 10 g (57-2000 Hz) at 1 x IN.                                                                                                                                                                                                                                |                                                                                                                                     |                                                      |
| Shock                                               | 100 g (11 ms) at 1 x IN, directions 1,2,3,4,5<br>100 g (11 ms) at 0.8 x IN, direction 6.                                                                                                                                                                                                                                                                     |                                                                                                                                     |                                                      |
| Corrosion                                           | 96 hours at 5 % salt mist, to IEC 60068-2-11, test Ka                                                                                                                                                                                                                                                                                                        |                                                                                                                                     |                                                      |
| Humidity                                            | 240 hours at 95 % RH to IEC 60068-2-78, test Cab                                                                                                                                                                                                                                                                                                             |                                                                                                                                     |                                                      |
| Mass                                                | approx. 65 g per pole                                                                                                                                                                                                                                                                                                                                        |                                                                                                                                     |                                                      |

**Ordering information**

|                                                            |                                                                                                                                                                                                                              |
|------------------------------------------------------------|------------------------------------------------------------------------------------------------------------------------------------------------------------------------------------------------------------------------------|
| <b>Type No.</b>                                            | 8340 magnetic circuit breaker with toggle actuator                                                                                                                                                                           |
| <b>Mounting</b>                                            | F flange mounting                                                                                                                                                                                                            |
| <b>Configuration</b>                                       | 1 with mounting nuts 6-32 UNC<br>4 with mounting nuts M3<br>9 snap-in frame                                                                                                                                                  |
| <b>Number of poles</b>                                     | 1 single pole protected<br>2 two pole protected<br>3 three pole protected                                                                                                                                                    |
|                                                            | } magnetic and hydraulic magnetic delayed                                                                                                                                                                                    |
| <b>Panel hardware</b>                                      | 0 without panel hardware                                                                                                                                                                                                     |
| <b>Terminal design (main contact)</b>                      | K4 screw terminals M5 recommended for $I_N > 20$ A<br>P1 blade terminals A6.3-0.8 mm (QC.250) ( $\leq 35$ A)                                                                                                                 |
| <b>Characteristic curve *)</b>                             | <b>Characteristic curve, instantaneous:</b><br>F1 DC<br>F2 AC 50/60 Hz<br><b>Short delay:</b><br>K1 DC<br>K2 AC 50/60 Hz<br><b>Medium delay:</b><br>M1 DC<br>M2 AC 50/60 Hz<br><b>Long delay:</b><br>T1 DC<br>T2 AC 50/60 Hz |
| <b>Actuator colour/design</b>                              | A black, long toggle<br>K black, short toggle<br>Z black, without toggle, with slot (only 1-pole)                                                                                                                            |
| <b>other colours to special order</b>                      |                                                                                                                                                                                                                              |
| <b>Marking on actuator</b>                                 | 0 without marking<br>L I-O; ON-OFF<br>N I-O; ON-OFF (IN on housing top)                                                                                                                                                      |
| <b>Auxiliary contacts</b>                                  | H0 without auxiliary contacts<br>H1 with auxiliary contacts, gold-flushed<br>H2 auxiliary contacts, gold-flushed on one pole only (multipole)                                                                                |
| <b>Auxiliary contact function</b>                          | 4 1 change over contact                                                                                                                                                                                                      |
| <b>Auxiliary contact terminal design</b>                   | 2 blade terminal 2.8-0.5 mm                                                                                                                                                                                                  |
| <b>Current ratings</b>                                     | 0.02...50 A                                                                                                                                                                                                                  |
| 8340 - F 1 1 0 - P1 M1 - A L H1 4 2 - 30A ordering example |                                                                                                                                                                                                                              |

**Approvals**

| Authority                          | Standard       | Rated voltage                                     | Current ratings                                                                                     |
|------------------------------------|----------------|---------------------------------------------------|-----------------------------------------------------------------------------------------------------|
| VDE                                | IEC / EN 60934 | AC 240/415 V<br>AC 240 V<br>DC 80 V               | 0.02 A...30 A<br>0.02 A...30 A<br>0.02 A...50 A                                                     |
| UL                                 | UL 1077        | AC 250 V<br>DC 80 V<br>DC 80 V                    | 0.02 A...30 A<br>0.02 A...50 A<br>100 A (2 poles in parallel)                                       |
| CSA                                | C22.2 No 235   | AC 250 V<br>DC 80 V                               | 0.02 A...30 A<br>0.02 A...30 A                                                                      |
| CQC                                | GB 17701       | AC 240/415 V<br>AC 240 V<br>DC 80 V               | 0.02 A...30 A<br>0.02 A...30 A<br>0.02 A...50 A                                                     |
| QPL Sweden Defence Material Admin. | MIL-C-55629    | AC 240 V<br>DC 50 V<br>AC 240 V<br>AC 240 / 415 V | 1 A...30 A (8340-F410)<br>1 A...30 A (8340-410)<br>1 A...30 A (8340-F420)<br>1 A...30 A (8340-F430) |

**Internal connection diagrams**



\*) Other characteristic curves upon request (e.g. pulse delayed, for high inrush currents or capacitive loads)

**Preferred types**

| Preferred types        | Standard current ratings (A) |   |   |   |   |    |    |    |    |    |    |    |    |  |
|------------------------|------------------------------|---|---|---|---|----|----|----|----|----|----|----|----|--|
|                        | 1                            | 2 | 3 | 5 | 8 | 10 | 12 | 16 | 20 | 25 | 30 | 40 | 50 |  |
| 8340-F410-P1K1-KNH0-   | x                            | x | x | x | x | x  | x  | x  | x  |    |    |    |    |  |
| 8340-F410-P1K1-KNH142- | x                            | x | x | x | x | x  | x  | x  | x  |    |    |    |    |  |
| 8340-F410-P1M1-KNH0-   | x                            | x | x | x | x | x  | x  | x  | x  |    |    |    |    |  |
| 8340-F410-P1M1-KNH142- | x                            | x | x | x | x | x  | x  | x  | x  |    |    |    |    |  |
| 8340-F410-K4K1-KNH0-   |                              |   |   |   |   |    |    |    |    | x  | x  | x  | x  |  |
| 8340-F410-K4K1-KNH142- |                              |   |   |   |   |    |    |    |    | x  | x  | x  | x  |  |
| 8340-F410-K4M1-KNH0-   |                              |   |   |   |   |    |    |    |    | x  | x  | x  | x  |  |
| 8340-F410-K4M1-KNH142- |                              |   |   |   |   |    |    |    |    | x  | x  | x  | x  |  |

**Dimensions**

**Flange mounting  
Configuration: F4**

Actuator: long toggle



Actuator: short toggle

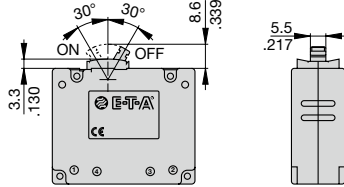

Actuator: without toggle, with slot

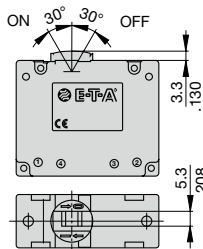

Applicable for nominal dimensions without direct tolerance indication:  
DIN ISO 286 ± IT13

number of poles: 1-3



Cut-out dimensions  
max. panel thickness: 3 mm

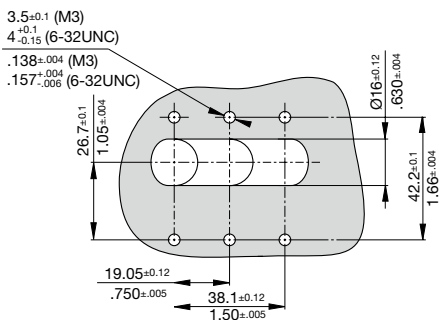

**Configuration: F9**

Actuator: long toggle

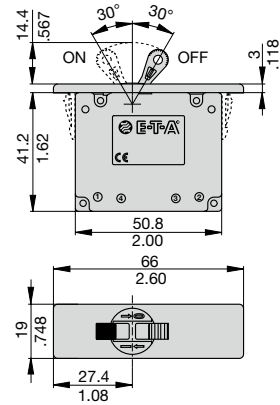

Actuator: short toggle

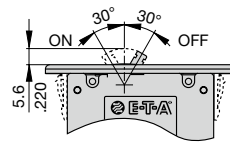

Actuator: without toggle, with slot

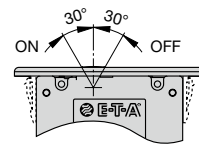

number of poles: 1-3



Cut-out dimensions  
max. panel thickness: 2 ± 0.1 mm or 4 ± 0.15 mm  
(snap-fit)



Applicable for nominal dimensions without direct tolerance indication:  
DIN ISO 286 ± IT13

This is a metric design and millimeter dimensions take precedence ( $\frac{\text{mm}}{\text{inch}}$ )

**Actuator configuration**

**Actuator design**

number of poles: 1 - 3  
Configuration: F4

**Actuator long**

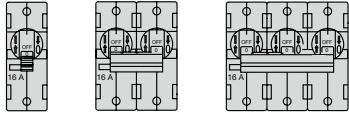

**Actuator short**

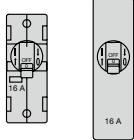

number of poles: 1 - 3  
Configuration: F9

**Actuator long**

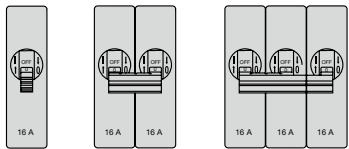

number of poles: 1  
Configuration: F4 / F9

Actuator: Z (black, without toggle, with slot)

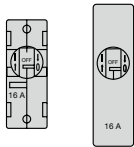

**Terminal design / Dimensions**

**K4 screw terminals M5**  
tightening torque max. 1.2 Nm

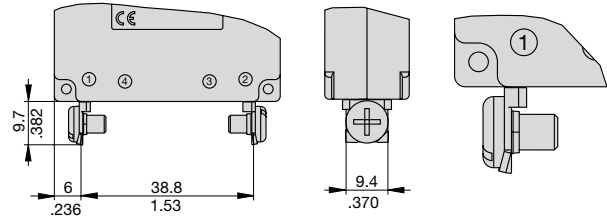

**P1 blade terminals**

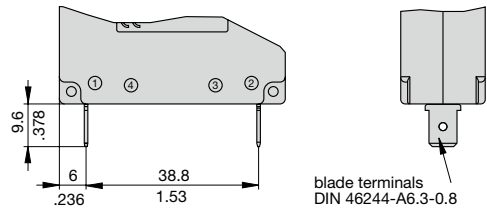

**Auxiliary contacts**

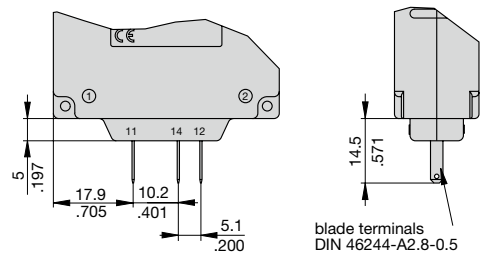

**Shock directions / Mounting attitudes**

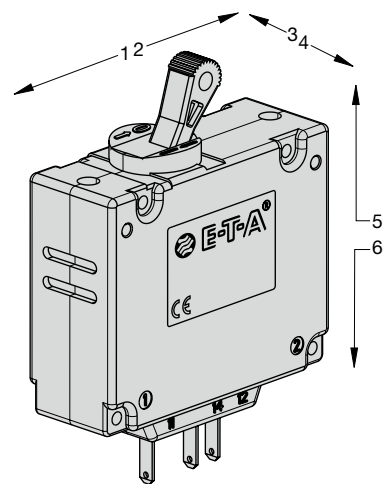

**Installation drawing**

**Terminal design K**

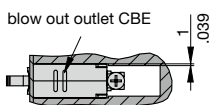

**Terminal design P**

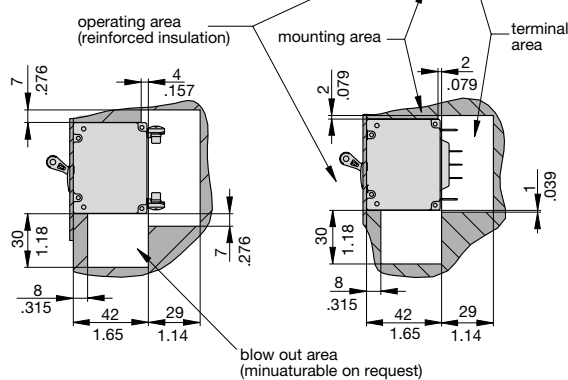
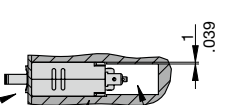

Trip time values indicated for front mounting on a vertical even surface

This is a metric design and millimeter dimensions take precedence ( $\frac{mm}{inch}$ )

Typical time/current characteristics at 23 °C / +73.4 °F

**Curve F1 (instantaneous) for DC**

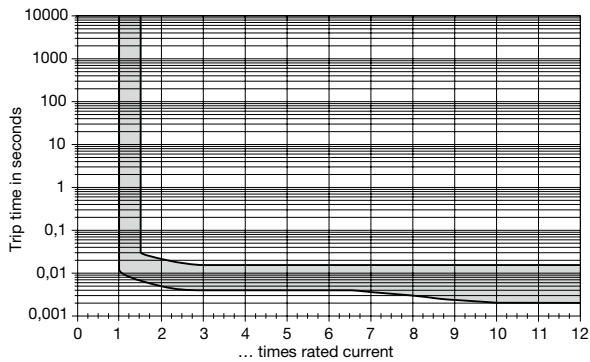

**Curve F2 (instantaneous) for AC**

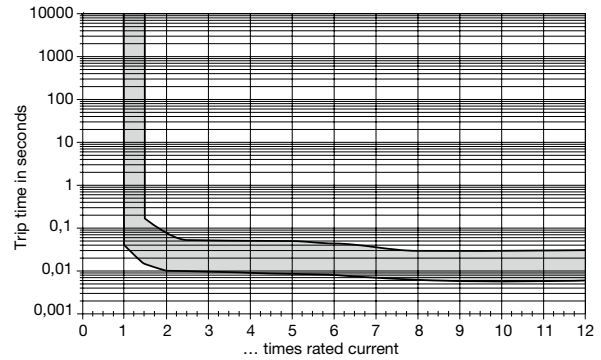

**Curve K1 (short delay) for DC**

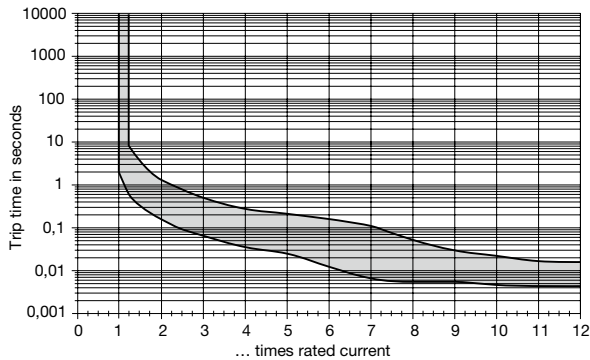

**Curve K2 (short delay) for AC 50/60 Hz**

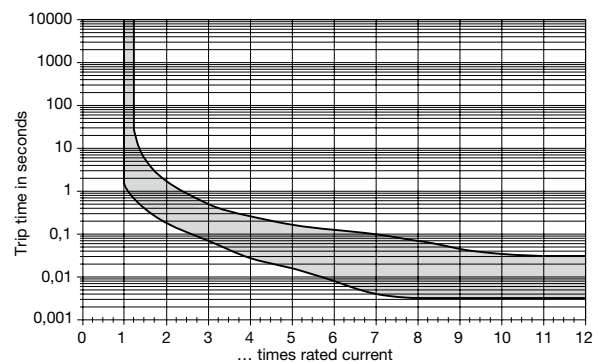

**Curve M1 (medium delay) for DC**

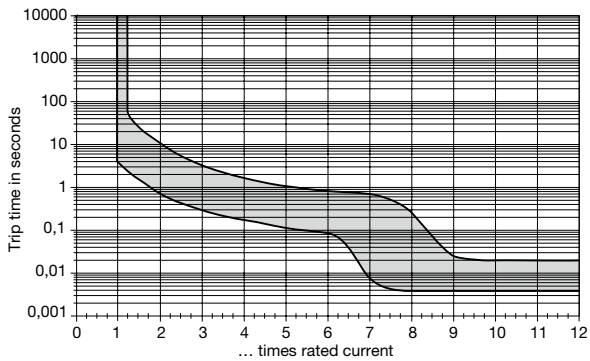

**Curve M2 (medium delay) for AC 50/60 Hz**

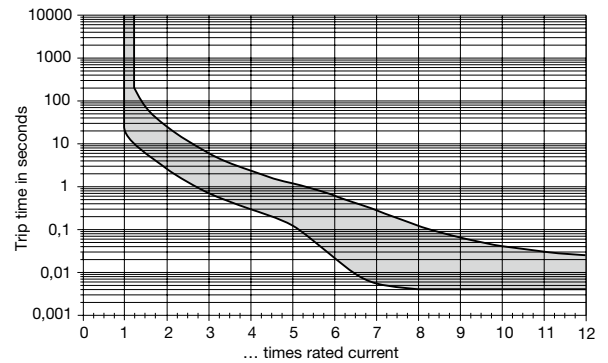

**Curve T1 (long delay) for DC**

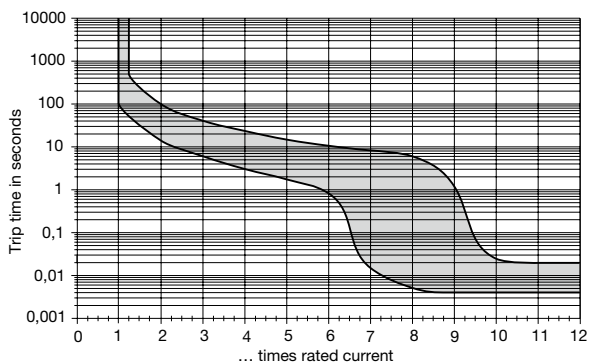

**Curve T2 (long delay) for AC 50/60 Hz**

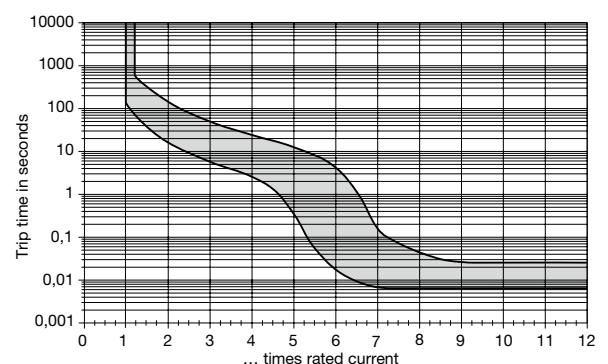

**N.B.** All curves will only be maintained if the escutcheon is mounted on a vertical surface. Ambient temperature or mounting side-by-side does not influence the trip curve, derating is not required. The breakers may trip in the event of current peaks < 0.003 sec. For these applications we offer a mechanical pulse delay – please enquire.

**Other characteristic curves upon request (e.g. pulse delayed, for high inrush currents or capacitive loads).**

1

**Accessories**

**Splash cover with mounting plate and screws  
for 8340-F1.. and 8340-F4**

**1 pole**

**Y 303 565 01**



**2 pole for 8340-F4**

**X 211 118 01**



**3 pole for 8340-F4**

**X 211 119 01**



**Toggle guard for 8340-F1.. and 8340-F4**

**Y 307 250 01**

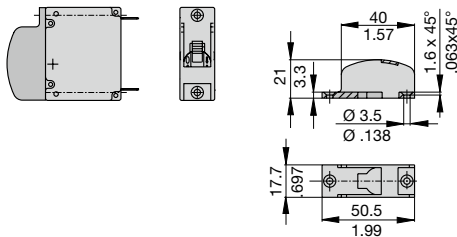

This is a metric design and millimeter dimensions take precedence ( $\frac{mm}{inch}$ )

All dimensions without tolerances are for reference only. In the interest of improved design, performance and cost effectiveness the right to make changes in these specifications without notice is reserved. Product markings may not be exactly as the ordering codes. Errors and omissions excepted.

# Mouser Electronics

Authorized Distributor

Click to View Pricing, Inventory, Delivery & Lifecycle Information:

## E-T-A Circuit Breakers:

[8340-F120-Z7CB-B0H0-744](#) [8340-F130-K3M2-A2H0-10A](#) [8340-F410-P1M1-KLH142-4A](#) [8340-F120-P1M0-A8H0-20A](#)  
[8340-F420-K3T2-KGH0-5A](#) [8340-F910-P1K1-A2H0-25A](#) [8340-F410-P1M1-KLH142-6A](#) [8340-F110-P1M2-A2H142-20A](#) [8340-F110-K4F2-A3H0-40A](#) [8340-F110-P1K1-A2H0-15A](#) [8340-F410-K4M4-A8H0-30A](#) [8340-F410-P1M4-N2H143-16A](#) [8340-F110-K4M1-A0H0-30A](#) [8340-F120-P1T2-B3H0-15A](#) [8340-F110-K2K1-B3H0-30A](#) [8340-F110-P1T2-A2H0-5A](#) [8340-F120-P1T1-A0H0-X031](#) [8340-F110-P1K1-ANH0-6A](#) [8340-F420-P1M2-KLH142-8A](#) [8340-F110-P1F2-C0H142-1A](#) [8340-F120-K4M1-E2H0-12A](#) [8340-F120-P1T2-A0H0-10A](#) [8340-F120-P1M2-A0H0-20A](#) [8340-F110-P1K1-A2H0-10A](#) [8340-F110-P1M1-K2H0-6A](#) [8340-F150-K4F1-KLH0-1A](#) [8340-F410-P1F1-ANH0-5A-U](#) [8340-F410-P1K1-A3H0-5A](#) [8340-F110-P1K1-ALH0-10A](#) [8340-F410-P1M2-A2H0-15A](#) [8340-F440-P1T2-BLH0-10A](#) [8340-F120-K4K2-A3H0-30A](#) [8340-F110-P1M1-K2H0-30A](#) [8340-F410-K2K1-B2H0-25A](#) [8340-F110-P1F2-A0H142-0.1A](#) [8340-F120-Z7CB-B5H0-756](#) [8340-F110-K3F1-ALH0-25A](#) [8340-F410-K4M1-A2H0-50A](#) [8340-F110-P1K1-A2H0-30A](#) [8340-F110-P1M0-HLH0-15A](#) [8340-F110-P1F2-C0H142-0.5A](#) [8340-F110-P1M1-A2H0-10A](#) [8340-F920-P1K2-KLH0-15A](#) [8340-F430-K2M2-A2H0-10A](#) [8340-F120-P1T2-A0H0-5A](#) [8340-F120-K4M0-B2H0-50A](#) [8340-F920-P1M2-ALH0-25A](#) [8340-F120-P1T2-ALH0-4A](#) [8340-F110-P1M2-BLH0-15A](#) [8340-F410-P1M1-A2H0-15A](#) [8340-F410-K2K1-B2H0-10A](#) [8340-F110-X1F1-B8H0-10A](#) [8340-F110-P1K1-ALH0-4A](#) [8340-F120-P1F2-ALH0-30A](#) [8340-F110-P1M1-K2H0-5A](#) [8340-F430-K2M2-A2H0-25A](#) [8340-F120-K3M2-ALH0-30A](#) [8340-F110-P1F8-DLH142-0.1A](#) [8340-F110-K4K1-K8H0-20A](#) [8340-F110-P1T1-A0H0-6A](#) [8340-F910-P1M2-BHH0-15A](#) [8340-F130-K3M2-ANH0-30A](#) [8340-F110-P1K2-B2H142-3A](#) [8340-F110-K4M1-A2H0-50A](#) [8340-F430-K2M2-A2H0-30A](#) [8340-F410-P1K1-ALH142-0.15A](#) [8340-F110-K4M1-A2H0-20A](#) [8340-F130-P1T2-A0H0-6A](#) [8340-F130-P1V2-A8H0-X270](#) [8340-F410-P1M4-M2H143-1A](#) [8340-F120-P1T2-A0H0-3A](#) [8340-F120-P1T2-A0H0-4A](#) [8340-F110-K4K1-A3H142-50A](#) [8340-F120-P1M2-B3H0-5A](#) [8340-F920-P1M2-BHH0-25A](#) [8340-F110-K4T1-K8H0-50A](#) [8340-F410-P1M1-KNH0-15A](#) [8340-F410-K4K1-ALH142-15A](#) [8340-F110-P1F1-B2H0-10A](#) [8340-F420-P1M1-KLH142-3A](#) [8340-F110-P1K1-ALH0-12A](#) [8340-F120-P1M2-BLH0-15A](#) [8340-F110-P1M2-A2H142-10A](#) [8340-F410-P1K1-Z3H0-40A](#) [8340-F120-K3M0-A8H0-35A](#) [8340-F420-P1V2-BLH0-15A](#) [8340-F110-P1F1-A2H142-0.25A](#) [8340-F410-P1K1-K3H0-8A](#) [8340-F130-K3T2-A2H0-25A](#) [8340-F440-P1T2-BLH0-30A](#) [8340-F440-P1T2-BLH0-15A](#) [8340-F110-P1F1-ALH0-0.5A](#) [8340-F120-P1T2-ALH0-3A](#) [8340-F110-P1M1-K2H0-10A](#) [8340-F420-K3K2-ANH0-7A](#) [8340-F410-P1M1-KLH142-2A-U](#) [8340-F110-K3K1-ANH0-6A](#) [8340-F130-K3M2-ANH242-20A](#) [8340-F110-P1F8-NLH142-0.1A](#) [8340-F110-P1M2-KLH0-5A](#)